

# G15A

## Presentation:

The BASS series offers a professional and compact passive and active subwoofers range becoming the perfect choice for sound reinforcement challenges demanding high SPL and natural sounding bass response designed to enhance the ultra-low bass of an existing PA system.

This G15A is built on a Reflex Loaded design equipped with a 15" (4in) LF transducer capable of delivering 1200W AES (4800W peak), chosen to provide clean, undistorted low frequency reproduction at very high sound pressure levels and able to withstand high power levels without damage.

The active version feature a powerful class D single channel amplifier delivering 2400W @ 4ohm connected to a fully programmable DSP providing low-ranging yet clearly defined bass response and rendering impulses with great accuracy in a very compact and robust enclosure. The amplifier module is prepared for universal 85-264Vac mains input and features various electronic protections.

To ensure a perfect matching and avoid undesired vibrations during high SPL operation the enclosures are constructed in 18mm reinforced birch plywood with a rugged and durable polyurea coating. The ergonomic carrying handles permit a secure grip from all sides and convenient transport and all models are prepared to accept 4 swivel castors with 16x M6 inserts on the back. Punch and bass sensation do not have to be incompatible factors and this BASS series truly is a great example.

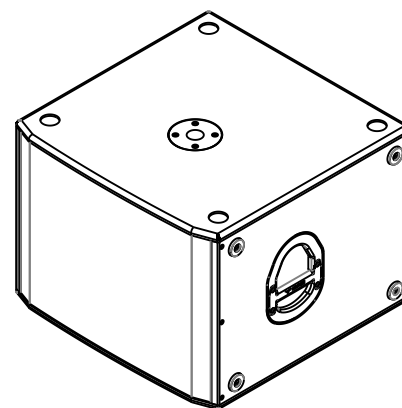

## Features:

- Bass reflex ACTIVE subwoofer
- 1x 15" (4in VC) LF EU transducer
- 1200W AES / 7000W Peak power
- Single channel Class D amplifier with integrated DSP
- Universal 85-264Vac mains. SMPS with PFC
- Versatile, compact and coherent subwoofer
- Made for an impact bass
- Recesses on the top to facilitate the stacking
- Rugged and durable 18mm birch plywood construction
- Powder coated custom perforated steel grille

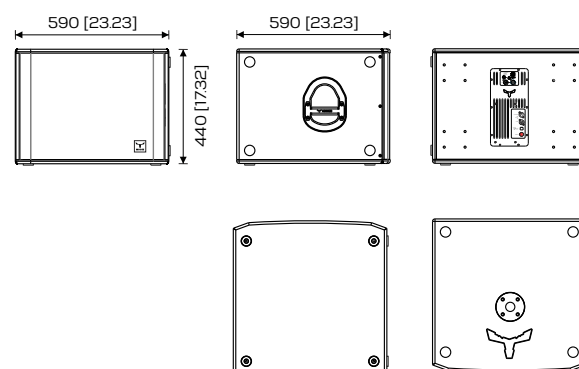

Dimensions in mm [in]

## Technical specifications:

### Acoustical

Type	Compact active subwoofer
Enclosure design	Reflex loaded
Power rating (RMS/Peak)	1200W / 7000W
Frequency range	32 - 250Hz (-10dB)
Nominal impedance	N/A
Transducer type	1x 15" LF (4in VC) EU transducer
Crossover frequency	DSP controlled with selectable presets
SPL (1W/1kHz)	132dB @ 1m
Connector	N/A

### Mechanical

Enclosure	18mm birch plywood, rugged polyurea coating
Grille	Custom perforated metal grilles w/ acoustic foam
Color	Black or white textured
Hardware	4 rubber feet, 2 side handles Ø35mm pole mount socket Prepared for stacking
Dimensions	590x590x440mm   23.23x23.23x17.32in
Weight	38Kg   83.78lb

### Amplifier Module

Type	Single channel Class D
Output Power	2400W / 4ohm
Internal Processing	Fully programmable DSP 48KHz sampling frequency 24 bit AD/DA converter
Audio input/output	XLR/Jack combo connector XLR/M 3p
Indicators	Power, signal/preset, status, clip
Controls	Master level control, 4 selectable presets
AC Mains	SMPS with PFC, 85-264Vac universal mains
AC Mains connector	Neutrik® powerCON, Power-in/Power-out
Protections	Over current, short circuit, thermal, DC and HF

