

GS-853/845/838 series

Supercardoid Conference Dual Gooseneck Microphone

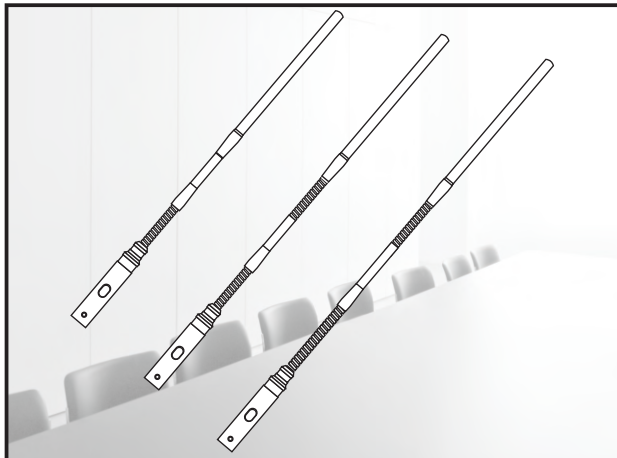

Technical Specifications:

Element	Fixed-charge back plate permanently polarized condenser
Polar Pattern	Cardioid
Frequency Response	30-18,000Hz
Low Frequency Roll-off	100Hz, 16 dB/octave
Sensitivity	-40dB(10.0mV) 1Pa at 1V
Out Impedance	48Ω
Maximum Input Sound Level	127dB SPL, 1 kHz at 1% T.H.D
Dynamic Range(Typical)	102DB, 1 kHz at max. SPL
S/N Ratio	62 db, 1 kHz at 1 Pa
Switch	Flat, roll-off On / Mute
Phantom Power Requirements	12-48V DC
Consumption	5 mA typical
Weight/Dimensions	GS-853: 190g, 530mm GS-845: 170g, 450mm GS-838: 150g, 380mm
Output Connector	Integral 3-pin XLRM-type

- GS-853/845/838 goose-neck microphone is a wide-range condenser super directivity professional microphone with effect of high quality sound pickup. It is designed for television broadcasting, professional recording, meetings and other occasions. Dual gooseneck microphone design, enable to quickly and randomly fix the capsule in a suitable position. Besides that, the equipped snap-on foam windscreen can reduce wind noise and "popping" in speech.

- GS-853/845/838 gooseneck microphone offer excellent anti-interference capability, avoid the interference from the cell phone or other wireless devices. Cardioid microphones pick up sound within 120 degrees of the direction . With the mute switch, users can on/off at any time. And there is an invisible micro-switch can set 100Hz high pass filtering and flat response.

- GS Series microphone is made by durable pure copper, painting with black non-reflective coating. The output connector in the bottom is standard 3-pin XLRM-3 , allowing any conference microphone designed with XLRF-3.

- GS-853/845/838 series conference goose-neck microphone cooperates with super low impedance output balanced audio. Audio signals outputting by NO.2 and NO.3 pin of the XLRM-type and NO.1 pin is for ground wire (shielding) connection. Output phase is designed by positive phase on the NO.2 pin.

- Built-in high pass filter circuit with high quality can help users chose easily the flat frequency response or attenuate sound pickup less than 100Hz. High pass filters can reduce the "popping" from a very close distance in speech and middle & low frequency noise in environment (e.g.: sound of automobile engines from outside, sound of wind in the air conditioning system), echos in the room and mechanical vibrating sounds.

- Output level may be gradually or permanently attenuated when microphone is exposed in the high temperature. Microphone should not be exposed in the sunshine place or places where the temperature is over 45 degree or with high dampness.

Frequency Respod:

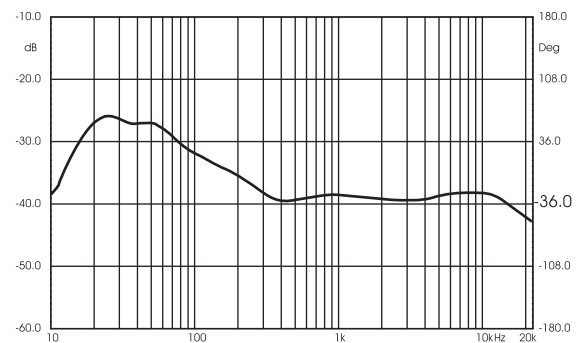

Polar Pattern:

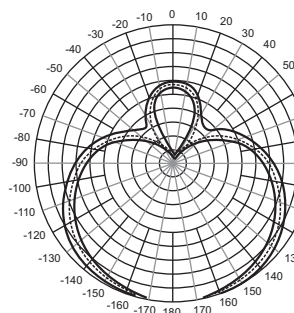

Accessories for selection:

Tabletop shockproof microphone stands: TS-800, TS-700

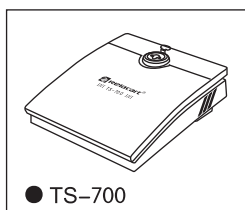
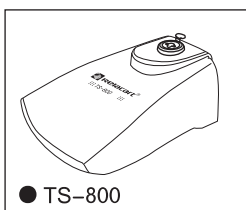

Tabletop shockproof microphone stands with mute switch: TS-800S, TS-700S

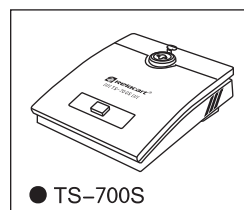
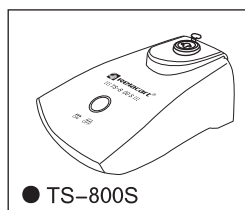

Phantom power supply with mute switch: P-48VIS

