

CDL12P

Constant Directivity Loudspeaker

Owner's Manual

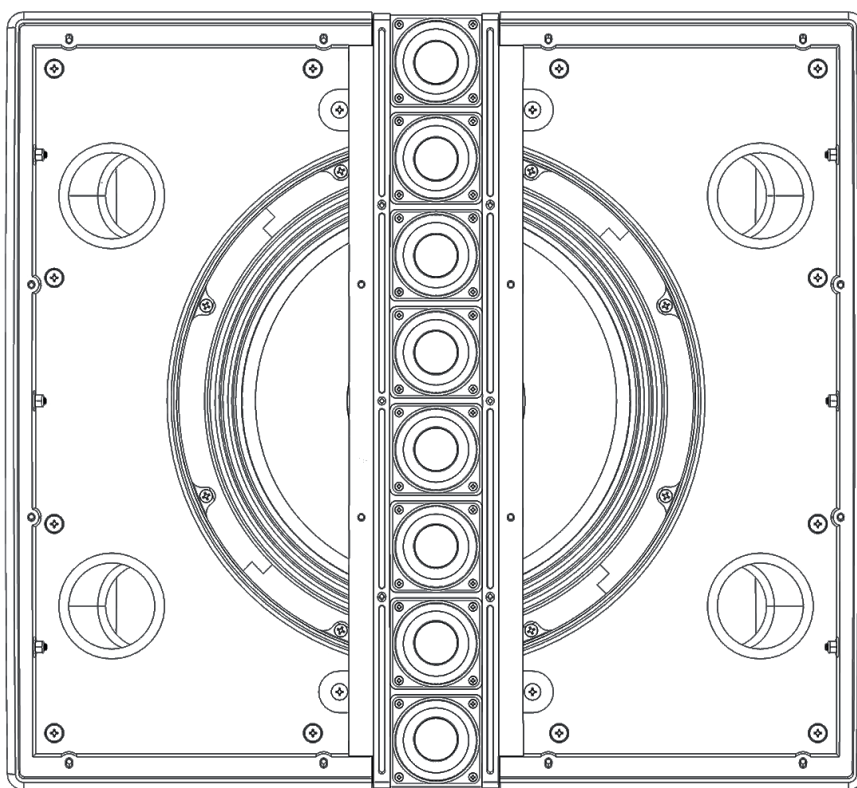

Table of Contents

1 Overview — 1

- 1.1 Introduction — 1
- 1.2 What is in the Box — 2
- 1.3 Rigging Accessories (Sold Separately) — 2

2 Application and Deployment — 3

- 2.1 Getting Started — 3
- 2.2 Cooling — 3
- 2.3 Important Safety Instructions — 4
- 2.4 Rigging Instructions — 5
- 2.5 CDL Rigging Extension Bar Installation Instructions — 6
- 2.6 Suspending the CDL Array — 7
- 2.7 Supported Configurations — 7
 - 2.7.1 Rigging a CDL12P to Another CDL12P — 7
 - 2.7.2 Rigging a CDL12P to a CDL12P Rigging Grid — 7
 - 2.7.3 Using the CDL Rigging Sling with the CDL Rigging Grid — 8
- 2.8 Pole Mounting Options — 8
 - 2.8.1 Important Pole Mounting Safety Instructions — 8
 - 2.8.2 Pole Mounting Instructions — 9

3 Hookup — 10

- 3.1 Rear-Panel Connections and Controls — 10
- 3.2 Onboard Performance Monitoring — 10
- 3.3 Onboard Tuning Features — 10
- 3.4 Power — 11
 - 3.4.1 Connecting Loop-Thru Power — 11

4 Technical Information — 12

- 4.1 Specifications — 12
- 4.2 Mechanical Drawings — 12

1 Overview

1.1 Introduction

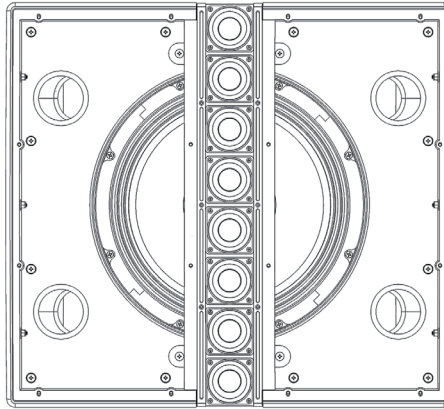

Thank you for purchasing a PreSonus® CDL12P loudspeaker. The CDL12P utilizes a unique design that takes advantage of Constant Directivity Loudspeaker (CDL) technology by placing eight 2-inch high-frequency drivers in a 15° constant curvature vertical array, centered in front of a 12-inch woofer. This allows the CDL12P to radiate sound in a focused directional pattern with up to 90° of vertical coverage when using six boxes rigged together. The CDL12P is a true hybrid of both point-source and line-array speaker designs that combine the beneficial elements of both technologies.

We encourage you to contact us with questions or comments regarding this product. PreSonus Audio Electronics is committed to constant product improvement, and we value your suggestions highly. We believe the best way to achieve our goal of constant product improvement is by listening to the real experts: our valued customers. We appreciate the support you have shown us through the purchase of this product.

1.2 What is in the Box

In addition to this manual, your CDL12P package contains the following:

- (1) CDL12P Loudspeaker

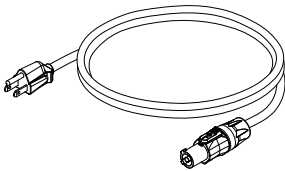
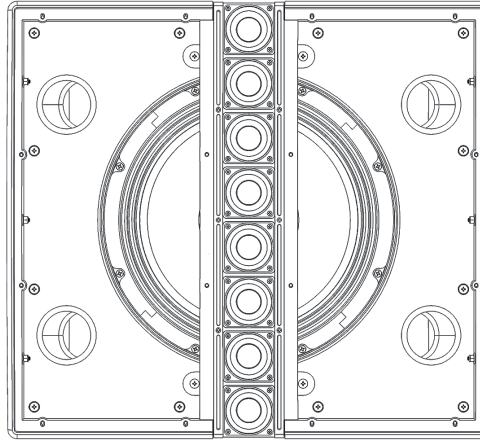

- (1) AC locking 3 conductor 14AWG cord

1.3 Rigging Accessories (Sold Separately)

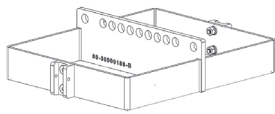

- CDL12P Rigging Grid

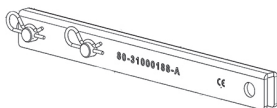

- CDL Rigging Extension Bar



- CDL12P Rigging Sling

2 Application and Deployment

The CDL12P can be configured as an individual point-source loudspeaker or in a vertical array with other CDL12P loudspeakers. Integrated rigging makes easy and secure box-to-box deployment. When suspending two or more arrayed CDL12P loudspeakers, PreSonus requires the CDL12P Rigging Grid. This separately sold rigging grid allows the suspension up to (6) CDL12P loudspeakers. For all supported configurations, *see the chart in Section 2.6*.

Up to two CDL12P loudspeakers may be used on a tripod or on a sub pole over the CDL18s. A single CDL12P may be mounted atop a ULT18, or AIR18 subwoofer (*See Section 2.7 for restrictions and guidelines*). The CDL12P is equipped with a two-position pole-mount to provide more flexible coverage when pole-mounted (0° or 7.5° downward).

IMPORTANT: In all cases, when rigging loudspeakers together, attach the bottommost unit to the loudspeaker directly above it, moving up the grid to the topmost unit, ending with the CDL12P Rigging Grid.

 **WARNING:** The CDL12P weighs 63 lbs. (28.6 kg). Use proper lifting techniques to avoid serious injury. *Please see Section 2.4 for Maximum Suspended Load.*

 **WARNING:** When assembling or disassembling arrayed loudspeakers, make sure that all components are properly supported throughout the entire process to avoid damage or injury.

 **WARNING:** To ensure secure latching, verify that the loudspeakers are properly aligned for box-to-box vertical arraying. If loudspeakers are not properly aligned, physical damage, and personal injury may occur. The top of each loudspeaker should be parallel to the bottom of the unit above it. For suspension, the topmost unit must be securely attached to the CDL12P Rigging Grid.

2.1 Getting Started

Before you begin, here are a few general rules of thumb:

- Always make sure your loudspeakers are powered off when making connections.
- Do not allow your inputs to clip. Watch the Clip LED on the back of your loudspeaker. When this LED illuminates, it indicates that the analog-to-digital converters are in danger of being overdriven. Overdriving the converters causes digital distortion, which sounds terrible.

Your PA and attached equipment should be powered on in the following order:

1. Sound sources (keyboards, D.I. boxes, etc.) connected to your mixer
2. Mixer
3. CDL12P Loudspeakers

When it's time to power down, your system should be turned off in the reverse order.

2.2 Cooling

CDL12P loudspeakers are internally-powered. As such, they utilize a power amplifier that produces heat. Allow a minimum of 6" (152.4 mm) clearance at the rear of the enclosure for cooling. Do not restrict airflow to the rear of the speaker enclosure.

CAUTION: To avoid overheating, do not install enclosures with the amplifier panels exposed to direct sunlight. This can heat the amplifier module and reduce performance. Install sunshades to avoid direct exposure. The maximum ambient temperature for full performance should not exceed 104° F (40° C).

CAUTION: Do not install enclosures where they will be exposed to rain or other moisture. CDL12P loudspeakers are not weatherproof. Protection from the elements must be provided in outdoor installations.

2.3 Important Safety Instructions

WARNING: *Failure to observe the following safety precautions may result in severe injury or death. Installations such as described in this guide should only be attempted by a trained professional.*

- Read these instructions.
- Keep these instructions.
- Heed all warnings.
- Follow all instructions.
- Before installing or suspending any CDL12P loudspeaker, inspect all hardware, the enclosure, and associated equipment for damage. Missing, corroded, or deformed components, or components without correct load ratings, could significantly reduce the strength of the installation or placement and should immediately be repaired or replaced.
- Always make sure that the structure the loudspeaker is to be suspended from has been approved by the building or structural engineer and will support the weight of all the components of the speaker system including speakers, speaker cable, wire rope, etc.
- Consult a licensed professional structural engineer regarding physical equipment installation.
- Do not suspend loudspeakers directly over people.
- Use only hardware that is rated for the load conditions of the installation and that allows for a possible short-term, unexpected overload. Never exceed the rating of the hardware or equipment.
- PreSonus strongly recommends that the system be inspected at least once a year and logged. If any sign of weakness or damage is detected, remedial action should be taken immediately.
- All installation crew members must be trained for loudspeaker rigging and mounting.
- Make sure that all relevant health and safety regulations are known, are followed by the installation crew, and are in compliance with applicable local laws. Local government offices can help with this information.
- Suspended installations must be completed or supervised by a certified rigger.
- The system should be designed so that it is a static suspension. There should be no dynamic or shock loading.
- Personal protective equipment (hard hats, steel-toed footwear, safety glasses, etc.) should be worn at all times by the installation crew.
- If called for in the design, make sure all installation personnel are trained to work at height and have certifications for scissor lifts, theatrical hoists, etc.
- Make sure all lifting equipment (slings, span-sets, deck chain, scaffolding, etc.) is in good working order. Thoroughly inspect all components prior to use.
- Inspect all the components associated with the project for damage before assembly. Any parts with damage or suspected damage should not be used. Contact the component manufacturer for replacement parts if necessary.
- Keep a tidy workplace. Do not leave tools, rigging items, etc., on top of loudspeakers during installation. Loose items can fall and cause injury.
- Never leave the system unattended during the installation process. Make sure that the workspace is isolated from public access. No one should be allowed to pass beneath the loudspeakers during installation.
- Do not suspend any other components or loudspeakers from PreSonus CDL12P loudspeakers other than the supported configurations described in this manual.
- If secondary steel safeties are required, they should be installed once the entire system is at operating height and before public access is allowed.

2.4 Rigging Instructions

CDL12P loudspeakers feature integrated rigging pins. The integrated rigging pins function the same whether you are attaching CDL12P or the CDL12P Rigging Grid.

1. Rotate the pin to the forward 90°.

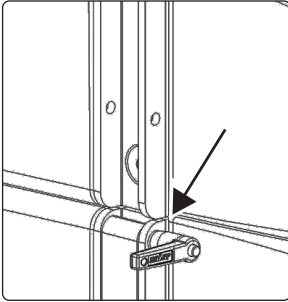

2. Press the release button to unlock the pin.

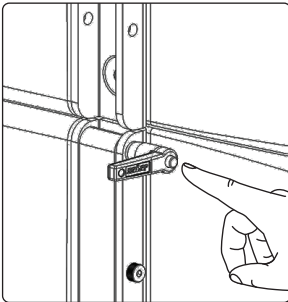

3. Pull out the pin.

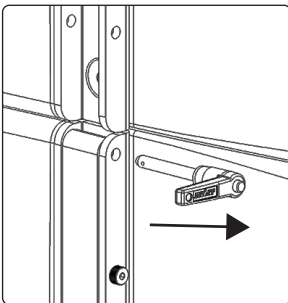

4. Slide the rigging clasp up to attach to the speaker above.

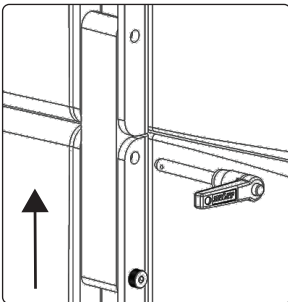

5. Insert the pin into the upper hole of the rigging clasp until it locks, and rotate it up to lock the handle in place.

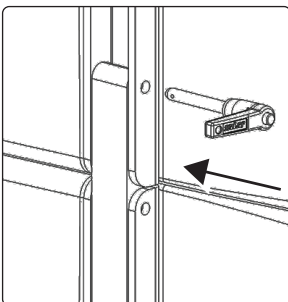

2.5 CDL Rigging Extension Bar Installation Instructions

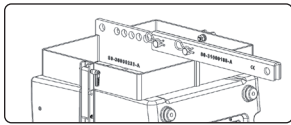

The CDL Rigging Extension Bar is an optional accessory for the CDL12P Rigging Grid that provides upward or downward tilt control for any suspended installation that requires it.

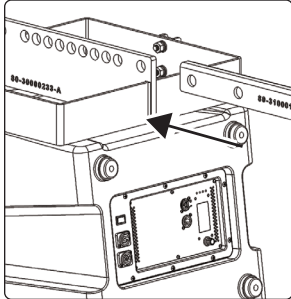

1. Align the CDL Rigging Extension Bar with the center support of the CDL12P Rigging Grid. For downward tilt, the bar should be mounted at the rear of the loudspeaker array. For upward tilt, the bar should be mounted at the front of the array. The illustrations in this section show the downward tilt configuration only.

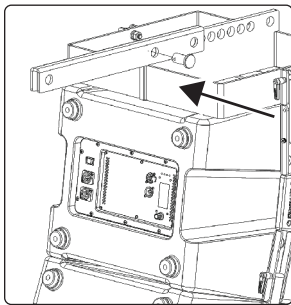

2. Insert the first clevis pin into the outermost through-hole.

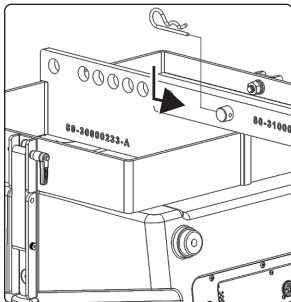

3. Lock the clevis pin in place using a cotter pin.

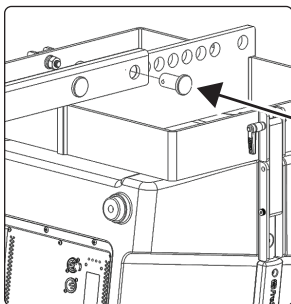

4. Insert the second clevis pin into the inner through-hole.

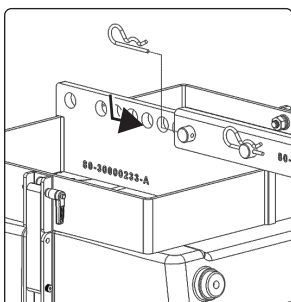

5. Insert a cotter pin into second clevis pin to lock it into place.

2.6 Suspending the CDL Array

WARNING: Consult a professional mechanical or structural engineer, licensed in the jurisdiction of the sound system installation, to review, verify, and approve all attachments to the building or structure. Employ the services of a certified, professional rigger for hoisting, positioning, and rigging the equipment to the supporting structure. Improper suspension can lead to serious damage, injury, or death.

WARNING: Review all safety instructions in Section 2.3.

The table below shows the maximum suspended loudspeaker load configurations. Deploying loudspeakers that exceed the supported configurations below can lead to serious damage, injury, or death. PreSonus has tested the configurations below for safety. Please note that the structure from which you are suspending any CDL12P loudspeaker array must be able to support that total weight.

DO NOT SUSPEND LOUDSPEAKERS DIRECTLY ABOVE THE AUDIENCE

Supported Suspended Loudspeaker Configurations						
Maximum Number of CDL12P Loudspeakers	0	2	3	4	5	6
Individual Component Weight						
CDL12P	CDL12P Rigging Grid		CDL Rigging Grid Extension Bar			
63 lbs (28.6 kg)	24 lbs (10.9 kg)		5.8 lbs (2.6 kg)			

WARNING: All PreSonus CDL12P rigging and rigging accessories are rated for a 10:1 load. Structural suspension supports must also be rated for a 10:1 load.

2.7 Supported Configurations

2.7.1 Rigging a CDL12P to Another CDL12P

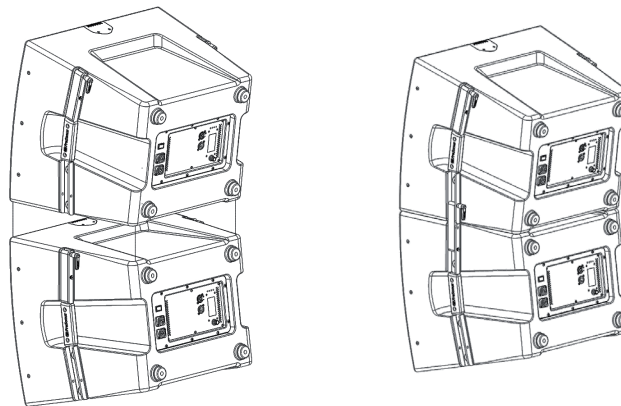

2.7.2 Rigging a CDL12P to a CDL12P Rigging Grid

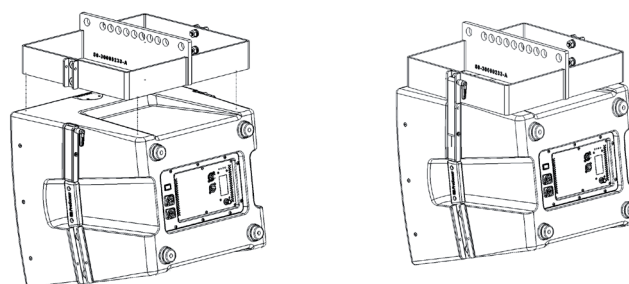

2.7.3 Using the CDL12P Rigging Sling with the CDL12P Rigging Grid

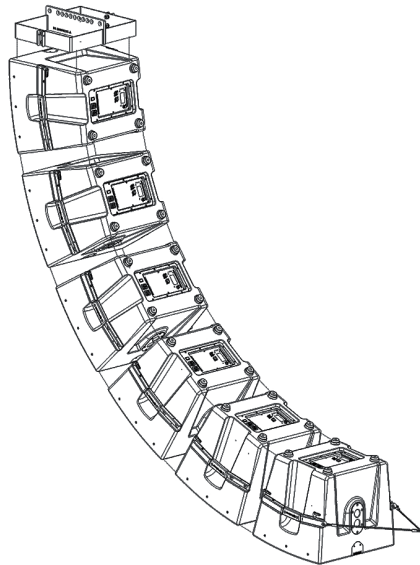

WARNING: The CDL12P Rigging Sling is required on all installations that include 4 or more CDL12P loudspeakers in a vertical array. Additionally, in installations using the CDL Rigging Extension Bar deployed with an upward or downward tilt of 12° or greater, the CDL Rigging Sling must be utilized.

2.8 Pole Mounting Options

You can mount up to two CDL12P loudspeakers on a loudspeaker pole either using a tripod stand that supports the total weight (130 lbs / 58.9 kg) or atop a CDL18s. A single CDL12P may be mounted atop a ULT18, or AIR18. When mounting atop a supported PreSonus subwoofer, utilize a sub pole that supports the total weight of the CDL12 loudspeaker(s). If mounting atop a subwoofer, the elevation height cannot exceed the following guidelines:

Maximum Sub Pole Height		
(1) CDL12P + (1) CDL18s, ULT18, or AIR18s	(2) CDL12P + (1) CDL18s	(1) CDL12P + (2) CDL18s
40"	33.5"	17"

2.8.1 Important Pole Mounting Safety Instructions

- Always check the stand or pole specification to verify that it is designed to support the weight of the CDL12P loudspeaker(s).
- Always observe all safety precautions specified by any 3rd party manufacturer of devices used with the CDL12P loudspeakers.
- Always verify that the stand or subwoofer and subwoofer pole is resting on a level, flat, and stable surface.
- Tripod legs should be fully extended for maximum stability and positioned in a low-traffic area so that the legs do not create a tripping hazard.
- Route cables so that no one will trip over them as this could topple the speaker and cause serious injury, damage, or death.
- Stands, poles, and associated hardware should be inspected prior to each use. Do not use equipment with worn, damaged, or missing parts.
- For some applications, it may be necessary to place additional weights, such as sandbags, on the base of the stand to for maximum stability.
- Do not attach banners to the stand as these could function like a sail to topple the system, causing serious injury, damage or death.

2.8.2 Pole Mounting Instructions

1. Select the pole socket angle for your application (0° or 7.5°).
Note: When mounting (2) CDL12P loudspeakers, the 7.5° tilt mount must be utilized.
2. Carefully place one CDL12P on the loudspeaker pole by inserting the pole completely into the pole socket.
3. If mounting (2) CDL12P loudspeakers on one pole, place the lower loudspeaker on the pole first, then rig the top one to it following the instructions in **Section 2.8.1**.



Important: Use proper lifting techniques to avoid injury. It is highly recommended that you team lift CDL12 loudspeakers onto their pole mount for maximum safety and to avoid injury.

The following pole mounting options are supported:

- (1) CDL12P on Tripod Stand
- (2) CDL12P on Tripod Stand



WARNING: The (2) CDL12P loudspeakers must be rigged to one another. See **Section 2.8.1** for instructions.

- (1) CDL12P atop (1) CDL18s, (1) ULT18, or (1) AIR18s



WARNING: Maximum pole height from the top of the CDL18s to the bottom of the CDL12P cannot exceed 40". PreSonus recommends the K&M 21339.000.55 Crank Stand.

- (1) CDL12P atop (2) CDL18s



WARNING: Other stacked subwoofer configurations are not supported. Maximum pole height from the top of the upper CDL18s to the bottom of the CDL12P array cannot exceed 17". PreSonus recommends the K&M 21334.050.55 Distance Rod.

The (2) CDL18s must be rigged to one another. See **CDL12P Owners Manual** for instructions.

- (2) CDL12P atop (1) CDL18s



WARNING: PreSonus only supported pole mounting (2) rigged CDL12P atop a PreSonus CDL18s subwoofer. No other subwoofers are supported for this application. The maximum pole height from the top of the CDL18s to the bottom of the CDL12P cannot exceed 33.5". PreSonus recommends the K&M 21339.000.55 Crank Stand.

The (2) CDL12P must be rigged to one another. See **Section 2.3.1** for instructions.

3 Hookup

3.1 Rear-Panel Connections and Controls

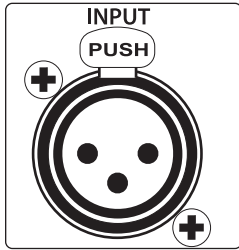

Line Input. This is a balanced XLR connection for line-level input. Use the Line input to connect the loudspeaker to a StudioLive digital mixer or another mixing console, either directly or through the Line out connector on another CDL12P loudspeaker.

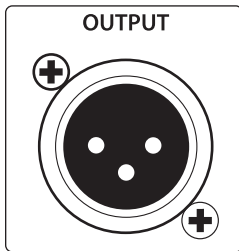

Direct Out. This is the Direct Out for the line input. Use this to connect to another CDL12P loudspeakers.

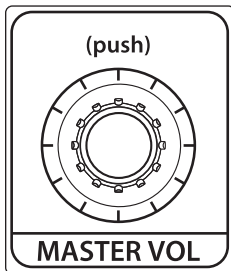

Master Vol. This knob determines the master output level (volume) of the subwoofer power amplifier. It has no effect on the signal level from the direct output. Push this control to access all the DSP functions in your CDL12P loudspeaker.

Power User Tip: A subwoofer can significantly change the frequency response of a full-range system. A 3-way system with a subwoofer will be 6 to 18 dB hotter below 80 to 100 Hz. Set the appropriate level for your subwoofer before adjusting your system EQ.

3.2 Onboard Performance Monitoring

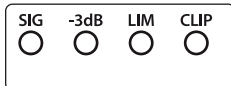

Master Performance Monitoring. These 4 LEDs display the performance status of the internal amplifier:

- **SIG.** This LED illuminates when the input signal exceeds -50 dB.
- **-3 dB.** When this LED illuminates, the input signal has exceeded -3 dB.
- **LIM.** The protection limiter has been engaged when this indicator illuminates.
- **CLIP.** The clip LED illuminates when the input signal has exceeded 0.5 dBFS, and the ADC is clipping, or when the amplifier exceeds the maximum upper limit (load dependent).

Power User Tip: Never run your input levels higher than the channel inputs can handle. If you overdrive the A/D converters, it will cause digital distortion (digital clipping), which sounds terrible.

3.3 Onboard Tuning Features

The CDL-12P loudspeaker make it easy to customize the loudspeaker's performance for your application. To access the controls, simply press the Master level encoder and turn it to scroll through the menu options. Press the encoder again to select a parameter and adjust it. Press again to continue scrolling.

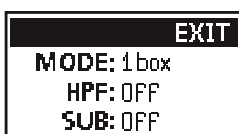

Mode. This selects a preset optimized for configurations. Select the configuration preset for the number of CDL12P loudspeakers arrayed together (1 box to 6 boxes).

HPF. Engages/disengages the onboard 90 Hz High Pass Filter.

Sub Mode. Adjusts the crossover frequency and the delay for the companion PreSonus subwoofer being used (CDL18s, ULT18, or AIR18s). When using the CDL12P without a subwoofers, select "Off"

Brightness. Adjusts the brightness of the display.

Contrast. Adjusts the contrast of the display.

System Reset. Resets the system settings to factory default.

System Info. Opens the System Information screen.

Exit. Select to return to the Level screen. You will be given the option to save any changes you've made to the DSP settings before exiting.

3.4 Power

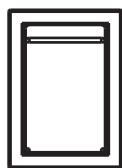
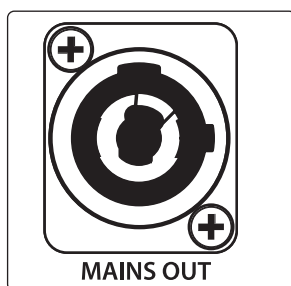
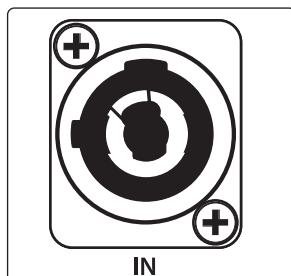

POWER
On/Off

AC Line Connection. CDL12P loudspeakers have a universal power with a voltage range of 100-120VAC, 50-60Hz. Each loudspeaker is supplied with a locking 3-conductor AC power cord appropriate for the country of sale.

WARNING: Do not remove the center grounding prong or use a ground-lift adapter, as this could result in electric shock.

WARNING: Connect the power cord to the AC In connection on the amplifier *before* connecting the IEC connection to the AC mains power source.

Power Thru. CDL12P loudspeakers provide loop-thru power. Using locking 3 conductor Loop-thru cables, you can power up to six CDL12P loudspeakers.

Loop-thru cable connectors are color coded as follows:

- **Blue.** AC In.
- **White.** AC Out.

Power Switch. This is the On/Off switch.

Power User Tip: If connecting multiple loudspeakers to the same electrical circuit, make sure that adequate line current is available. Maximum current draw for each CDL12P loudspeaker is 5.45 Amps.

WARNING: The power switch does not cut AC mains power from the loop-thru cables. If AC mains power is connected to one CDL12P loudspeaker, electrical power will be present on all connected loop-thru cables.

3.4.1 Connecting Loop-Thru Power

1. Begin by inserting the white connector on the loop-thru cable into the white AC Out connection on the power amplifier.
2. Once the cable is fully seated, twist the connector clockwise to lock it into place.
3. Insert the blue connector into the blue AC In connection on the other CDL12P power amplifier.
4. Once the cable is fully seated, twist the connector clockwise to lock it into place.

Repeat Steps 1-4 for the other loudspeakers you'd like to power.

4 Technical Information

4.1 Specifications

Type	Active 2-way
LF Driver	12" (2.5" Voice Coil)
HF Driver	8x 2" (1" Voice Coil)
Amplifier Type	Class D
Total System Power	2000W Peak, 1000W Program (500W RMS)
LF Driver Power	1000W Peak, 500W Program (250W RMS)
HF Driver Power	1000W Peak, 500W Program (250W RMS)
Frequency Range (+/- 3dB)	48 Hz – 18 kHz
Crossover Frequency	420 Hz
Maximum Peak SPL	130 dB
Horizontal Coverage	120°
Vertical Coverage	15° per enclosure
Input	Line (XLR)
Output	Direct Line Out (XLR)
Mains Connection	Locking 3 conductor AC connector In and Out
DSP Functions	HPF On/Off, No. arrayed boxes, PreSonus subwoofer configuration preset
Indicators	Signal, -3 dB, Limiter, Clip
Enclosure	15 mm Polypropylene
Mounting	Dual-position pole mount (0° and 7.5°), Integrated Rigging (10:1 load)
Dimensions (H x W x D)	18.6" x 20.8" x 17.5" (473 mm x 529 mm x 444.5 mm)
Weight	63 (28.6 kg)
Optional Accessories	CDL12-Tote Tote Bag

4.2 Mechanical Drawings

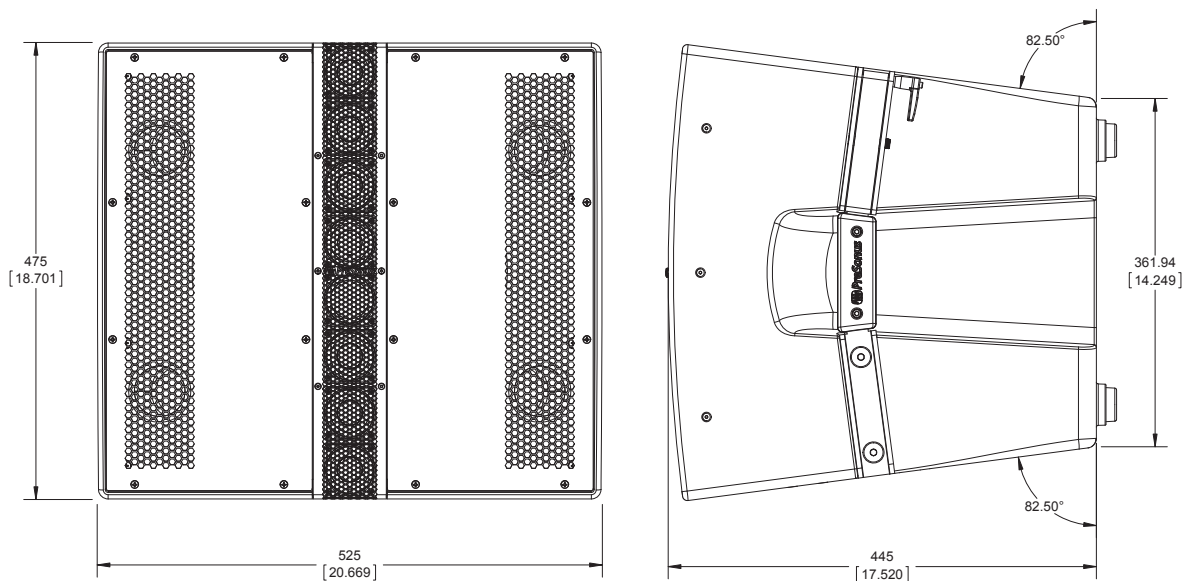

Added bonus: PreSonus' previously Top Secret recipe for...

Redfish Couvillion

Ingredients:

- ¼ C Vegetable oil
- ¼ C flour
- 1 onion diced
- 1 clove garlic minced
- 1 green pepper diced
- 3 celery stalks diced
- 1 14oz can diced tomatoes
- 1 bottle light beer
- 2 bay leaves
- 1 tsp thyme
- 2 lbs Redfish fillets

Cooking Instructions:

1. In a heavy saucepan or large skillet, heat oil on medium high and slowly add flour a tablespoon at a time to create a roux. Continue cooking the roux until it begins to brown, creating a dark blond roux.
2. Add garlic, onions, green pepper, and celery to roux.
3. Sauté vegetables for 3-5 minutes until they start to soften.
4. Add tomatoes, bay leaves, thyme, and redfish. Cook for several minutes.
5. Slowly add beer and bring to a low boil.
6. Reduce heat and simmer uncovered for 30-45 minutes until redfish and vegetables are completely cooked, stirring occasionally. Break up redfish into bite size chunks and stir in. Add pepper or hot sauce to taste. Do not cover.
7. Serve over rice

Serves 6-8

While not one of Southeast Louisiana's more famous dishes, Redfish Couvillion is a favorite way to serve our favorite Gulf fish. Also known as Reds or Red Drum, Redfish is not only fun to catch, it's also delicious!

CDL12P

Constant Directivity Loudspeakers

Owner's Manual

