

Instruction manual

Digital Conference System

ATUC-50

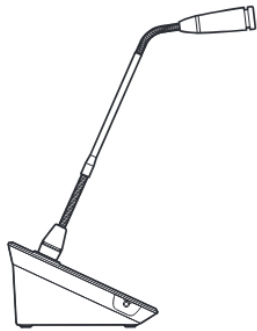

Gooseneck Microphone with LED Ring
ATUC-M43H/58H

Discussion Unit
ATUC-50DU

Interpretation Unit
ATUC-50INT



Control Unit
ATUC-50CU

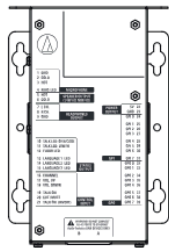

Integration Unit
ATUC-50IU



Link Extender
ATLK-EXT165

 **audio-technica**®

Table of Contents

Introduction	4
About this manual.....	4
About the information in this manual	4
About registered trademarks and copyrights	4
Included accessories for the ATUC-50CU	4
Included accessories for the ATUC-50IU	4
Included accessories for the ATLK-EXT165	4
System placement	5
Installing the CU(s) in a rack.....	5
Unbalanced connection.....	5
AC power cord connection.....	5
When cleaning the units.....	5
ATUC-50 System	6
Features	6
Features of ATUC-50 system	6
About Audio-Technica LINK.....	6
Features of ATUC-50CU.....	6
Features of ATUC-50DU/INT	6
Features of ATUC-50IU	6
Features of ATLK-EXT165.....	7
Features of ATUC-M43H/58H.....	7
Optional products (sold separately by Audio Technica)	7
Connection example of digital conference system ATUC-50.....	8
Part Names and Functions	9
ATUC-50CU.....	9
Front panel.....	9
Rear panel.....	11
ATUC-50DU	12
ATUC-50INT.....	13
Common to ATUC-50DU/INT	14
ATUC-M	14
ATUC-50IU.....	15
ATLK-EXT165.....	21
Changing settings from ATUC-50CU	22
Entering letters	23
Overview of the Interpretation Unit (ATUC-50INT)	24

System Connections and Configuration	26
Connecting devices	26
1 Connecting the DUs/INTs to the CU.....	26
2 Connecting the DUs/INTs together	27
3 Connecting the microphone ATUC-M to the DU/INT	30
4 Connecting an amplifier	30
5 Turning on the CU and testing DU operations	30
6 Connecting to a network	31
7 Connecting a computer or mobile device to a network..	31
Preparing to use Web Remote	33
What is Web Remote?.....	33
Setting up "Locate"	33
Configuring and Operating Conferences Using the Web Remote Control Function	34
About Web Remote	34
Overall structure of Web Remote	34
Starting up Web Remote and preparing for operations.....	35
Starting up and logging in to Web Remote.....	35
About Web Remote Home screen	35
Configuring detailed system settings ([Settings & Maintenance])	36
How to operate the [Settings & Maintenance] menu	36
Menu item ① ([System Settings])	37
Menu item ② ([Install Settings]).....	42
Accessing your presets ([Presets])	54
Log management ([Logging])	54
Displaying the system information ([System Info]).....	54
Preparing for conferences ([Setup Conference])	55
1 Recalling the preset ([Recall Preset])	55
2 Changing the conference settings ([Conference Settings])	55
3 Adjusting the DU/IU settings ([DU/IU Settings], [DU/IU Detail Settings])	56
Operating and controlling conferences ([Start Conference])	57
1 Operating conferences ([Conference Manager]).....	57
2 Configuring the advanced audio-related settings and performing audio operations ([Audio Control])	58
3 Configuring conference settings ([Conference Settings])	58

Information.....	59
Troubleshooting	59
ATUC-50CU	59
ATUC-50DU/INT.....	60
Web Remote	61
ATUC-50IU	61
ATLK-EXT165.....	61
Error messages	62
Specifications	66
ATUC-50CU specifications.....	66
General specifications	66
Input/output specifications	67
ATUC-50DU/INT specifications	68
General specifications	68
Input/output specifications	69
ATUC-50IU specifications.....	70
General specifications	70
ATLK-EXT165 specifications.....	72
General specifications	72
ATUC-M specifications	73

Introduction

About this manual

About the information in this manual

The images and screenshots shown in this manual may differ from the actual product.

Device names

The device names are abbreviated as follows.

- CU: "Control Unit" ATUC-50CU
- DU: "Discussion Unit" ATUC-50DU
- INT: "Interpretation Unit" ATUC-50INT
- ATUC-M: "Gooseneck Microphone with LED Ring" ATUC-M43H/ATUC-M58H
- IU: "Integration Unit" ATUC-50IU
- EXT: "Link Extender" ATLK-EXT165

Symbols

- › Indicates the page(s) where you can find more detailed or related information.
- NOTICE** Indicates a risk that may result in malfunction or damage to the device.
-  Indicates supplementary information as well as tips & advice for operations.
- [] Indicates menu items on the Web Remote screen.

Operations on mobile devices

Operations in this manual assume that you are using a computer as a control device. Alternatively you can use a mobile device such as a tablet. Instead of clicking or double-clicking, operate the application by tapping.

About registered trademarks and copyrights

- Apple, the Apple logo, iPad and Mac OS are trademarks of Apple Inc., registered in the U.S. and other countries. App Store is a service mark of Apple Inc.
 - Google Play and the Google Play logo are registered trademarks or trademarks of Google Inc.
 - Other product names, service names, logos and/or company names used in this manual are trademarked and copyrighted properties of their respective owners and/or licensors.
- In this manual, the TM and ® mark may not be specified.

Included accessories for the ATUC-50CU

The following accessories and documentation are provided.

- AC power cord
- Euroblock connector (9 pieces)
- Quick Setup Guide—English version
- Quick Setup Guide—Multi-language version

Included accessories for the ATUC-50IU

The following accessories and documentation are provided.

- Euroblock connector (13 pieces (Green x 3, Black x 10))
- Quick Start Guide—Multi-language version

Included accessories for the ATLK-EXT165

The following accessories and documentation are provided.

- Euroblock connector
- Power cable
- Table mount kit (Table mount x 2, Screw x 4)
- Quick Start Guide—Multi-language version

System placement

Installing the CU(s) in a rack

Rack requirements for the CU

- EIA standard compatible 19-inch rack
- 1U-size rack mounting
- Rack equipped with safety guardrails to support the CU and a board on which the CU is to be placed

When installing the CU(s) in a rack, keep the temperature within the rack below 45°C (113°F). High temperature may damage the internal components, causing a malfunction.

Leave a space of 10cm or more on each side (top, right and left, rear) between the CU and other devices or the rack.

Rack mounting angles are fixed to the CU using the following screws. When using screws other than those listed here, check the specifications.

- S TIGHT tapping screws with nominal diameter 4×6mm*
* Substitutable for M4×6mm machine screws

Unbalanced connection

Since induction noises tend to occur due to difference in electric potential of chassis:

- Keep the chassis between each device at the same electric potential.
- Use the same power system.
- Connect to the GND (ground) terminal or chassis ground of each device.

AC power cord connection

Be sure to connect the AC power cord into a properly grounded wall outlet. Improper grounding can cause electrical shock.

When cleaning the units

Do not use any solvents or chemicals such as benzene, thinner, alcohol or electrical contact cleaner and protector. Doing so may cause deformation, damage and malfunction of the units.

ATUC-50 System

Features

Features of ATUC-50 system

- Audio processing by the feedback processor and the like enables clear-sounding conversations
- Up to 6 interpretation units (ATUC-50INT) can be connected.
- The maximum number of discussion unit (ATUC-50DU), integration unit (ATUC-50IU), and interpretation unit (ATUC-50INT) connections is 300 (with 3 CU Links)
- Either daisy-chain or ring connection can be made with Cat5e or higher cables (shielded cables with conductor size of 24AWG or higher in diameter are recommended).
- 3 selectable conference modes: Free Talk Mode, Request Talk Mode, and Full Remote Mode
- 2-language interpretation, 3-language interpretation, and 3-language relay interpretation are supported (ATUC-50INT)
- The recording function enables you to record audio onto a USB device (mass storage device)
- Controllable using Web Remote and an external control device
- Design with future expansion considered

About Audio-Technica LINK

The system adopts the unique format Audio-Technica LINK for power supply and signal transmission between the control unit(s) (ATUC-50CU), discussion unit(s) (ATUC-50DU), etc.

Audio-Technica LINK is compatible with the Ethernet standards and allows a simple construction for universal Cat5e or higher cable connections. (A shielded cable with conductor size of 24AWG or higher in diameter is recommended.) Transmission of high-speed signals with low-latency allows stable control and uncompressed audio signal transmission.

Features of ATUC-50CU

- Power supply and control is possible for a maximum of 100 discussion units (ATUC-50DU) (depending on the cable lengths ATLK-EXT165 may be required)
- Up to 300 conference microphones (ATUC-50DU + ATUC-M) can be connected by cascade-connection
- 4 configurable balanced matrix output plus 1 unbalanced output that outputs the same audio as Output 1
- 2 Mic/Line inputs, 2 monaural AUX inputs, and 2 return inputs
- 2 return channels are available for both bilingual simultaneous interpretation and the language of the floor holder
- Conference mode: Free Talk, Request Talk, and Full Remote
- Priority mode: First-press priority and later-press (FIFO, LIFO) priority

- Talk mode: Manual mode, Voice activation mode
- Web Remote enables you to easily change settings and control attendees' right to talk during conference
- Up to 4 channels (WAV: up to 4 channels, MP3: up to 2 channels) can be recorded on a USB device (mass storage device)
- Audio processing by the feedback suppressor and the like enables the control unit to deliver high-quality sound
- Design with future expansion and renewal considered

Features of ATUC-50DU/INT

- An LED ring enables power supply via 3-pin balanced connector while offering both high sound quality and user flexibility
- ATUC-M and standard 3-pin microphone can be connected
- A microphone amplifier with discrete transistors reduces noise; moreover individual gain is adjustable
- A high-quality and high-resolution speaker
- Designed for the high sound qualities of 24 bit/48 kHz
- Multiple independent indicators (ATUC-M ring LED, multicolored LEDs both on the rear side and on the Ⓢ (talk) button)
- High-visibility indicators associated with the headphone volume adjustment buttons and monitor channel selection buttons
- Optional removable bottom weight for improved stability
- 2 RJ-45 terminals for connecting discussion units (ATUC-50DU); 1 expansion RJ-11 terminal for future expansions
- 1 headphone output jack with a monitoring channel switch function

Features of ATUC-50IU

- Discussion units that can be embedded in the ATUC-50 system
- Configure the system simply by connecting the microphones, speakers, headphones, etc.
- GPIO control terminal built in for monitoring conditions and controlling external devices
- Equipped with 2 RJ-45 terminals for connecting discussion units (ATUC-50DU), etc.
- Designed for the high sound qualities of 24 bit/48 kHz
- Integration unit (ATUC-50IU) can be set from the web remote for the chairperson/delegate names
- Conference Mode and volume can be set for each integration unit (ATUC-50IU)

Features of ATLK-EXT165

- Connects to any Audio Technica device, such as a control unit (ATUC-50CU), or discussion unit (ATUC-50DU), and is equipped with two RJ-45 terminals that can expand the discussion system
- Remote mode that automatically starts from the control unit (ATUC-50CU)
- Has a standalone mode that can be started by operating the front panel
- Equipped with GPO terminal that notifies external devices when an overcurrent (2.6 A) is detected in the power supplied from RJ-45 terminals

Features of ATUC-M43H/58H

- Equipped with an LED ring that enables power supply via 3-pin balanced connector while offering both high sound quality and user flexibility
- Adopted mechanics between the microphone connector and the discussion unit (ATUC-50DU) reduce vibration
- Adopted a double layer pop filter (windscreen inside the microphone)
- Improves RF measures against external radio waves
- 2 types of microphones (430mm and 580mm length)

Optional products (sold separately by Audio Technica)

Model number	Name	Use
ATUC-DUWT	DISCUSSION UNIT WEIGHT PLATE	Use this to improve the reliability of installation for the discussion unit (ATUC-50DU).
AT8643	RACK MOUNT KIT	Use this when rack mounting half-rack sized products, such as link extenders (ATLK-EXT165).

Connection example of digital conference system ATUC-50

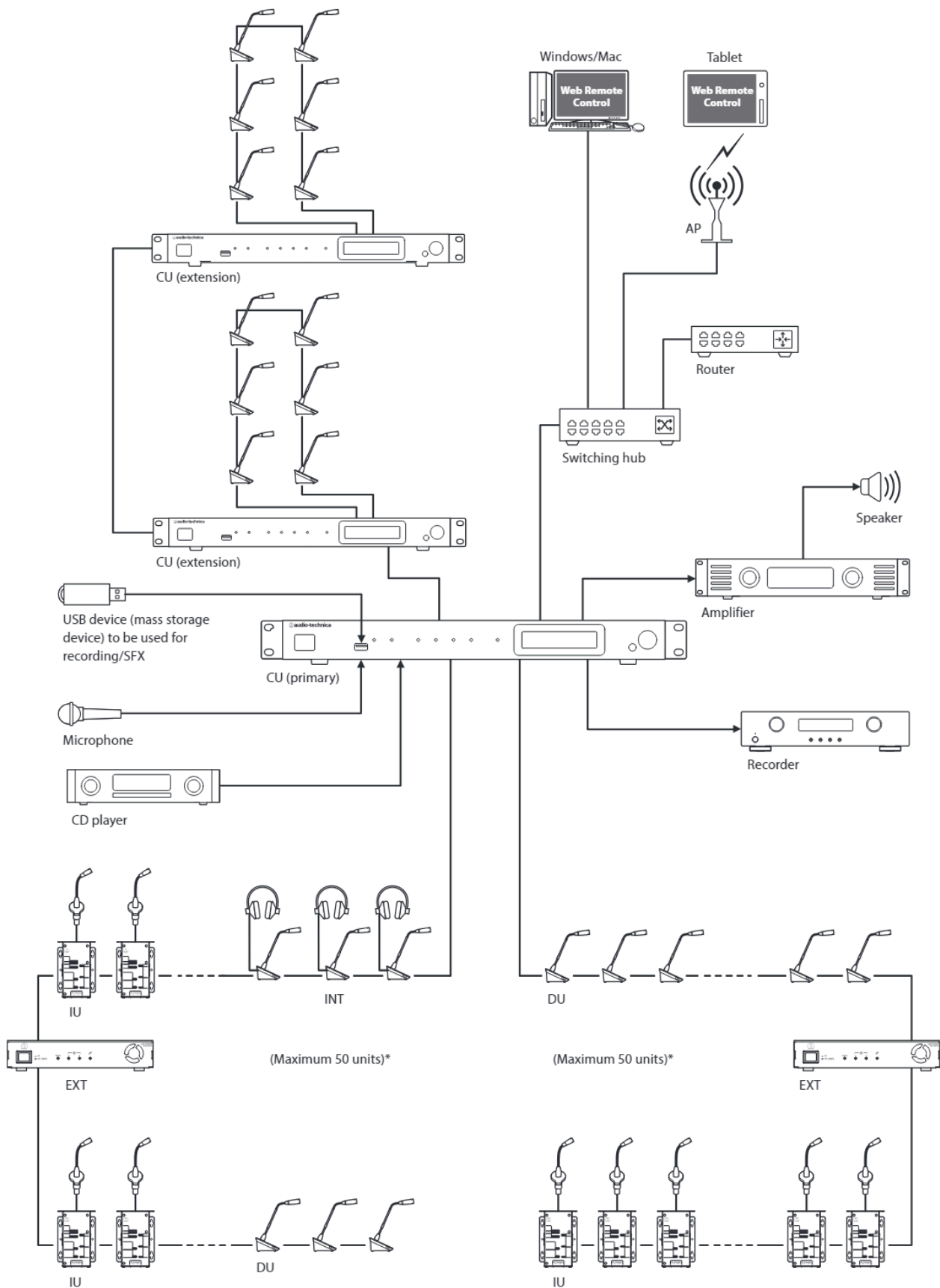

*The number of connectable units differs depending on the system configuration that you are using. For more details, refer to ▶ page 28.

Part Names and Functions

ATUC-50CU

Front panel

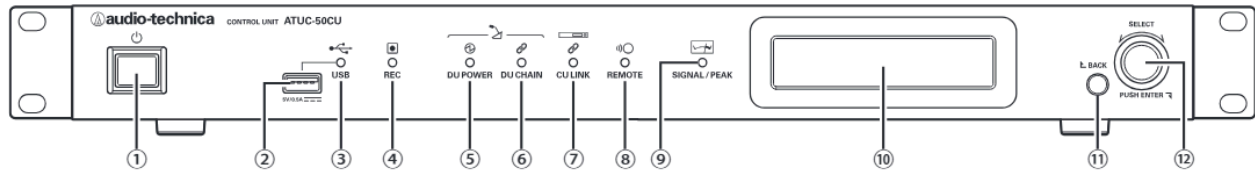

① Power switch

Turns the power of the CU on and off.

② USB terminal

The following operations can be performed by connecting a USB device (mass storage device) such as a USB flash drive or USB hard drive.

- Recording sound (▶ page 65)
- Playing buzzer and chime (▶ page 65)
- Importing/exporting preset data (▶ page 61)
- Upgrading the firmware (▶ page 46)

- NOTICE**
- Supports FAT16 and FAT32 file systems
 - Maximum storage capacity: 2TB
 - Maximum file size: 2GB
 - Does not support USB hubs.
 - Do not use extension cables.
 - Do not attempt to use USB devices (mass storage devices) that have been cracked, deformed or repaired using adhesive tape or the like.
 - Do not save or create any files or folders unnecessary for this system on the USB device (mass storage device); doing so may affect system operations.
 - The CU is not compatible with USB devices (mass storage device) with special functions such as a security function.

③ USB access indicator

Indicates the connection status of the USB device (mass storage device).

- In an access state: lit green

- NOTICE**
- Do not remove the USB device (mass storage device) while the indicator is lit green; doing so may destroy data.

④ REC (recording) indicator

Indicates the recording status.

- In a recording state: lit green
- In a recording-pause state: blinks green
- While not recording: remains off

- NOTICE**
- If you remove the USB device (mass storage device) while in a recording state or recording-pause state, the recorded file may not be written correctly. Do not remove the USB device (mass storage device) during recording.

⑤ DU POWER (DU power supply) indicator

- In a normal state: lit green
- In an abnormal state (such as when a voltage drop occurs in the 48V output system): blinks green
- In a DU/INT disconnected state: remains off

⑥ DU CHAIN indicator

- In a normal state: lit green
- In an abnormal state (such as when failing in communication with a DU): blinks green
- In a DU/INT disconnected state: remains off

⑦ CU LINK indicator

- In a CU Link state: lit green
- In an abnormal state (such as when failing in communication with a CU): blinks green
- In a CU Link cut-off state: remains off

⑧ Remote (remote control) indicator

- In a communication state: lit green
- In an abnormal state (such as when failing in external transmission retry): blinks green
- In a non-communication state: remains off

⑨ SIGNAL/PEAK indicator

Indicates the audio signal level as follows:

- 60dBFS or higher: lit green
- 20dBFS or higher: lit amber
- 2dBFS or higher: lit red

Adjust the audio signal level such that the indicator will not light red (▶ page 65).

⑩ CU display

⑪ BACK button

Returns to the previous or upper screen/item.

Press and hold this button to return to the HOME screen from any screen.

⑫ Jog dial/ENTER button

Rotate the jog dial to select the desired item and then press the ENTER button to confirm.

Rotating the jog dial also adjusts the setting values.

• Locking the operation buttons (Key Lock function)

Press the BACK button and ENTER button simultaneously for over 2 seconds to activate the Key lock function, and thus lock all front panel operations except for the Power switch.

• Unlocking the operation buttons

When the operation buttons are locked, press the BACK button and ENTER button simultaneously for over 2 seconds to unlock the operation buttons.

CU display and jog dial operations:

HOME screen

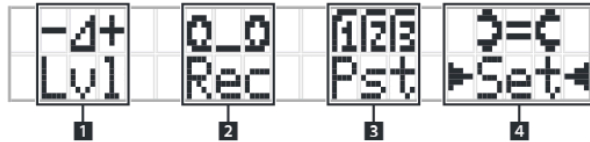

The item with ▶ ◀ is the currently selected item.

By rotating the jog dial, move ▶ ◀ to select the operation you want to perform and then press the ENTER button.

1 Master level adjustment (Lvl)

Master level
-50 -40 -30 -20 -12 -6 0 6 12 Peak (dBu)



- Rotate the jog dial to adjust the CU output level (OUTPUT 1).
- While pressing the ENTER button, rotate the jog dial to adjust the level in 10-step increments.
- Be sure that the Peak indicator does not light up while adjusting the level.

2 Recording operations (Rec)

R (Remaining recording time)/E (Elapsed recording time) display

-50 -40 -30 -20 -12 -6 0 6 12 Peak (dBu)



- Rotate the jog dial to select *Rec* (Start recording)/*Pau* (Pause)/*Stp* (Stop)/*R* or *E* (Recording time display) and then press the ENTER button to confirm.
- Select the time display on the top right side of the screen using the jog dial and then press the ENTER button to switch the display between *R* (Remaining recording time)/*E* (Elapsed recording time).
- To adjust the recording level, move ▶ ◀ to the recording level meter at the top left of the screen to display *Rec Lvl* and then press the ENTER button to enter recording level adjustment mode. Rotate the dial to adjust the recording level being sure that the Peak indicator does not light up.
- While pressing the ENTER button, rotate the jog dial to adjust the level in 10-step increments.

3 Conference preparation (Pst)



- [1] *Recall Presets*: Rotate the jog dial to move ">" to the item you want to recall and then press the ENTER button to confirm.
- [2] *Conf. Setup*: Change or check the conference settings. Rotate the jog dial to move ">" to the item you want to change or check and then press the ENTER button to confirm.

Pst Menu Items:

Settings can also be configured via Web Remote. The item names in parentheses () are used for Web Remote.

[1] *Recall Presets*

[2] *Conf. Setup* (▶ page 52)

01 *Conference Mode* (Conference Mode)

02 *NOM* (Number of Open Mics)

03 *Auto Mic Off* (Auto Mic OFF)

04 *Override Mode* (Override Mode)

05 *Max Queue* (Maximum in Queue)

06 *MicON Trigger* (Mic ON Trigger / Mic ON Trigger for Priority)

07 *MicON Hold Time* (Mic ON Hold Time)

08 *Interrupt Option* (Interrupt Option)



• Items that can be configured from [2] *Conf. Setup* differ depending on the conference mode.

• For details on items, see "Menu items" (▶ pages 44 - 60).

4 Configuring settings (Set)

Rotate the jog dial to move ">" to the desired item or value and then press the ENTER button to confirm.

For details on setting items, see "Set Menu Items" (▶ page 22).

Rear panel

* The serial number label is located on the top panel.

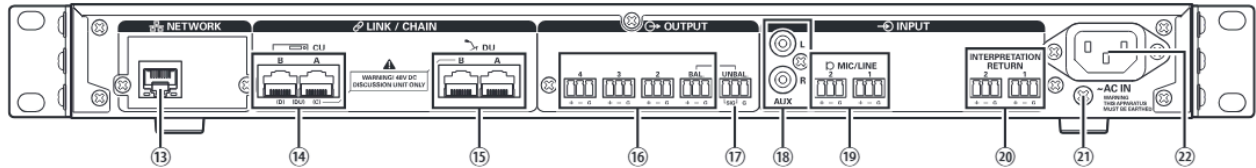

- NOTICE**
- Refer also to the instruction manuals supplied with the external devices.
 - Be careful NOT to connect the Ethernet cable from your network device to the CU LINK terminal or DU CHAIN terminal. This can cause damage to the connected device.

13 NETWORK terminal

- RJ-45
- Use for connecting to a local area network when controlling from an external device via the Web Remote Control or IP remote function (▶ page 38)

14 CU LINK A/B terminals, DU CHAIN C/D terminals

- RJ-45
- Use for cascading multiple CUs (▶ page 36). You can also configure these terminals as DU/IU/INT terminals (▶ page 27)

15 DU CHAIN A/B terminals

- RJ-45
- Use for connecting DUs/IUs/INTs. You can daisy-chain multiple DUs/IUs/INTs as well as ring multiple DUs/IUs/INTs using the A/B terminals



- By cascade-connecting multiple CUs, up to 300 DUs/IUs/INTs can be connected (with a maximum of 6 INTs). (▶ page 36).

16 Analog output (balanced) terminals: OUTPUT 1-4 (BAL)

- Euroblock
- Pin arrangement: “+” Hot/“–” Cold/“G” GND

17 Analog output (unbalanced) terminals: OUTPUT1 (UNBAL)

- Euroblock
- Pin arrangement: “SIG” Signal (2 systems)/“G” GND

18 Analog input (unbalanced) terminals: INPUT (AUX)

- RCA

19 Analog input (balanced) terminals: INPUT (MIC/LINE 1-2)

- Euroblock
- Pin arrangement: “+” Hot (supports phantom power)/“–” Cold (supports phantom power)/“G” GND
- The input type can be switched between MIC and LINE (▶ page 49)

20 Analog input (balanced) terminal: INPUT (INTERPRETATION RETURN 1-2)

- Euroblock
- Pin arrangement: “+” Hot/“–” Cold/“G” GND
- Inputs audio signals from simultaneous interpretation system

21 Ground screw

- Since the supplied AC power cord has a three-pronged plug, as long as your AC power wall outlet is grounded properly, the CU will also be grounded properly.

22 AC Inlet (AC IN)

- Connect the supplied AC power cord.

- NOTICE**
- Do not plug in the AC power cord until all other connections have been completed.
 - Be sure that the CU is securely grounded to a single ground point. Grounding to multiple ground points can cause ground loops, resulting in noise generation such as a humming noise.

ATUC-50DU

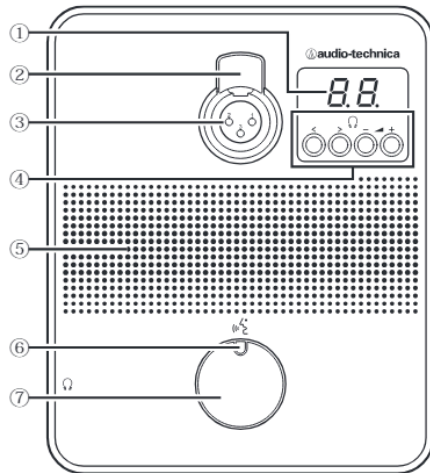

① Display

When changing monitor channel or adjusting the volume level, the currently set value is displayed.

② Microphone release lever

③ Microphone jack

Connect a microphone.

- A typical 3-pin XLR type microphone as well as the ATUC-M series microphone can be connected.

④ </> Monitor channel selection buttons

When operating the </> monitor channel selection buttons, the currently selected monitor channel is shown on the display ①.

FL: Monitors speech from the floor channel.

01-03: Monitors speech from groups 1 to 3. Speech interpreted by interpretation units is added to the speech from groups 1 to 3 when INTs are connected on the same system.

-/+ Headphone volume adjustment buttons

When operating the -/+ headphone adjustment buttons, the current volume level (0 to 20) is shown on the display ①.

⑤ Built-in speaker

Outputs conference audio.

⑥ (talk) LED

Displays DU talk status.

- While talking: lit red
- When requested to talk (in standby mode): blinks green
- When talk request is rejected: blinks green (quickly blinks 4 times)

• The LED colors can be changed (▶ page 53).

⑦ (talk) button

Press this button to send a request to talk. Press the button again to finish talking or cancel the request to talk. DUs designated as a priority DU can cut other DU speakers short and mute other DUs by pressing this button.

Operations when the (talk) button is pressed briefly:

Conference mode	Current state	Mic ON Trigger mode	
		Button	Voice
Free Talk	Talk OFF	Talk ON	- (Not acceptable)
	Requesting to talk	Cancel request	
	Talk ON	Talk OFF	
Request Talk	Talk OFF	Request to talk	
	Requesting to talk	Cancel request	
	Talk ON	Talk OFF	
Full Remote	-	- (External control only)	

• On priority DUs, operations of the priority DUs are same as in Free Talk Mode regardless of the conference mode.

Operations when the (talk) button is pressed and held:

Only for Priority DUs with [Can Cut/Mute] set to on

Current state	Mic ON Trigger mode			
	Button	Voice	Button/Voice	
			Cut mode	Mute mode
	Press the button for 2 seconds or less		Press and hold the button for over 2 seconds	
Talk OFF	Talk ON	- (Not acceptable)	Talk ON(*1)	Talk ON(*2)
Talk ON	Talk OFF		Talk ON stays active(*1)	Talk ON stays active(*2)

*1 All specified DUs will be in Talk OFF state.

*2 All specified DUs will be in mute state.

ATUC-50INT

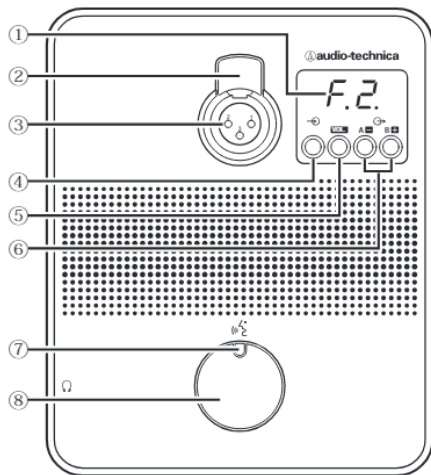

① Display

- Character on the left: Displays the current monitor channel.
 - F: Monitors speech from the floor channel (speech from all meeting participants).
 - 1: Monitors speech from language group 1.
- Digit on the right: Displays the language group (1 to 3) assigned to the INT output.
 - When adjusting the volume level, the set value is displayed.

② Microphone release lever

③ Microphone jack

- Connect a microphone.
- A typical 3-pin XLR type microphone as well as the ATUC-M series microphone can be connected.

④ Monitor channel selection button

- Switches the speech from the floor channel and the speech from language group 1 each time it is pressed.

⑤ **VOL** Headphone volume adjustment button

- When operating this button, the current volume level (0 to 20) is shown on the display ①. The volume is adjusted by operating the **+**/**-** buttons ⑥ while in this state.
- Operating this button while the volume level is displayed takes you back to the monitoring channel display.

⑥ **A / B Interpretation languages selection buttons (only available in bi-directional interpretation)**

- This function is only available when bi-directional interpretation has been selected. (Outgoing language A/Outgoing language B)
- Switches the location of the interpretation speech being output according to the interpretation pattern.

⑦ **Talk LED**

- Displays INT talk status.

⑧ **Talk button**

- Press this button to talk. Press the button again to finish talking.

Common to ATUC-50DU/INT

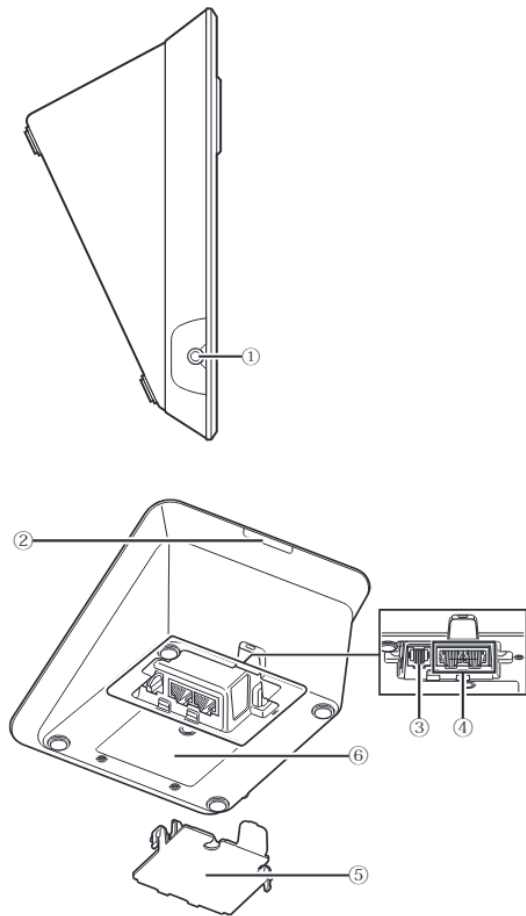

① Headphone jack

Speech from the selected monitor channel is output.

② Rear LED

The LED color can be set for each DU. It is useful when dividing DUs into groups by color. The LED color can be changed from Web Remote (▶ page 53).

NOTICE • Color settings cannot be done for INTs. The settings stay at their default.

③ Extension terminal

④ DU/CU connection terminals (▶ page 26)

⑤ Bottom cover

Covering the terminals protects them from dust and also prevents cables from becoming unplugged. Therefore, after connecting cables to each terminal, be sure to attach the bottom cover.

⑥ Serial number

ATUC-M

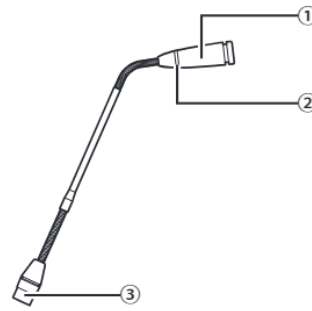

① Microphone

② Ring LED

Lights red when the microphone is activated.
Blinks red while waiting to talk.

③ Connector

ATUC-50IU

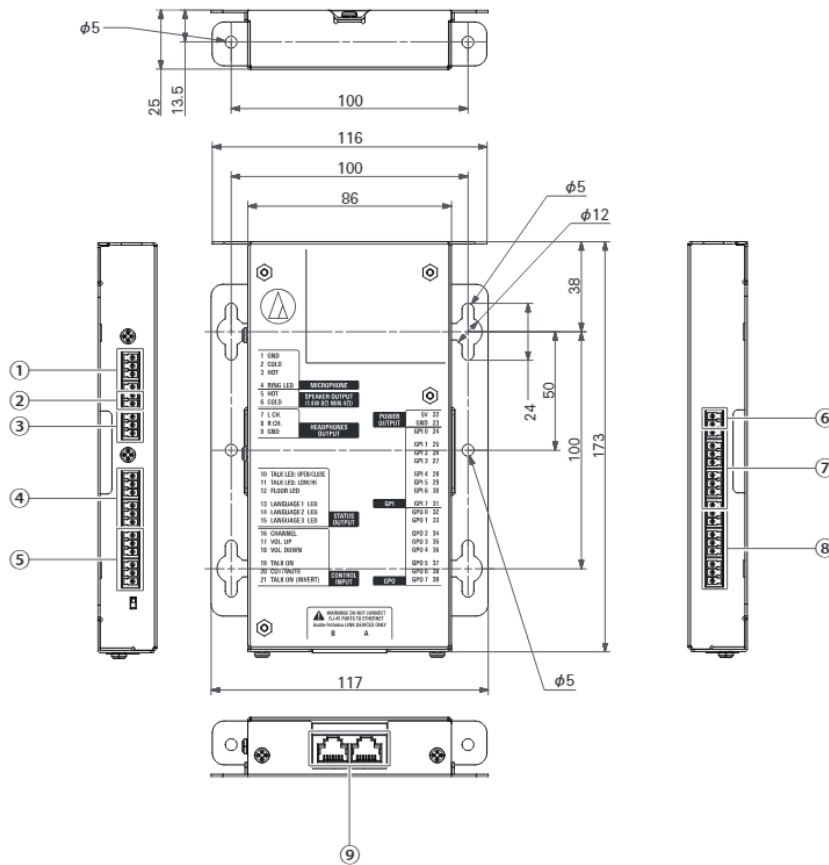

Because the IU is intended to be embedded in a table, etc., when it is used, the user interfaces, such as displays, operating terminals, and input/output terminals, can be customized according to their usage environment. Specifications for the interfaces are as follows.

① Microphone input terminal

Pin number	Signal name	Explanation	Terminal color
1	GND	Microphone input GND	Green
2	COLD	Microphone input balance	
3	HOT	Supplies a phantom power supply of +48 V (possible to toggle on/off)	
4	RING LED	For controlling ATUC-M LED	

② Speaker output terminal

Pin number	Signal name	Explanation	Terminal color
5	HOT	Speaker output	Green
6	COLD	1.4 W, 8 Ω (impedance over 4 Ω)	

• We recommend using a shielded wire for the speaker output terminal. The GND shield in this case is connected to the GND pin (9).

③ Headphone output terminal

Pin number	Signal name	Explanation	Terminal color
7	L ch	Headphone output 15 mW 32 Ω	Green
8	R ch		
9	GND	Headphone output GND	

④ Status output terminal

Pin number	Signal name	Explanation	Terminal color
10	TALK LED : OPEN/CLOSE	Talk ON: Close Talk OFF: Open Requesting to talk (waiting): blinks Talk request is rejected: blinks quickly	Black
11	TALK LED : LOW/HI	Terminal for AT8657/LED and U891RCx Talk ON: +5 V Talk OFF: 0 V On/off operations are synchronized with the open/close operations for the TALK LED pin (10)	
12	FLOOR LED	Selecting the floor channel on the monitor channel When selected: Close When unselected: Open	
13	LANGUAGE1 LED	Selecting group 1 on the monitor channel When selected: Close When unselected: Open	
14	LANGUAGE2 LED	Selecting group 2 on the monitor channel When selected: Close When unselected: Open	
15	LANGUAGE3 LED	Selecting group 3 on the monitor channel When selected: Close When unselected: Open	

⑤ Operation input terminal

Pin number	Signal name	Explanation	Terminal color
16	CHANNEL	Selecting the monitor's channel	Black
17	VOL. UP	Adjusting the headphones' volume	
18	VOL. DOWN		
19	TALK ON	Request to talk Yes: Close No: Open	
20	CUT/MUTE	Request to mute/cut microphone Yes: Close No: Open	
21	TALK ON (INVERT)	AT8657/LED dedicated terminal Request to talk Yes: +5 V No: 0 V The function of this pin is the same as that of the TALK ON pin (19) *When there is a TALK ON or TALK ON (INVERT) request to talk, the system handles them both as requests to talk.	

⑥ Power supply output terminal

Pin number	Signal name	Explanation	Terminal color
22	5 V	Power supply for LED is 5 V	Black
23	GND	Power supply GND	

⑦ General purpose input terminals (GPI)

Pin number	Signal name	Explanation	Terminal color
24	GPI0	General purpose input terminal 0	Black
25	GPI1	General purpose input terminal 1	
26	GPI2	General purpose input terminal 2	
27	GPI3	General purpose input terminal 3	
28	GPI4	General purpose input terminal 4	
29	GPI5	General purpose input terminal 5	
30	GPI6	General purpose input terminal 6	
31	GPI7	General purpose input terminal 7	

⑧ General purpose output terminals (GPO)

Pin number	Signal name	Explanation	Terminal color
32	GPO0	General purpose output terminal 0	Black
33	GPO1	General purpose output terminal 1	
34	GPO2	General purpose output terminal 2	
35	GPO3	General purpose output terminal 3	
36	GPO4	General purpose output terminal 4	
37	GPO5	General purpose output terminal 5	
38	GPO6	General purpose output terminal 6	
39	GPO7	General purpose output terminal 7	

- You can assign functions to the general purpose input/output terminals (GPI and GPO) on the web remote's settings screen. (▶ page 56)

⑨ Audio Technica LINK terminal

Connect the Audio Technica products and configure the system.

- NOTICE**
- Power is supplied to external devices from the 5 V pin (22); however this pin has a maximum rating of +5 VDC at 100 mA. When you use this, select a circuit or current limit (resistance value) so that the rating is not exceeded.
 - If this is used beyond its ratings, it may cause the product to malfunction, but even more so, it may cause fires or unforeseen accidents.

Example of a user interface connection

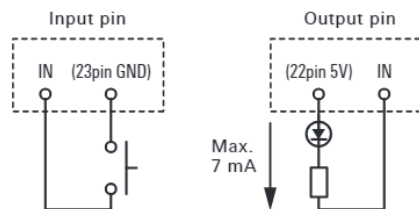
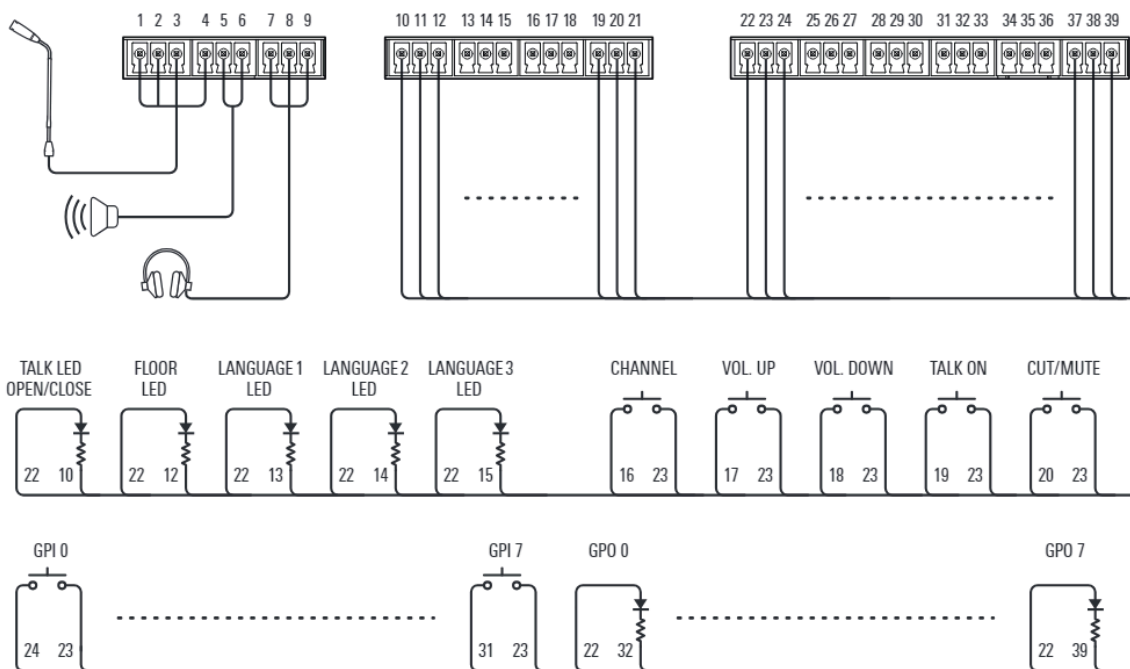

When using with the ATUC-M

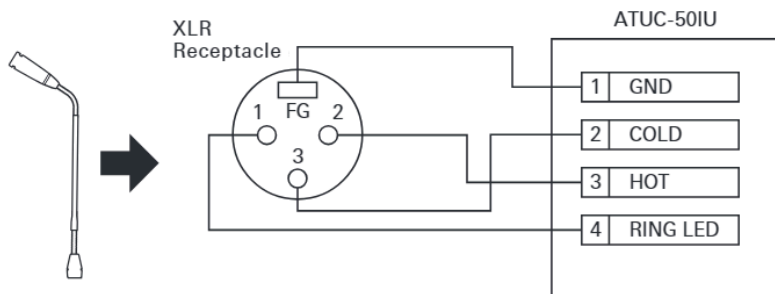

When using with the AT8657/LED

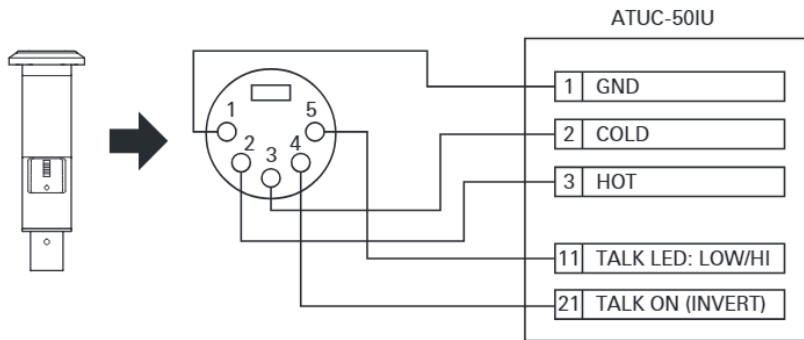

When using with the U891RCx

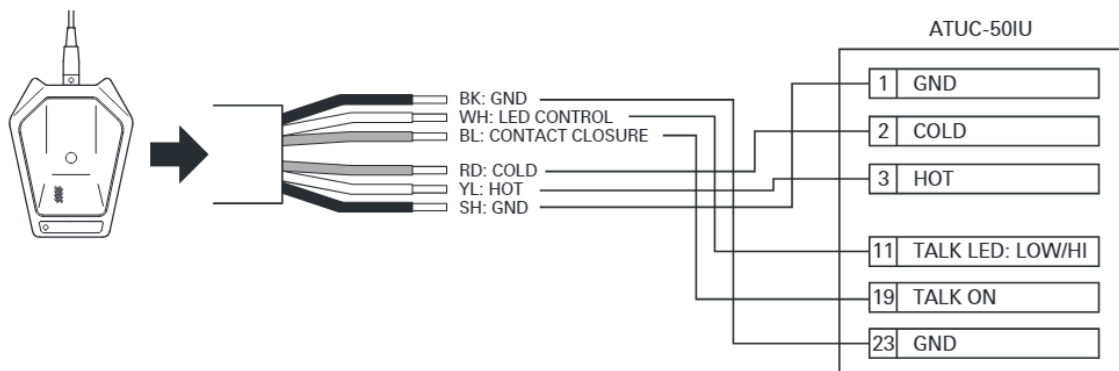

- Do the following settings for the U891RCx.
SW.FUNCTION: MOM. ON
CONTROL: LED Remote

Mounting an IU

- When securing in two directions
Align the IU with the edge of a table, etc., and then fasten it with screws.

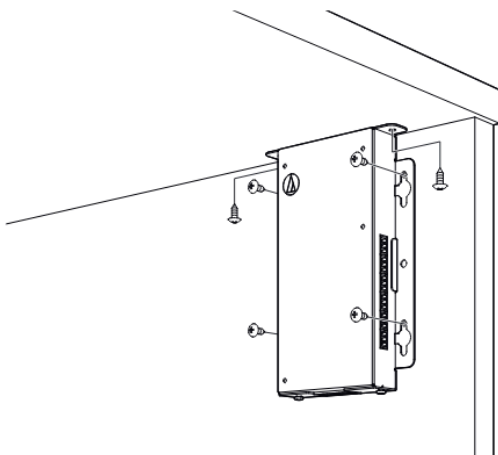

- When securing on only one side

Leave about 2 mm of the screws out when you fasten them to the table, and then hang the IU on them. Slide the IU downward, and then tighten the screws to secure the IU.

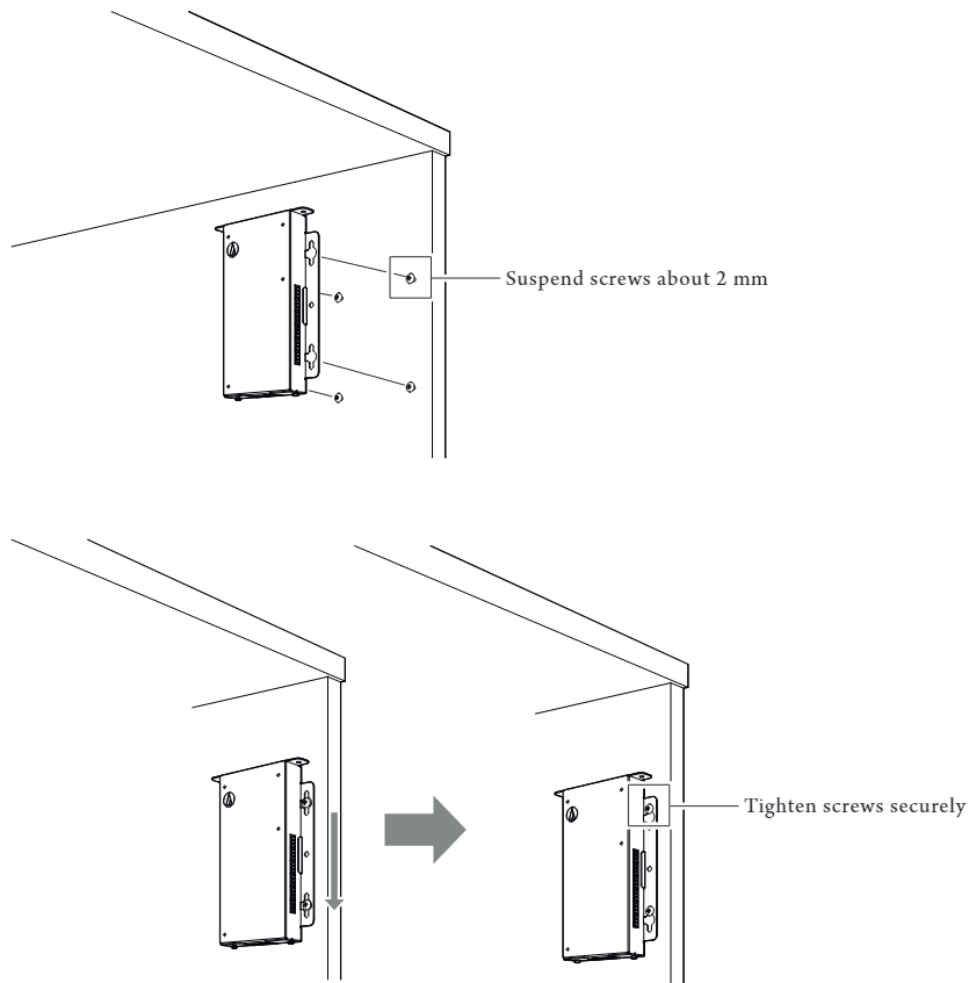

 • You can also mount the IU upside-down or sideways. When mounting, fasten at a minimum of two places with screws.

ATLK-EXT165

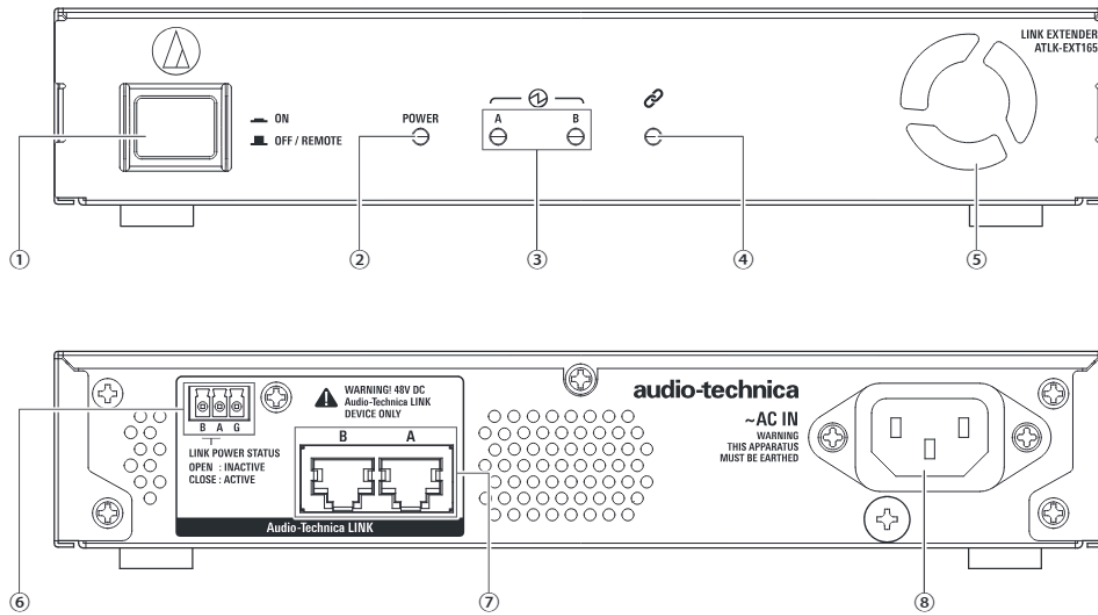

① Mode switch

Remote mode	This mode allows the CU to automatically start the unit.
Standalone mode	This mode allows you to operate the EXT by itself.

We recommend using the remote mode if you are using the EXT.

Use the following procedure to turn the EXT's mode switch on and off manually in standalone mode. If you change the order of operations, the DU that is connected may not be recognized correctly.

- To turn on the power
Turn on CU power → Turn on mode switch of EXT
- To turn off the power
Turn off mode switch of EXT → Turn off CU power

② Power indicator

③ Audio Technica LINK Device indicator

Indicates the connection status of devices that support Audio Technica LINK.

- Connected: Lit
- Unconnected: Unlit

④ Data indicator

- Establishing link (data not transmitted): Lit
- Transmitting data: Blinking
- No link: Unlit

⑤ Cooling fan

⑥ Audio Technica LINK POWER STATUS output terminal

Open: Power inactive
Close: Power active

⑦ Audio-Technica LINK A/B terminals

- RJ-45
- Use to connect the devices that support Audio-Technica LINK.

⑧ AC inlet (AC IN)

Connect the supplied AC power cord.

Changing settings from ATUC-50CU

You can change CU settings by selecting "Set" on the HOME screen of the CU display. Changeable items are as follows.

For more detailed settings, or for individual DU/IU/INT settings, use Web Remote.

 After changing the network setting item(s), restart the CU to enable the setting values.

Set Menu Items

[1] System Setting (page 44)	
01 Device Name	ATUC-50CU
02 Link Port Set	CU A/B, DU C/D
03 CU Link Mode	Primary, Extension Pass Thru, Extension Last Unit
04 CU Error Notice	On, Off
05 IP Setting	
01 IP Config Mode	Auto, Static
02 IP Address	0.0.0.0 - 255.255.255.255
03 Subnet Mask	0.0.0.0 - 255.255.255.255
04 Gateway Address	0.0.0.0 - 255.255.255.255
06 Allow Discovery	On, Off
07 IP Ctrl Setting	
01 IP Ctrl Port No	00001 - 65535
02 IP Ctrl Ntfy	On, Off
03 Audio Level Ntfy	On, Off
04 M-cast Adrs	0.0.0.0 - 255.255.255.255
05 M-cast Port No	00001 - 65535
08 Auto Mode Change	
01 Auto Mode Change	On, Off
02 Hold Time(Err)	20, 30, 40 seconds
09 NTP Setting	
01 NTP	On, Off
02 NTP Adrs	0.0.0.0 - 255.255.255.255
03 NTP Port	00001 - 65535
04 Time Zone	UTC -12:00 to +14:00
05 DST	On, Off
06 DST Start Date	1/1 - 12/31
07 DST Start Time	0:00 - 23:00
08 DST End Date	1/1 - 12/31
09 DST End Time	0:00 - 23:00
10 Login Password	
01 Admin.Pwd.Login	On, Off
02 Admin.Password	Displays password
03 Opr.Pwd.Login	On, Off
04 Opr.Password	Displays password
11 Reset All Dflt.	
[2] System Info (page 61)	Displays current settings
01 Name	
02 Serial Number	
03 FW Version	
04 IP Config Mode	
05 IP Address	
06 Subnet Mask	
07 Gateway Address	
08 Mac Address	
09 Allow Discovery	
10 IP Ctrl Port No	
11 IP Ctrl Ntfy	
12 Audio Level Ntfy	
13 M-cast Adrs	
14 M-cast Port No	
15 NTP	
16 NTP Adrs	
17 NTP Port	

18 Time Zone	
19 CU Link Status	
20 CU Link Mode	
21 No.ofExtensionCU	
22 Total No.of DU	
23 Total No.of IU	
24 Total No.of INT	

[3] Audio Setting (page 49)	
01 MIC/LINE Input 1	
01 Input Type	Mic, Line +4dBu, Line 0dBV
02 Input Gain	-60dB to -16dB
03 Level	-∞, -120 to +10dB
04 Phantom Power	On, Off
05 Mix to Floor	On, Off
02 MIC/LINE Input 2	
01 Input Type	Mic, Line +4dBu, Line 0dBV
02 Input Gain	-60dB to -16dB
03 Level	-∞, -120 to +10dB
04 Phantom Power	On, Off
05 Mix to Floor	On, Off
03 AUX Input	
01 Level	-∞, -120 to +10dB
02 Mix to Floor	On, Off
04 DU SP Output Lvl	0 - 20
05 DU Floor Lock	On, Off
06 VoiceDetectSens	-5, -4, -3, -2, -1, 0, 1, 2, 3, 4, 5
07 Auto to Mic2 In	On, Off

[4] Recorder Setting (page 60)	
01 Rec Format	WAV, MP3
02 RecordingQuality	64, 128, 192, 256, 320kbps
03 No.of Rec CH	1 to 4 (WAV), 1 to 2 (MP3)
04 Rec Source CH1	Floor, Group 0, Group 1, Group 2, Group 3, Language 1, Language 2, Language 3, Remote Lang. 1, Remote Lang. 2, Mic/Line 1, Mic/Line 2, Mic/Line 1&2 Mix
05 Rec Source CH2	Floor, Group 0, Group 1, Group 2, Group 3, Language 1, Language 2, Language 3, Remote Lang. 1, Remote Lang. 2, Mic/Line 1, Mic/Line 2, Mic/Line 1&2 Mix
06 Rec Source CH3	Floor, Group 0, Group 1, Group 2, Group 3, Language 1, Language 2, Language 3, Remote Lang. 1, Remote Lang. 2, Mic/Line 1, Mic/Line 2, Mic/Line 1&2 Mix
07 Rec Source CH4	Floor, Group 0, Group 1, Group 2, Group 3, Language 1, Language 2, Language 3, Remote Lang. 1, Remote Lang. 2, Mic/Line 1, Mic/Line 2, Mic/Line 1&2 Mix
08 Auto Track	Off, 15, 30 min, 1, 2 hour
09 Filename Prefix	Displays filename prefix

[5] Conference Mode (page 52)	
01 Conference Mode	Free Talk, Request Talk, Full Remote
02 NOM	1 to 10
03 Auto Mic Off	5 to 60sec ,Off
04 Override Mode	No Override, FIFO, LIFO (depending on Conference Mode)
05 Max Queue	0-150

06 MicON Trigger	All Button, All Voice, Individual
07 MicON Hold Time	1.0 to 10.0 seconds
08 Interrupt Option	Cut, Mute
[6] Logging (▶ page 61)	
01 Logging	On, Off
02 Destination	Internal, USB
[7] Presets (▶ page 61)	
01 Recall Presets	Recalls presets
02 Save Presets	Saves presets
03 Import Presets	Imports presets
04 Export Presets	Exports presets
05 Boot Up Preset	Calls presets at boot up

Entering letters

For example, when entering letters from [4] *Recorder Setting* → 09 *Filename Prefix*, follow the procedure below.

1 Rotate the jog dial to select a letter.

You can use the following characters.

(1) *Password*

A to Z, a to z, 1 to 9, 0

(2) *Device Name*

A to Z, a to z, 1 to 9, 0, ! # \$ ' () * + , - . : ; < = > ? @ ` , (space)

(3) *Filename Prefix*

A to Z, a to z, 1 to 9, 0, ! # \$ ' () + , - . : ; = ? @ ` , (space)

2 Press the ENTER button to enter the selected letter.

The cursor moves to the right.

3 Repeat steps 1 and 2 to enter desired text.

To delete characters you have just entered, follow the procedure below.

- **To move the cursor to the character you want to edit:**

(1) While pressing and holding the BACK button, rotate the jog dial to move the cursor.

(2) Release the BACK button.

- **To delete characters you have just entered:**

(1) Move the cursor to the character you want to delete.

(2) While pressing and holding the BACK button, press the ENTER button.

The character at the current cursor position will be deleted.



- When the cursor flashes in “_” state at the end of the text, the character just before the cursor will be deleted.

- **To change characters you have just entered:**

(1) Move the cursor to the character you want to edit.

(2) Rotate the jog dial to select the desired character.

- **To finish editing:**

(1) When the cursor is in “■” blinking state, press the ENTER button.

When editing ends, the cursor will move to the end of the text and “_” will blink.

4 To enter the text, when the cursor is in the “_” blinking state, press the ENTER button.

Displays *Completed!* followed by the file name.

Overview of the Interpretation Unit (ATUC-50INT)

- Up to 6 interpretation units can be connected.
- The maximum number of DU/IU/INT connections is 300 (when three CUs are linked).
- INTs can only be connected to the primary CU. They cannot be connected to extension CUs.

Digital Conference System ATUC-50 with the additional Interpretation Unit ATUC-50INT enables the following three types, (1) to (3), of interpretation.

This section explains a brief overview of operations assuming that you have set the interpretation languages as in the following table.

Language Name	Audio Group 1	English
	Audio Group 2	Japanese
	Audio Group 3	French

(1) Interpretation using two languages (2 Languages)

- While in the 2 Languages interpretation mode, you can select from three interpretation patterns (see table below).
- For instance, when the interpretation pattern “English → Japanese” is set, “F” appears as the character on the left in the display ①, and “2” appears as the digit on the right. At this time, the speech from the floor channel is heard through the monitor channel. Additionally, interpreted speech that is input from the microphone of the INT is output to Audio Group 2 (the Japanese group).
- When the bi-directional interpretation pattern is selected, the interpretation system is established with just this INT1. Pressing the interpretation languages selection button ⑥ switches the interpretation patterns between “Japanese → English (Outgoing language A)” and “English → Japanese (Outgoing language B)”, simultaneously switch the interpreted speech being output. Whichever interpretation pattern you selected, “Japanese → English (Outgoing language A)” or “English → Japanese (Outgoing language B)”, it is not saved. When the system is started, the interpretation pattern is “Japanese → English (Outgoing language A)”.

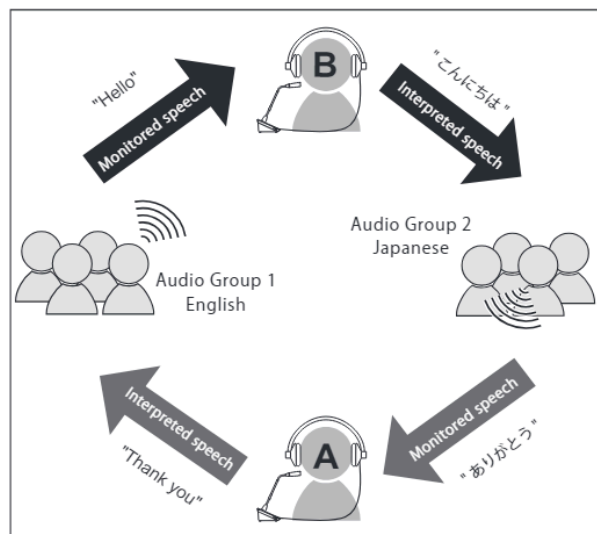

Interpretation pattern	Interpreter	Monitored speech	Character on the left	Output destination group		Digit on the right
				Outgoing language A	Outgoing language B	
English ↔ Japanese	A + B	Floor*	F*	English	Japanese	1
				Japanese	English	2
English → Japanese	Japanese			2		
Japanese → English	English			1		

* Interpreters can do a switch operation to monitor the audio of language group 1 (key language)

(2) Interpretation using three languages (3 Languages)

- While in the 3 Languages interpretation mode, you can select from nine interpretation patterns (see table below).
- Although there are three ways to do combinations within 2 Languages, the basic operations are the same as those for 2 Languages interpretation.

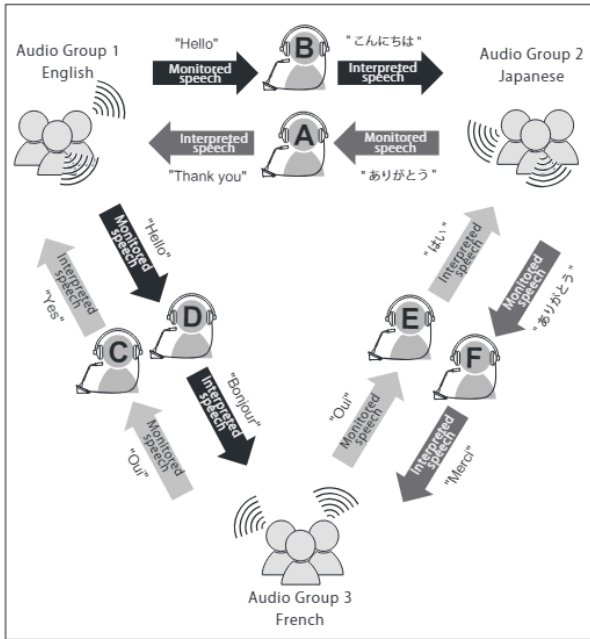

Interpretation pattern	Interpreter	Monitored speech	Character on the left	Output destination group		Digit on the right
				Outgoing language A	Outgoing language B	
English ↔ Japanese	A + B	Floor*	F*	English	Japanese	1
				Japanese	English	2
English ↔ French	C + D	Floor*	F*	English	French	3
				French	English	1
Japanese ↔ French	E + F	Floor*	F*	Japanese	French	3
				French	Japanese	2
English → Japanese	B	Floor*	F*	Japanese		2
Japanese → English	A	Floor*	F*	English		1
English → French	D	Floor*	F*	French		3
French → English	C	Floor*	F*	English		1
Japanese → French	F	Floor*	F*	French		3
French → Japanese	E	Floor*	F*	Japanese		2

* Interpreters can do a switch operation to monitor the audio of language group 1 (key language)

- Out of the three languages, the language of Audio Group 1 is used as the key language (in this case it is English), and relay interpretation is possible. (diagram below)
- When interpreting from French to Japanese, for example, Interpreter C first interprets "French → English". Interpreter B switches the monitor channel to the key language "1", listens to the English interpretation from interpreter C, and then interprets "English → Japanese".
- Other than that, the basic operations are the same as those for 2 languages.

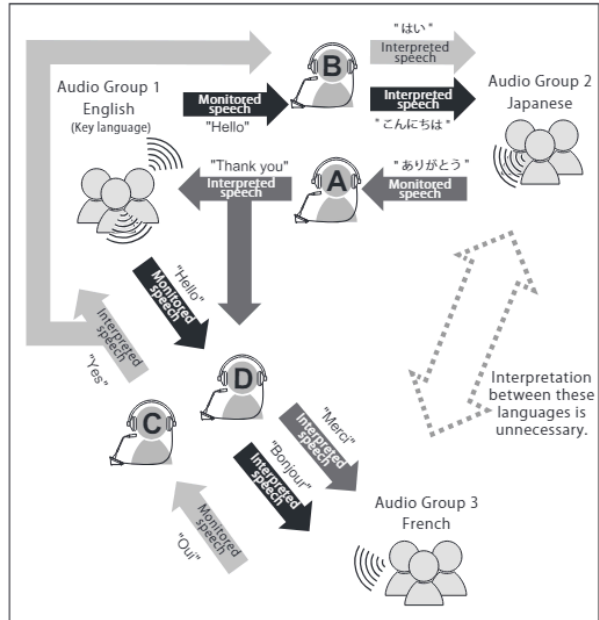

Interpretation pattern	Interpreter	Monitored speech	Character on the left	Output destination group		Digit on the right
				Outgoing language A	Outgoing language B	
English ↔ Japanese	A + B	Floor/English	F/1	English	Japanese	1
				(switched by interpreter)	Japanese	English
English ↔ French	C + D	Floor/English	F/1	English	French	3
				(switched by interpreter)	French	English
English → Japanese	B	English	1	Japanese		2
Japanese → English	A	Floor	F	English		1
English → French	D	English	1	French		3
French → English	C	Floor	F	English		1

System Connections and Configuration

Connecting devices

- NOTICE**
- Do not plug in the supplied AC power cord until all other connections have been completed.
 - Insert the plugs all the way in. Loose connections may cause malfunctions or noise.
 - Check the plug orientations.
 - Refer also to the instruction manuals supplied with the external devices.
 - Although connecting the CUs, DUs, and INTs are described here, because basic IU connections are the same as those for DUs, refer to connecting the DUs when connecting IUs. However, refer to the "Relationship of the LAN cable length, number of units connected and number of EXTs required" table on (page 29, 33) regarding the number of IUs that are connected.

Entire system connection diagram (1)

Refer also to the entire system connection diagram (2) (page 38)

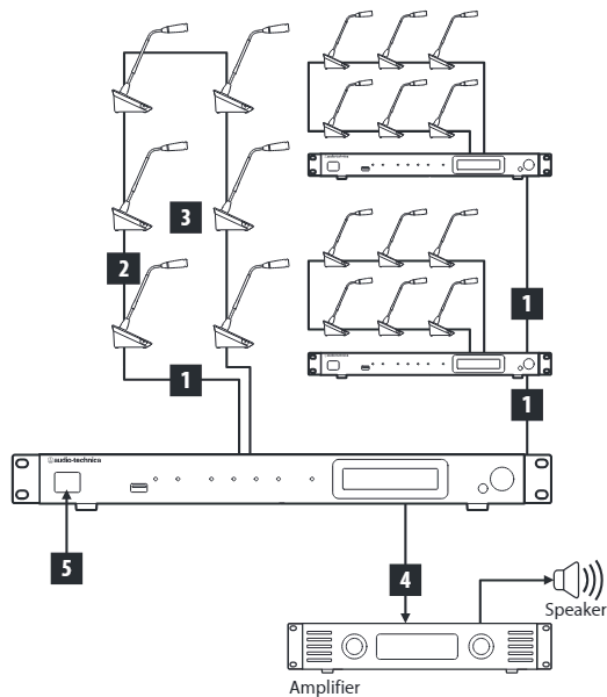

- NOTICE**
- Use straight cables. (Shielded cables with conductor size of 24AWG or higher in diameter are recommended.)
 - Using flat type cables or unshielded cables may cause noise and affect other devices.
 - Be sure to establish a ground connection.

When securing a DU/INT to a desk or table, use the screw holes (3 holes) on the bottom side of the DU/INT (screw: M3, P=0.5, within 6mm from the bottom side to the tip of the screw).

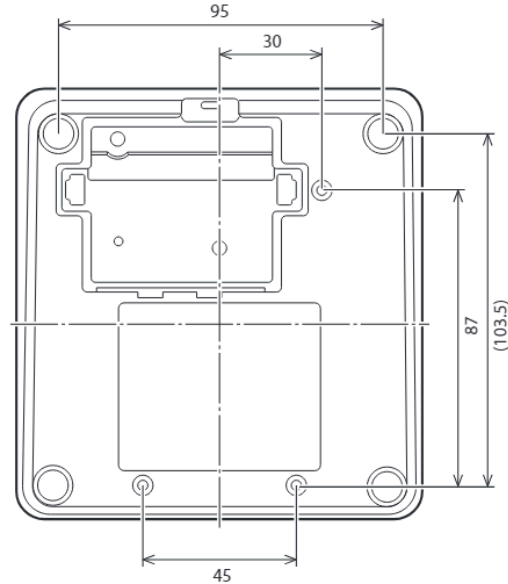

1 Connecting the DUs/INTs to the CU

1 Place the CU(s) and DUs/INTs.

- NOTICE**
- Place the units on a flat surface or install in a rack. Dropping a unit may cause damage to the unit and/or personal injury.
 - When installing the CU in a rack, read the precautions in advance (page 5).

2 Connect the DU/INT(s) to the DU CHAIN A/B terminal(s).

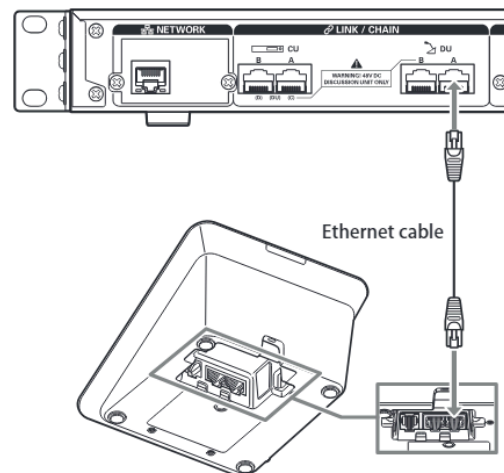

- Remove the DU/INT bottom cover to connect the Ethernet cables. When removing the bottom cover, pinch together the latches on both sides.
- On the DU/INT, the Ethernet cable may be connected to the left or right DU/CU connection terminal because the DU/INT does not distinguish between DU and CU connection terminals.

2 Connecting the DUs/INTs together

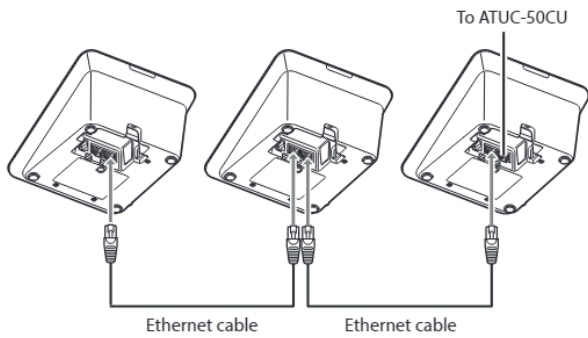

1 Connect the DUs/INTs according to the installation environment and operation method.

Daisy-chain connection:

Connect the DUs/INTs in a series to the DU CHAIN A/B (C/D) terminals. Compared to ring connection, daisy-chain connection enables the DUs/INTs to be placed even farther from the CU.

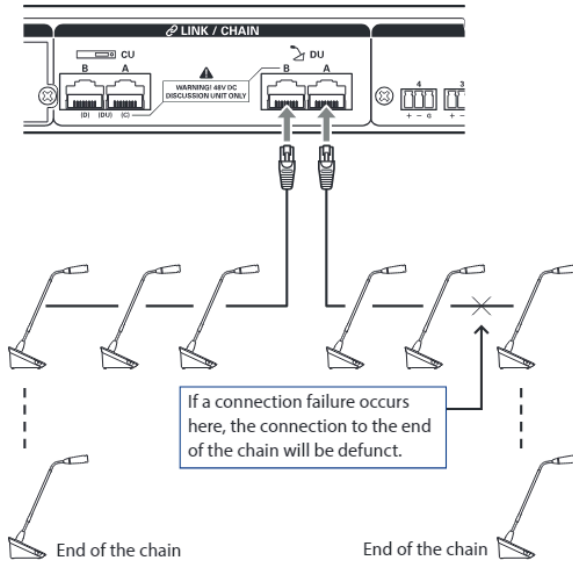

Ring connection:

Connect as many DUs/INTs as necessary to each of the DU CHAIN A/B terminals and then connect together the 2 DUs/INTs on both ends of the chain so as to form a ring. Even if a connection failure occurs somewhere in the ring, since the connection is recognized as 2 daisy-chains using the DU CHAIN A/B terminals, the influence of the failure can be minimized and you can carry on conference control.

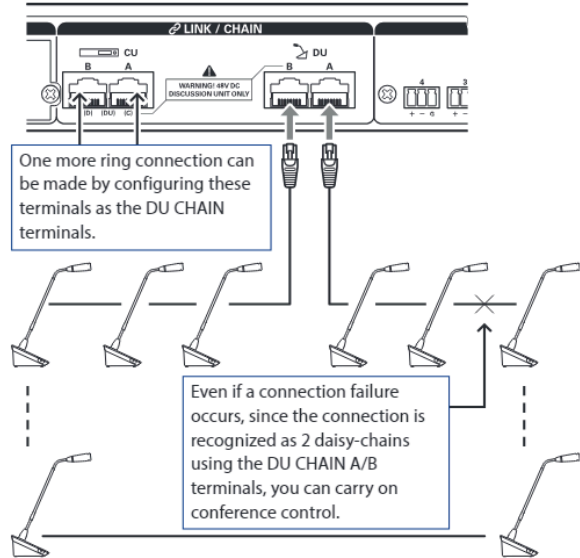

- Combining different connection types is also possible, such as a ring connection using the DU CHAIN A/B terminals and daisy-chain connections using the DU CHAIN C/D terminals.

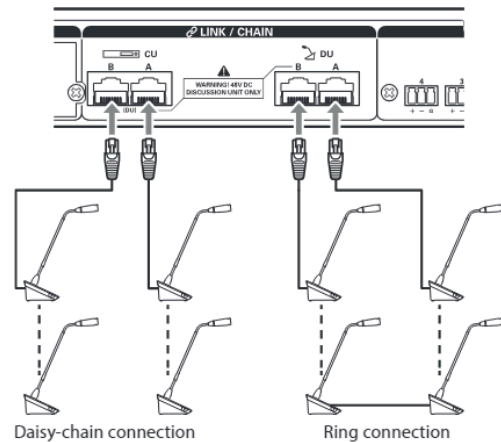

2 Expand the system with EXT.

By adding EXT to the system, you can increase the number of DU/INT/IU connections and extend the distance of the total extension length of the connecting cable (LAN cable).

For instance, you can connect a total of 100 DUs/INTs/IUs, 50 units on either terminal, by connecting an EXT near the B terminal when using a daisy chain connection on the DU CHAIN A/B terminals.

Maximum number of connections for each terminal/each CU in Standalone mode

	Maximum number of terminal connections in a DU CHAIN				
	A	B	C	D	Total
Daisy Chain	50	50	50	50	100*
Ring	50		50		100

* The maximum number of units that can be connected is up to 100 units to each terminal on the DU CHAIN by using the EXT.

* IUs consume more power than DUs, so the number of units shown in the table cannot be connected. If you connect that many, it may damage the CUs or the EXTs.

Refer to the "Relationship of the LAN cable length, number of units connected and number of EXTs required" tables on (▶ page 29, 33) regarding the number of IUs that can be connected.

Maximum number of connections for each terminal/each CU when using 3 CU links

	ATUC-50CU Primary			ATUC-50CU Extension *max 2pcs				System Total
	Maximum number of terminal connections in a DU CHAIN			Maximum number of terminal connections in a DU CHAIN				
	A	B	Total	A	B	Total	CU x 2 Total	
Daisy Chain	50	50	100	50	50	100	200	300
Ring	50		50	50		50	100	150

NOTICE • Up to 6 INTs can be connected to the primary CU.

Daisy-chain connection

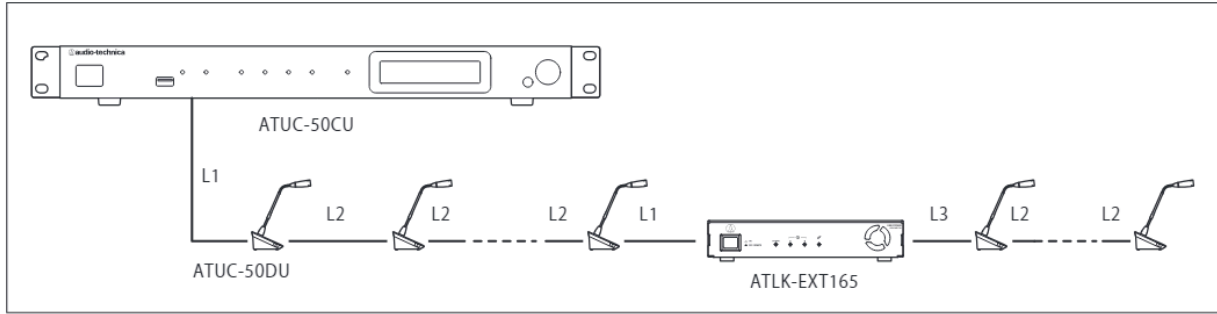

- NOTICE**
- For a CU-DU-DU-...DU-EXT connection, the distance between the [DU-EXT] is L1.
 - When it is EXT-DU-...-DU-DU-, the distance for [EXT-DU] is L3.

Relationship of the LAN cable length, number of units connected and number of EXTs required: Daisy chain connection

Length of cables			1-port daisy-chain connection (using DUs)		1-port daisy-chain connection (using IUs)	
CU-DU	DU-DU	EXT-DU	Number of DUs connected	Number of EXTs needed	Number of IUs connected	Number of EXTs needed
L1	L2	L3				
10 m	1.5 m	10 m	1 to 45 units	0 units	1 to 30 units	0 units
			46 to 50 units	1 unit	31 to 45 units	1 unit
50 m	1.5 m	10 m	1 to 36 units	0 units	1 to 24 units	0 units
			37 to 50 units	1 unit	25 to 39 units	1 unit
100 m	1.5 m	10 m	1 to 24 units	0 units	1 to 16 units	0 units
			25 to 50 units	1 unit	17 to 33 units	1 unit
10 m	2.0 m	10 m	1 to 29 units	0 units	1 to 27 units	0 units
			44 to 50 units	1 unit	28 to 43 units	1 unit
50 m	2.0 m	10 m	1 to 34 units	0 units	1 to 23 units	0 units
			35 to 50 units	1 unit	24 to 37 units	1 unit
100 m	2.0 m	10 m	1 to 24 units	0 units	1 to 16 units	0 units
			25 to 50 units	1 unit	17 to 33 units	1 unit
10 m	5.0 m	10 m	1 to 33 units	0 units	1 to 25 units	0 units
			34 to 50 units	1 unit	26 to 39 units	1 unit
50 m	5.0 m	10 m	1 to 27 units	0 units	1 to 20 units	0 units
			28 to 50 units	1 unit	21 to 34 units	1 unit
100 m	5.0 m	10 m	1 to 20 units	0 units	1 to 14 units	0 units
			21 to 48 units	1 unit	15 to 30 units	1 unit

Length of cables			2-port daisy-chain connection (using DUs)			2-port daisy-chain connection (using IUs)		
CU-DU	DU-DU	EXT-DU	Number of DUs connected	Maximum number of units connected	Number of EXTs needed	Number of IUs connected	Maximum number of units connected	Number of EXTs needed
L1	L2	L3						
10 m	1.5 m	10 m	1 to 25 × 2 units	(total 50 units)	0 units	1 to 16 × 2 units	(total 32 units)	0 units
			26 to 50 × 2 units	(total 100 units)	2 units	17 to 39 × 2 units	(total 78 units)	2 units
50 m	1.5 m	10 m	1 to 23 × 2 units	(total 46 units)	0 units	1 to 15 × 2 units	(total 30 units)	0 units
			24 to 50 × 2 units	(total 100 units)	2 units	16 to 37 × 2 units	(total 74 units)	2 units
100 m	1.5 m	10 m	1 to 20 × 2 units	(total 40 units)	0 units	1 to 13 × 2 units	(total 26 units)	0 units
			21 to 50 × 2 units	(total 100 units)	2 units	14 to 35 × 2 units	(total 70 units)	2 units
10 m	2.0 m	10 m	1 to 25 × 2 units	(total 50 units)	0 units	1 to 16 × 2 units	(total 32 units)	0 units
			26 to 50 × 2 units	(total 100 units)	2 units	17 to 37 × 2 units	(total 74 units)	2 units
50 m	2.0 m	10 m	1 to 23 × 2 units	(total 46 units)	0 units	1 to 15 × 2 units	(total 30 units)	0 units
			24 to 50 × 2 units	(total 100 units)	2 units	16 to 36 × 2 units	(total 72 units)	2 units
100 m	2.0 m	10 m	1 to 20 × 2 units	(total 40 units)	0 units	1 to 12 × 2 units	(total 24 units)	0 units
			21 to 50 × 2 units	(total 100 units)	2 units	13 to 34 × 2 units	(total 68 units)	2 units
10 m	5.0 m	10 m	1 to 24 × 2 units	(total 48 units)	0 units	1 to 16 × 2 units	(total 32 units)	0 units
			25 to 50 × 2 units	(total 100 units)	2 units	17 to 35 × 2 units	(total 70 units)	2 units
50 m	5.0 m	10 m	1 to 22 × 2 units	(total 44 units)	0 units	1 to 14 × 2 units	(total 28 units)	0 units
			23 to 50 × 2 units	(total 100 units)	2 units	15 to 33 × 2 units	(total 66 units)	2 units
100 m	5.0 m	10 m	1 to 19 × 2 units	(total 38 units)	0 units	1 to 12 × 2 units	(total 24 units)	0 units
			20 to 48 × 2 units	(total 96 units)	2 units	13 to 31 × 2 units	(total 62 units)	2 units

Length of cables			4-port daisy-chain connection (using DUs)			4-port daisy-chain connection (using IUs)		
CU-DU	DU-DU	EXT-DU	Number of DUs connected	Maximum number of units connected	Number of EXTs needed	Number of IUs connected	Maximum number of units connected	Number of EXTs needed
L1	L2	L3						
10 m	1.5 m	10 m	A/B: 1 to 15 × 2 units C/D: 1 to 10 × 2 units	(total 50 units)	A/B: 0 units C/D: 0 units	A/B: 1 to 10 × 2 units C/D: 1 to 6 × 2 units	(total 32 units)	A/B: 0 units C/D: 0 units
			A/B: 16 to 30 × 2 units C/D: 11 to 20 × 2 units	(total 100 units)	A/B: 2 units C/D: 2 units	A/B: 11 to 30 × 2 units C/D: 7 to 20 × 2 units	(total 100 units)	A/B: 2 units C/D: 2 units
50 m	1.5 m	10 m	A/B: 1 to 15 × 2 units C/D: 1 to 10 × 2 units	(total 50 units)	A/B: 0 units C/D: 0 units	A/B: 1 to 9 × 2 units C/D: 1 to 6 × 2 units	(total 30 units)	A/B: 0 units C/D: 0 units
			A/B: 16 to 30 × 2 units C/D: 11 to 20 × 2 units	(total 100 units)	A/B: 2 units C/D: 2 units	A/B: 10 to 30 × 2 units C/D: 7 to 20 × 2 units	(total 100 units)	A/B: 2 units C/D: 2 units
100 m	1.5 m	10 m	A/B: 1 to 14 × 2 units C/D: 1 to 10 × 2 units	(total 48 units)	A/B: 0 units C/D: 0 units	A/B: 1 to 8 × 2 units C/D: 1 to 6 × 2 units	(total 28 units)	A/B: 0 units C/D: 0 units
			A/B: 15 to 30 × 2 units C/D: 11 to 20 × 2 units	(total 100 units)	A/B: 2 units C/D: 2 units	A/B: 9 to 30 × 2 units C/D: 7 to 20 × 2 units	(total 100 units)	A/B: 2 units C/D: 2 units
10 m	2.0 m	10 m	A/B: 1 to 15 × 2 units C/D: 1 to 10 × 2 units	(total 50 units)	A/B: 0 units C/D: 0 units	A/B: 1 to 10 × 2 units C/D: 1 to 6 × 2 units	(total 32 units)	A/B: 0 units C/D: 0 units
			A/B: 16 to 30 × 2 units C/D: 11 to 20 × 2 units	(total 100 units)	A/B: 2 units C/D: 2 units	A/B: 11 to 30 × 2 units C/D: 7 to 20 × 2 units	(total 100 units)	A/B: 2 units C/D: 2 units
50 m	2.0 m	10 m	A/B: 1 to 15 × 2 units C/D: 1 to 10 × 2 units	(total 50 units)	A/B: 0 units C/D: 0 units	A/B: 1 to 9 × 2 units C/D: 1 to 6 × 2 units	(total 30 units)	A/B: 0 units C/D: 0 units
			A/B: 16 to 30 × 2 units C/D: 11 to 20 × 2 units	(total 100 units)	A/B: 2 units C/D: 2 units	A/B: 10 to 30 × 2 units C/D: 7 to 20 × 2 units	(total 100 units)	A/B: 2 units C/D: 2 units
100 m	2.0 m	10 m	A/B: 1 to 14 × 2 units C/D: 1 to 10 × 2 units	(total 48 units)	A/B: 0 units C/D: 0 units	A/B: 1 to 8 × 2 units C/D: 1 to 6 × 2 units	(total 28 units)	A/B: 0 units C/D: 0 units
			A/B: 15 to 30 × 2 units C/D: 11 to 20 × 2 units	(total 100 units)	A/B: 2 units C/D: 2 units	A/B: 9 to 30 × 2 units C/D: 7 to 20 × 2 units	(total 100 units)	A/B: 2 units C/D: 2 units

Length of cables			4-port daisy-chain connection (using DUs)			4-port daisy-chain connection (using IUs)		
CU-DU	DU-DU	EXT-DU	Number of DUs connected	Maximum number of units connected	Number of EXTs needed	Number of IUs connected	Maximum number of units connected	Number of EXTs needed
L1	L2	L3						
10 m	5.0 m	10 m	A/B: 1 to 15 × 2 units C/D: 1 to 10 × 2 units	(total 50 units)	A/B: 0 units C/D: 0 units	A/B: 1 to 10 × 2 units C/D: 1 to 6 × 2 units	(total 32 units)	A/B: 0 units C/D: 0 units
			A/B: 16 to 30 × 2 units C/D: 11 to 20 × 2 units	(total 100 units)	A/B: 2 units C/D: 2 units	A/B: 11 to 29 × 2 units C/D: 7 to 20 × 2 units	(total 98 units)	A/B: 2 units C/D: 2 units
50 m	2.0 m	10 m	A/B: 1 to 15 × 2 units C/D: 1 to 10 × 2 units	(total 50 units)	A/B: 0 units C/D: 0 units	A/B: 1 to 9 × 2 units C/D: 1 to 6 × 2 units	(total 30 units)	A/B: 0 units C/D: 0 units
			A/B: 16 to 30 × 2 units C/D: 11 to 20 × 2 units	(total 100 units)	A/B: 2 units C/D: 2 units	A/B: 10 to 29 × 2 units C/D: 7 to 20 × 2 units	(total 98 units)	A/B: 2 units C/D: 2 units
100 m	2.0 m	10 m	A/B: 1 to 14 × 2 units C/D: 1 to 10 × 2 units	(total 48 units)	A/B: 0 units C/D: 0 units	A/B: 1 to 8 × 2 units C/D: 1 to 6 × 2 units	(total 28 units)	A/B: 0 units C/D: 0 units
			A/B: 15 to 30 × 2 units C/D: 11 to 20 × 2 units	(total 100 units)	A/B: 2 units C/D: 2 units	A/B: 9 to 28 × 2 units C/D: 7 to 20 × 2 units	(total 96 units)	A/B: 2 units C/D: 2 units

Ring connection

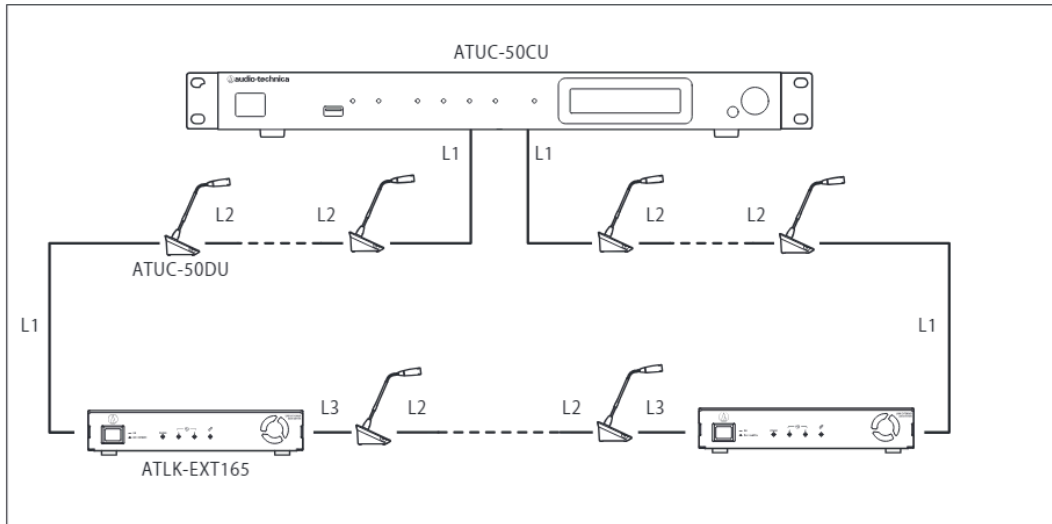

- NOTICE**
- For a CU-DU-DU-...DU-EXT connection, the distance between the [DU-EXT] is L1.
 - When it is EXT-DU-...-DU-DU-, the distance for [EXT-DU] is L3.

Relationship of the LAN cable length, number of units connected and number of EXTs required: Ring connection

Length of cables			1-ring connection (using DUs)		1-ring connection (using IUs)	
CU-DU	DU-DU	EXT-DU	Number of DUs connected	Number of EXTs needed	Number of IUs connected	Number of EXTs needed
L1	L2	L3				
10 m	1.5 m	10 m	1 to 45 units	0 units	1 to 30 units	0 units
			46 to 50 units	1 unit	31 to 50 units	2 units
50 m	1.5 m	10 m	1 to 36 units	0 units	1 to 24 units	0 units
			37 to 50 units	2 units	25 to 50 units	2 units
100 m	1.5 m	10 m	1 to 24 units	0 units	1 to 16 units	0 units
			25 to 50 units	2 units	17 to 48 units	2 units
10 m	2.0 m	10 m	1 to 43 units	0 units	1 to 29 units	0 units
			44 to 50 units	1 unit	30 to 50 units	2 units
50 m	2.0 m	10 m	1 to 34 units	0 units	1 to 23 units	0 units
			35 to 50 units	2 units	24 to 50 units	2 units
100 m	2.0 m	10 m	1 to 24 units	0 units	1 to 16 units	0 units
			25 to 50 units	2 units	17 to 48 units	2 units
10 m	5.0 m	10 m	1 to 33 units	0 units	1 to 25 units	0 units
			34 to 50 units	2 units	26 to 50 units	2 units
50 m	5.0 m	10 m	1 to 27 units	0 units	1 to 20 units	0 units
			28 to 50 units	2 units	21 to 50 units	2 units
100 m	5.0 m	10 m	1 to 20 units	0 units	1 to 14 units	0 units
			21 to 50 units	2 units	15 to 45 units	2 units

Length of cables			2-ring connection (using DUs)			2-ring connection (using IUs)		
CU-DU	DU-DU	EXT-DU	Number of DUs connected	Maximum number of units connected	Number of EXTs needed	Number of IUs connected	Maximum number of units connected	Number of EXTs needed
L1	L2	L3						
10 m	1.5 m	10 m	1 to 25 × 2 units	(total 50 units)	0 units	1 to 16 × 2 units	(total 32 units)	0 units
			26 to 50 × 2 units	(total 100 units)	4 units	17 to 40 × 2 units	(total 80 units)	4 units
50 m	1.5 m	10 m	1 to 23 × 2 units	(total 46 units)	0 units	1 to 15 × 2 units	(total 30 units)	0 units
			24 to 50 × 2 units	(total 100 units)	4 units	16 to 38 × 2 units	(total 76 units)	4 units
100 m	1.5 m	10 m	1 to 20 × 2 units	(total 40 units)	0 units	1 to 13 × 2 units	(total 26 units)	0 units
			21 to 50 × 2 units	(total 100 units)	4 units	14 to 38 × 2 units	(total 76 units)	4 units
10 m	2.0 m	10 m	1 to 25 × 2 units	(total 50 units)	0 units	1 to 16 × 2 units	(total 32 units)	0 units
			26 to 50 × 2 units	(total 100 units)	4 units	17 to 40 × 2 units	(total 80 units)	4 units
50 m	2.0 m	10 m	1 to 23 × 2 units	(total 46 units)	0 units	1 to 15 × 2 units	(total 30 units)	0 units
			24 to 50 × 2 units	(total 100 units)	4 units	16 to 38 × 2 units	(total 76 units)	4 units
100 m	2.0 m	10 m	1 to 20 × 2 units	(total 40 units)	0 units	1 to 12 × 2 units	(total 24 units)	0 units
			21 to 50 × 2 units	(total 100 units)	4 units	13 to 38 × 2 units	(total 76 units)	4 units
10 m	5.0 m	10 m	1 to 24 × 2 units	(total 48 units)	0 units	1 to 16 × 2 units	(total 32 units)	0 units
			25 to 50 × 2 units	(total 100 units)	4 units	17 to 39 × 2 units	(total 78 units)	4 units
50 m	5.0 m	10 m	1 to 22 × 2 units	(total 44 units)	0 units	1 to 14 × 2 units	(total 28 units)	0 units
			23 to 50 × 2 units	(total 100 units)	4 units	15 to 37 × 2 units	(total 74 units)	4 units
100 m	5.0 m	10 m	1 to 19 × 2 units	(total 38 units)	0 units	1 to 12 × 2 units.	(total 24 units)	0 units
			20 to 50 × 2 units	(total 100 units)	4 units	13 to 35 × 2 units	(total 70 units)	4 units

The values in the tables above are calculated based on the following assumptions.

- The number of DUs that can be connected is based on the assumption that the ATUC-M is used.
- The number of IUs that can be connected is based on the assumption that ATUC-M, TALK LED, FLOOR LED, 8-Ω speaker units, 32-Ω impedance headphones, and GPO terminals with LED x 4 (7 mA each) are being used.
- Given that Cat5e or higher cables are used. (Shielded cables with conductor size of 24AWG or higher in diameter are recommended.)
- 1-port daisy-chain connection/1 ring connection: Given that one of the DU CHAIN A/B terminals is connected in a DU/IU daisy-chain or that the A-B terminal is connected in a ring.
- 2-port daisy-chain connection: Given that the same number of DUs/IUs are daisy chained to the DU CHAIN A/B terminals.
- 4-port daisy-chain connection: Given that the same number of DUs/IUs are daisy chained to both the DU CHAIN A/B terminals and the same number of DUs/IUs are daisy chained to the DU CHAIN C/D terminals.
- 2-ring connections: Given that one ring connection is used for the DU CHAIN A-B terminals and for the DU CHAIN C-D terminals.

- NOTICE**
- When connecting DUs/IUs, never exceed the number of connectable DUs/IUs and the connectable length. It may damage the CU or the EXTs.
 - Depending on the CU settings, you can also connect the DUs/IUs to the CU LINK terminals by configuring them as DU CHAIN C/D terminals. However, if the number of the DUs connected to the DU CHAIN A/B terminals has not reached the maximum, be sure to connect them to the DU CHAIN A/B terminals.
 - The above tables and precautions for DUs are also for INTs. However, a maximum number of 6 INTs can be connected to one system.
 - The combinations shown above are representative examples. For other combinations, please inquire with our sales representative.
 - The position in which to connect the EXTs should have the same number of DUs (A, B, and C in the following diagram) between EXT-EXT as there are between CU-EXT connected to the CU 1 port.
- For example, do the connections as follows for an L1 = 10 m, L2 = 1.5 m, and L3 = 10 m, with 50 units connected to a 1 port daisy connection.

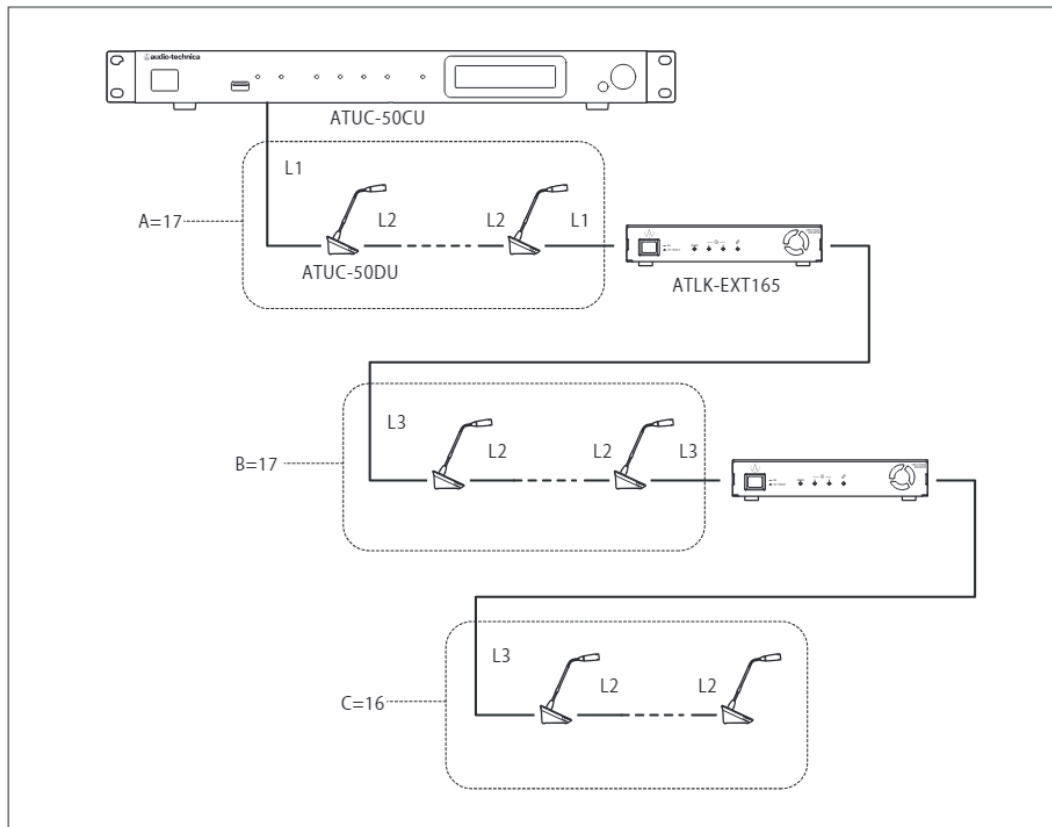

CU Link connection:

Up to 3 CUs can be cascaded (cascade CUs using the CU LINK A/B terminals as shown below). Set one of the CUs as the primary unit.

Since up to 100 DUs/INTs can be connected to each CU, if you use 3 CUs, up to 300 DUs/INTs can be connected in total.

Follow the procedure below to cascade CUs.

- ① Connect the CU LINK A terminal on the 1st extension CU to the CU LINK B terminal on the primary CU.
- ② When cascading 2 extension CUs, connect the CU LINK A terminal on the 2nd extension CU to the CU LINK B terminal on the 1st extension CU.

Primary CU

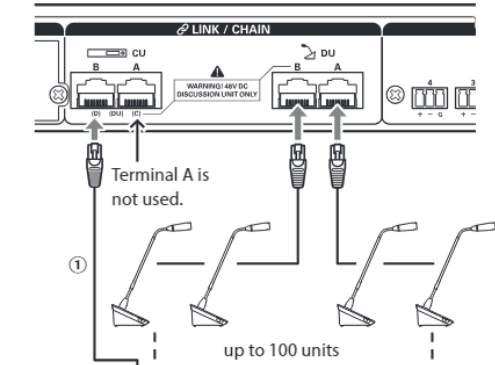

1st extension CU

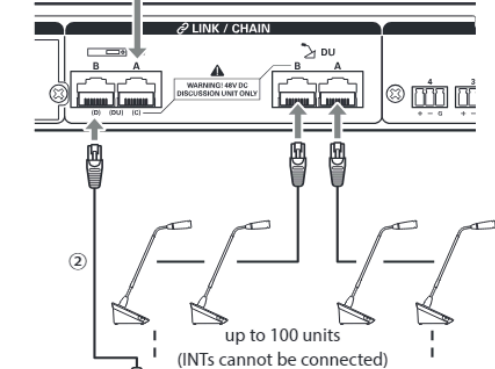

2nd extension CU

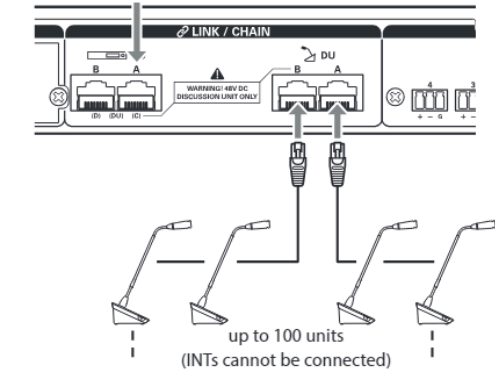

Primary/Extension (CU Link Mode):

	Primary CU	1st extension CU	2nd extension CU
2-CU Link	[Primary]	[Extension Last Unit]	-
3-CU Link	[Primary]	[Extension Pass Through]	[Extension Last Unit]

- You can either daisy-chain (page 27) or ring (page 27) DUs/INTs to each CU.

NOTICE • When using only one CU without a CU Link connection, be sure to set [CU Link Setting] to [Primary]. If [CU Link Setting] is set to [Extension], we do not assume responsibility for any unexpected consequences that may occur.

- Up to 6 INTs can be connected to the primary CU. They cannot be connected to extension CUs.

3 Attach the bottom cover to the DU/INT.

After connecting the Ethernet cables to the DUs/INTs, attach the bottom cover to each DU/INT.

- The Ethernet cable is fixed securely between the DU/INT and the bottom cover. This helps reduce the load that the DU/INT places on the Ethernet cables.
- To lead the cable out to the rear side, use the through hole ①. To lead the cable out to the bottom side, use the through holes ②.

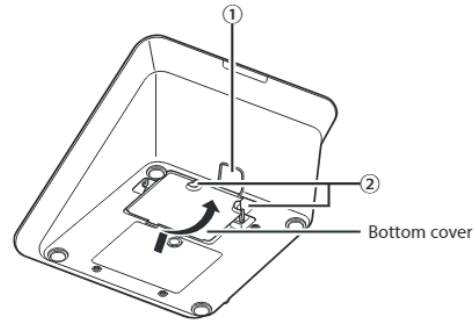

4 Attach the optional bottom weight to the DUs/INTs.

- When using DUs/INTs that are not secured to desktops or tabletops, it is recommended to use the optional bottom weight (330g) for secure placement.
- To purchase the optional accessories, contact our sales team.

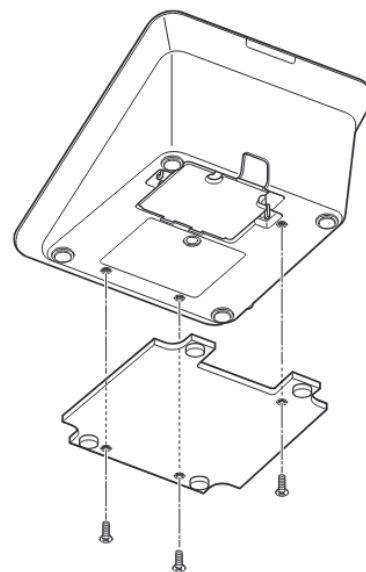

3 Connecting the microphone ATUC-M to the DU/INT

1 Connect the ATUC-M to the microphone jack on the DU/INT.

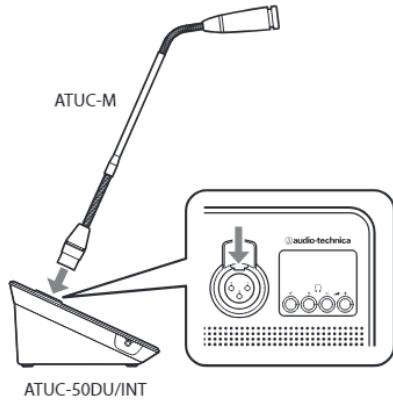

- NOTICE**
- Insert the ATUC-M connector in until you hear a clicking sound.
 - Do not attempt to lift up the DU/INT by grabbing the ATUC-M. Be sure to hold the main body of the DU/INT when lifting it up.
 - Slowly bend or extend the flexible part of the ATUC-M. Do not apply excessive force to the ATUC-M when bending it.
 - When disconnecting the ATUC-M from the DU/INT, securely hold the connector while pressing down the microphone release lever and then remove the ATUC-M.
 - Before connecting/disconnecting the ATUC-M, be sure to turn off the power. If you do not turn off the power, malfunction may occur.

4 Connecting an amplifier

1 Connect an amplifier to the OUTPUT BAL. terminal.

Connect an amplifier to amplify sound.
Connect a speaker via the amplifier.

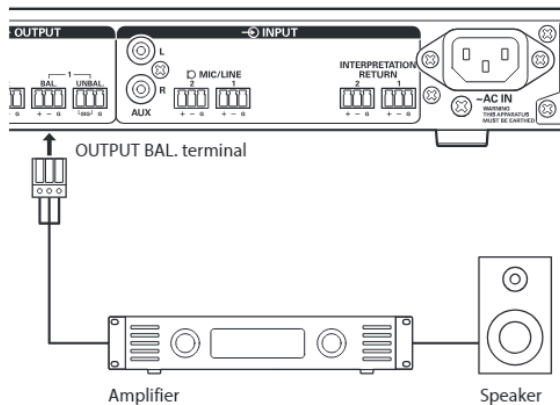

- NOTICE**
- When connecting external devices to IN/OUT terminals, do so after cutting the phantom power supply of the external devices. If you leave the phantom power supply on, it may cause unexpected malfunctions.
 - When connecting external devices, refer also to the instruction manuals supplied with them.

5 Turning on the CU and testing DU operations

After checking that all the connections from steps **1** to **4** have been done properly, follow the procedure below to turn on the power of the CU.

1 Check that all the PA devices such as an amplifier and mixer are off.

2 Connect the supplied AC power cord to the CU.

- NOTICE**
- Be sure to use the supplied AC power cord. Using an AC power cord other than the supplied one may cause problems such as damage to the CU, which can be very dangerous.
 - Be sure to connect the AC power cord into a properly grounded wall outlet. Improper grounding can cause electrical shock.
 - Be sure that the CU is securely grounded to a single ground point. Grounding to multiple ground points can cause ground loops, resulting in noise generation such as a humming noise

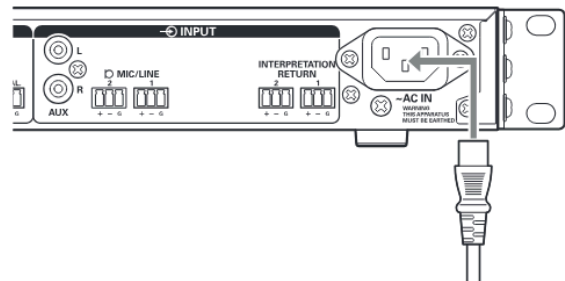

3 Press the power button.

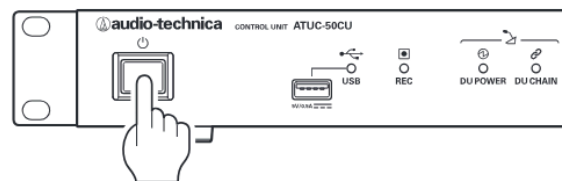

- NOTICE**
- When one or two extension CUs are connected to the system, turn on the power of the primary CU and extension CU(s) at the same time. If the time period between each power-on time is significantly long, a successful CU Link may not be established.

-  • Configure the network setting from the CU (▶ page 22) as necessary.

4 After the CU starts up, press the  (talk) button of each DU to confirm operation.

NOTICE • When the DUs are placed close to each other, excessively raising the volume of the DU speakers may cause howling. In such a case, move the DUs farther away from each other or decrease the volume.

5 After checking that the DUs are operating, turn off the CU before proceeding to the next step for connecting the CU to a network device.

NOTICE • If the power of the amplifier is on, first turn off the power of the amplifier.

Entire system connection diagram (2)

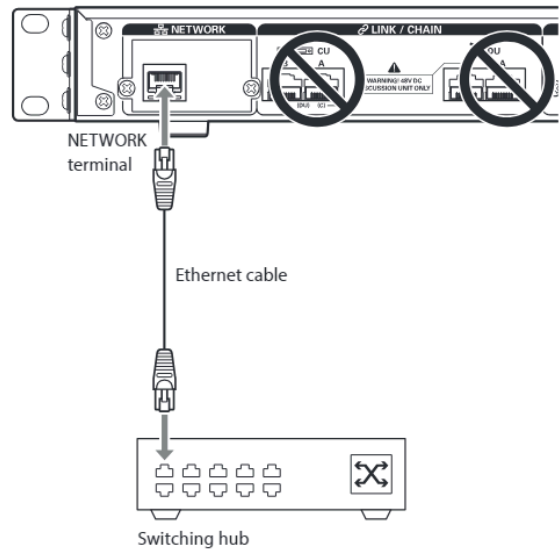
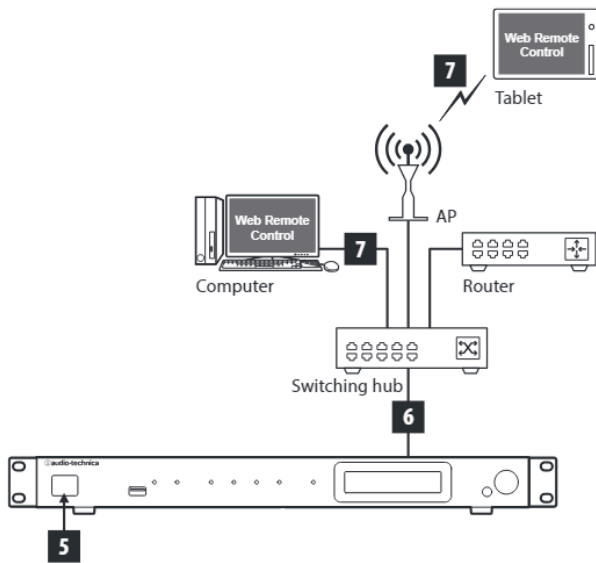

7 Connecting a computer or mobile device to a network

About network settings

- If there is a DHCP server running on the network, the CU automatically configures network settings including the IP address.
- If there is no DHCP server running on the network, manually configure network settings including the IP address from the Set Menu → *System Setting* (▶ page 10).
- When configuring settings manually, inquire with the network manager regarding setting items.

NOTICE • We decline any and all responsibility for communication errors and failures regarding your network environment and external devices.

• Disable the firewall setting on your computer. Otherwise, “Locate” will not recognize the CU.

6 Connecting to a network

Configure the detailed conference system settings via Web Remote by connecting the CU to a network (▶ page 40).

1 Use an Ethernet cable to connect the CU to a switching hub via the NETWORK terminal.

NOTICE • Be careful NOT to connect the Ethernet cable from your network device to the CU LINK terminal or DU CHAIN terminal. This can cause damage to the connected device.

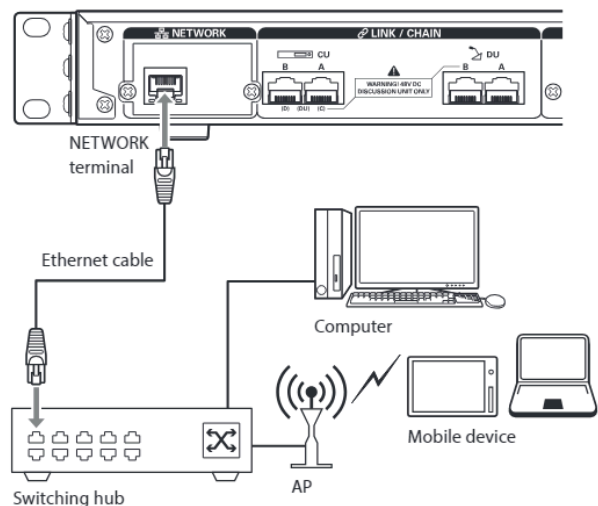

To connect the CU directly to the your Windows PC/Mac using an Ethernet cable

If your computer is equipped with an NIC (Network Interface Card), you can also connect the CU directly to the computer using an Ethernet cable.

NOTICE • Be careful NOT to connect the Ethernet cable from the computer to the CU LINK terminal or DU CHAIN terminal. This can cause damage to the computer.

- 1** Connect an Ethernet cable (straight) to the NETWORK terminal on the CU and Ethernet terminal on a computer.
- 2** In the network settings on your Windows PC/Mac, select "Obtain an IP address automatically" on your Windows PC, or "Using DHCP" on your Mac, and then save the settings.
- 3** Start up the CU and from the Set Menu → *System Info* → *IP Config Mode*, select *Auto* (▶ page 10).
- 4** Press the BACK button to close the Set Menu.



• After changing the network setting item(s), restart the CU to enable the setting values.

Since there is no DHCP server, an IP address is automatically assigned to the Windows PC/Mac and the CU using the APIPA (Automatic Private IP Addressing) feature.

Preparing to use Web Remote

What is Web Remote?

Web Remote is a web application to control this system.

Using Web Remote enables you to remotely perform the following operations from a computer or mobile device (hereinafter, control device):

- Preparing for conferences
- Operating and controlling conferences
- Configuring detailed settings

After connecting the CU to the control device, download "Locate". Using "Locate" enables you to simply access Web Remote (▶ page 42) without typing the IP address of the ATUC-50CU installed.



- You can also start up Web Remote without using "Locate" (▶ page 42).

Operating Environment for Web Remote and "Locate"

- Microsoft Windows 7 or later
- Apple OS X10.11 El Capitan or later
- Android OSS.0 or later
- iOS9 or later

Recommended web browser for Web Remote

- Microsoft Internet Explorer 11 (Windows)
- Google Chrome ver. 57 or later (Windows and Android)
- Mozilla Firefox ver. 52 or later (Windows)
- Safari 10 or later (OS X and iOS)

- NOTICE**
- Up to 3 control devices can simultaneously log in to Web Remote.
 - When 2 web browsers are running on a control device, Web Remote counts the web browsers as 2 separate devices.
 - When you have finished with Web Remote, be sure to log out of Web Remote before closing the web browser window.
- If you simply close the window without logging out, you will remain logged in to Web Remote for 5 minutes until the session times out.

Setting up "Locate"

1 Download the "Locate" installer onto the control device.

For Windows/Mac users:

Download the "Locate" installer that applies to your country/region from the Audio-Technica website:

http://www.audio-technica.com/world_map/

Proceed to step 2.

For iOS users:

Search from App Store and install "Locate".



Proceed to step 4.

For Android users:

Search from Google Play and install "Locate".



Proceed to step 4.

2 Double-click "setup.exe" downloaded.

The setup wizard will appear.

3 Follow the on-screen instructions to install "Locate" onto the control device.

After the installation is complete, the "Locate" icon will appear on the desktop.

4 Check that the ATUC-50CU and the control device are connected to the same network, and that the power of the CU is ON, then double-click the "Locate" icon.

"Locate" will start up. ATUC-50CU connected to the network will be detected automatically.

5 Select the CU you want to control via Web Remote, then click [Open].

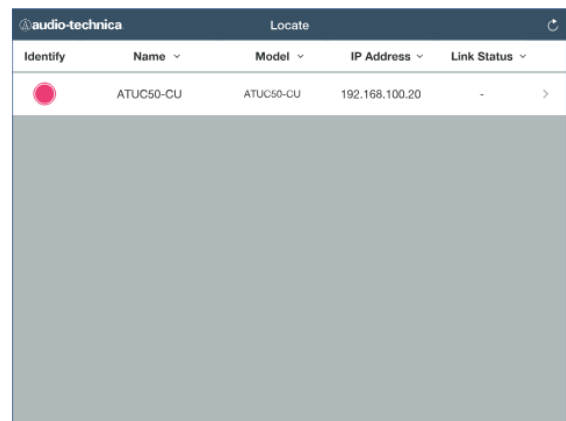

The Web Remote login screen appears.



- When the [Identify] icon is clicked, the icon lights red and the indicators blink on the front panel of the selected CU. This function is useful if there are multiple CUs in the system and you want to identify a CU such as when you select the CU you want to control from the CUs displayed in the "Locate" list.

Configuring and Operating Conferences Using the Web Remote Control Function

About Web Remote

Overall structure of Web Remote

From the Home screen below, you can access the 3 main menus.

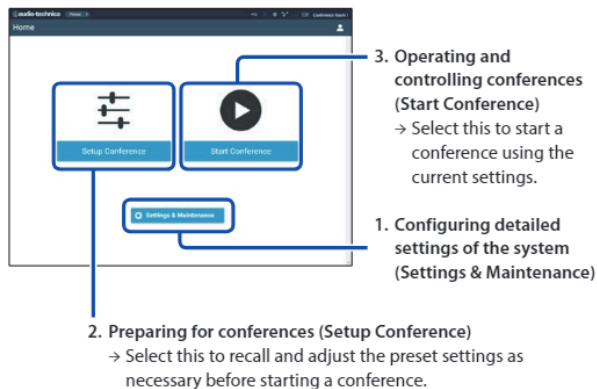

1. Configuring detailed settings of the system (Settings & Maintenance) (▶ page 43):

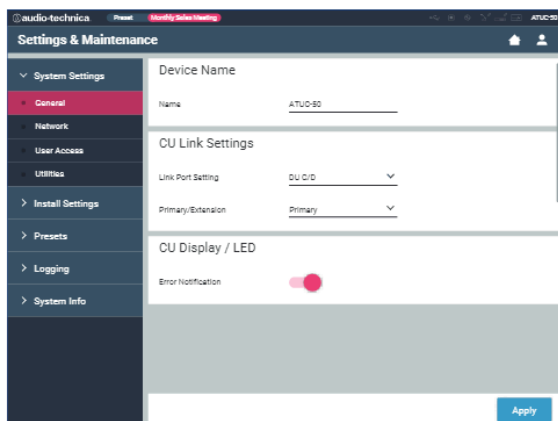

Under [Settings & Maintenance], the following 5 sub-menus are available for configuring detailed settings of the entire system.

[System Settings] (▶ page 44)

Allows you to set the unit name and a login password as well as access authority setting, and configures network-related settings.

You can also update the firmware from here.

[Install Settings] (▶ page 49)

Allows you to select conference mode (▶ page 52).

You can also configure advanced CU audio input/output settings and recording settings.

Furthermore, you can configure DU detail settings, such as speaker settings and LED color, for each DU and the interpretation settings for each INT.

[Presets] (▶ page 61)

Allows you to preset settings configured from [Install Settings] and recall the settings. You can also export the desired preset setting and import it to another ATUC-50.

[Logging] (▶ page 61)

Allows you to turn the logging function on/off and download a log file.

[System Info] (▶ page 61)

Displays the network setting information and firmware version.

2. Preparing for conferences (Setup Conference) (▶ page 62):

Follow the 3 steps below to prepare for a conference.

[Recall Preset] (▶ page 62)

Select the desired preset conference setting according to the upcoming conference.

To handle many different types of conferences using 1 ATUC-50 system, it is recommended to preset multiple types of conference settings.

[Conference Settings] (▶ page 62)

According to the upcoming conference, set the [Conference Mode] (▶ page 52), which defines the talk method, and then configure the detailed settings.

[DU/IU Settings] (▶ page 63)

For each DU/IU connected to the system, set the attendee name and configure the audio settings and priority setting.

3. Operating and controlling conferences (Start Conference) (▶ page 64):

Operate and control the conference by switching the screen among the following 3 screens.

[Conference Manager] (▶ page 64)

Displays an attendee (DU) list. The list shows information including the attendee names, priority setting status and talk request status. Furthermore, you can permit the attendees to talk.

[Audio Control] (▶ page 65)

Configure the primary output settings and perform audio-related operations such as buzzer playback and conference recording operations.

[Conference Settings] (▶ page 65)

You can change detailed settings such as conference mode even during the conference.

Starting up Web Remote and preparing for operations

This chapter explains the Web Remote startup operation and the header always displayed on the top of the screen.

Starting up and logging in to Web Remote

1 Display the Web Remote login screen.

To log in to Web Remote from "Locate":

- Follow steps 4 to 5 in "Setting up 'Locate'" (page 40). Web Remote starts up and the login screen appears.

To log in to Web Remote without using "Locate":

NOTICE • Check that the CU is connected to the same network as the control device. When using a control device with a network terminal, you can also directly connect the CU to the control device using an Ethernet cable (page 39).

- From the CU Set Menu → System Info → IP Address, check the IP address of the CU (page 10).
- Run the browser and type the IP address you checked in step (1) in the address bar. Web Remote starts up and the login screen appears.

2 Select [Operator] or [Administrator], then click [Login].

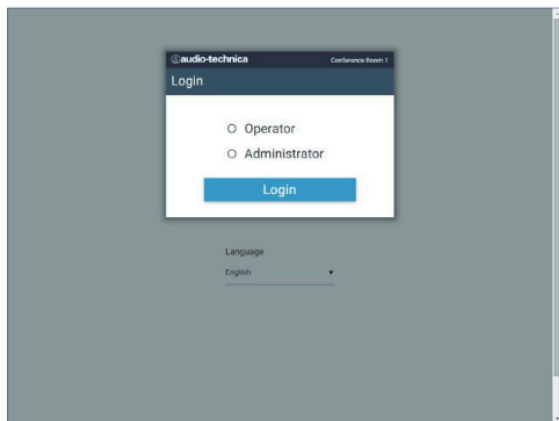

To change the language, click [▼] next to the language display to expand the drop-down list and select the desired language.

The [Operator] access authority can be set from [System Settings] → [User Access] → [Operator Access Settings] (page 45).

When a login password (page 45) is already set, enter the password on the password input screen.

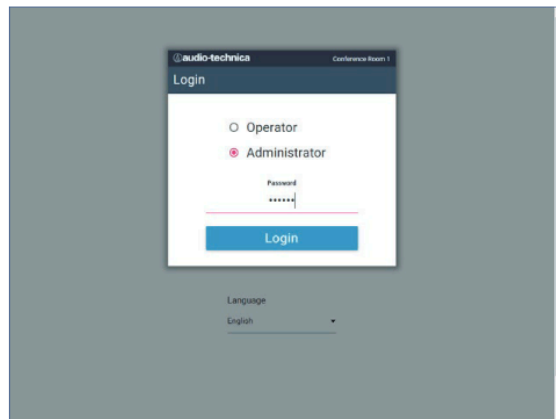

After successfully logging in to Web Remote, the Home screen appears.

About Web Remote Home screen

- Depending on the [Operator] access authority setting, [Settings & Maintenance] may not appear on the Home screen.

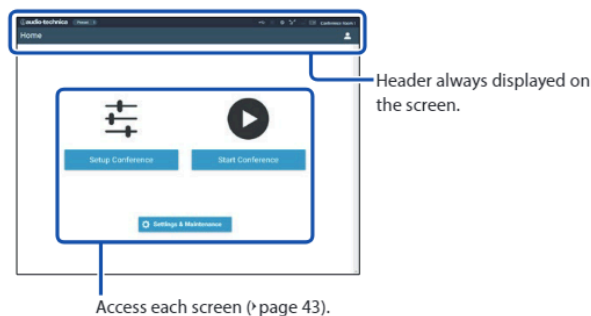

About the display items on the header:

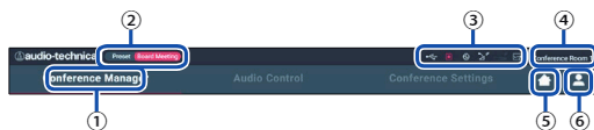

- Displays the screen name (e.g. Home).
- Displays the recalled preset conference name (page 61). If some changes have been applied to the recalled preset, the preset characters will appear in white color.
- Displays various indicators (page 9). If any problem occurs, "▲" appears below the corresponding indicator. Placing the cursor over the indicator will display the pop-up screen which shows the details of the problem.
- Displays the name of the unit such as ATUC-50CU which is being controlled via Web Remote.
- Home button: Click to return to the Home screen.
- Logout button: Click to display the currently logged-in authority and the logout menu.

Configuring detailed system settings ([Settings & Maintenance])

From this menu, detailed system settings can be configured. Utilities for troubleshooting and maintenance are also available.

How to operate the [Settings & Maintenance] menu

1 On the Web Remote Home screen, click [Settings & Maintenance].

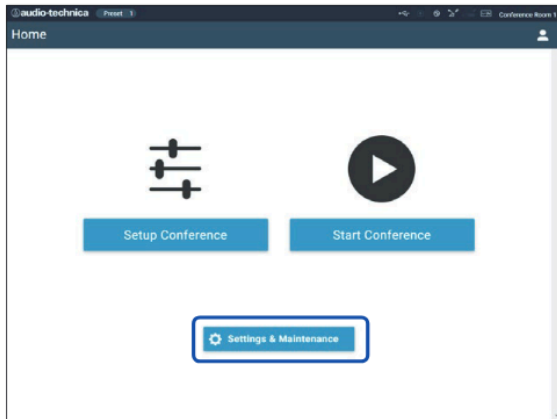

2 From the 5 menu items on the left, click the item you want to configure.

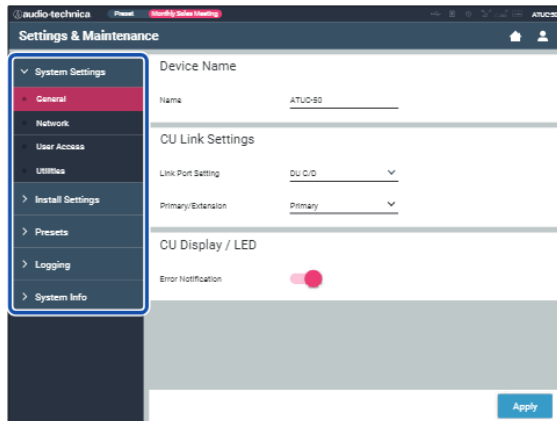

3 Change the settings as necessary, then click [Apply].

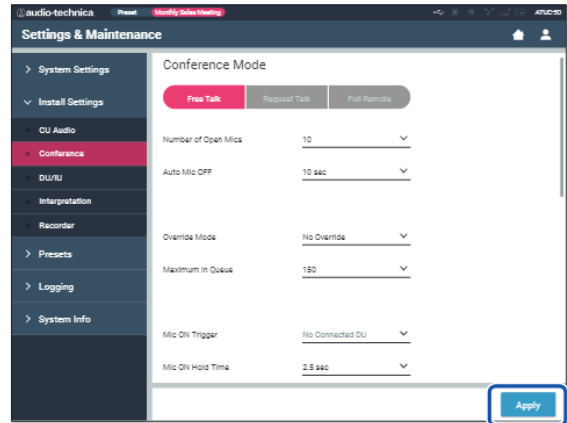

- The buttons displayed may vary depending on the screen.
- On screens where value changes are immediately applied, such as on audio-related setting screens, the [Apply] button may not appear.

Menu item ① ([System Settings])

The setting values and default setting of each item which you can set from [System Settings] are as follows.

The item names with **CU** on the left are the names displayed on the CU display.

Items with **P** are included in the preset settings.

General Settings ([General])

Item name	Description and setting values (default settings are shown in bold)
Device Name	
CU Name	Displays the name of the unit being controlled via Web Remote. ATUC-50CU
CU Link Settings	
CU Link Port Setting CU Link Port Set	Switch the terminal setting between CU LINK A/B terminals and DU CHAIN C/D terminals. CU A/B, DU C/D
CU Primary/Extension CU CU Link Mode P	Set the dependency relationship of each CU (Primary/Extension) when multiple CUs are cascade-connected. Primary, Extension Pass Through, Extension Last Unit NOTICE • When using only one CU without a CU Link connection, be sure to set [CU Link Setting] to [Primary]. If [CU Link Setting] is set to [Extension], we do not assume responsibility for any unexpected consequences that may occur.
CU Display/LED	
CU Error Notification CU CU Error Notice	Set whether to get error notices on the CU's display. On, Off

Network Settings ([Network])



• After changing the network setting item(s), restart the CU to enable the setting values.

Item name	Description and setting values (default settings are shown in bold)
IP Settings	
IP Config Mode	Specify the IP address-acquiring method. Auto: IP address is assigned by a DHCP server or the like. Static: Specify static IP address. This enables you to specify the IP address, subnet mask, and gateway address.
IP Address	Displays the IP address. Does not display when [IP Config Mode] is set to [Auto].
Subnet Mask	Displays the subnet mask. Does not display when [IP Config Mode] is set to [Auto].
Gateway Address	Displays the gateway address. Does not display when [IP Config Mode] is set to [Auto].
Allow Discovery	Enable/disable automatic detection from "Locate". On, Off
IP Control Settings	
CU Port Number CU IP Ctrl Port No	Displays the IP control port number. 00001-65535 (17300)
CU Notification CU IP Ctrl Ntfy	Enable/disable notification from the device during IP control. On, Off
CU Audio Level Notification CU Audio Level Ntfy	Enable/disable notification of the audio level from the device when IP control is enabled. On, Off

Multicast Address CU M-cast Adrs	Specify multicast address. 0.0.0.0 - 255.255.255.255 (225.0.0.100)
Multicast Port Number CU M-cast Port No	Specify multicast port number. 00001-65535 (17000)
Auto Mode Change When Network Connection Lost	
Enabled CU Auto Mode Change	Automatically switches the conference mode to [Free Talk] Mode when a network error occurs while operating in [Full Remote] Mode. On, Off
Hold time CU Hold Time (Err)	Set the time interval until [Full Remote] Mode switches to [Free Talk] Mode after a network error occurs. 20, 30, 40 sec  • During Web Remote control, the time interval may be longer by up to 15 seconds.
NTP Settings	
Enabled CU NTP	Enable/disable NTP (Network Time Protocol). On, Off
Server Address CU NTP Adrs	Specify the NTP sever address. 0.0.0.0 - 255.255.255.255 (Empty)
Port Number CU NTP Port	Specify the NTP port number. 00001-65535 (123)
Time Zone	Specify the time difference to UTC (Coordinated Universal Time). UTC -12:00 to +14:00; in 0:30 minute increments (00:00)
Daylight Saving Time CU DST	Enable/disable the daylight saving time option. On, Off
Start Date & Time CU DST Start Date CU DST Start Time	Set the start date and time for daylight saving time. 1/1 - 12/31 (3/27) 0:00 - 23:00; in 1 hour increments (2:00)
End Date & Time CU DST End Date CU DST End Time	Set the end date and time for daylight saving time. 1/1 - 12/31 (10/30) 0:00 - 23:00 (2:00)

User Access Settings ([User Access])

Item name	Description and setting values (default settings are shown in bold)
Login Password	
Administrator Password CU Admin.Pwd.Login	Enable/disable login password requirement for Administrator. On, Off
CU Admin.Password	Set a login password for Administrator. 4 to 8 alphanumeric characters (Empty)
Operator Password CU Opr.Pwd.Login	Enable/disable login password requirement for Operator. On, Off
CU Opr.Password	Set a login password for Operator. 4 to 8 alphanumeric characters (Empty)
Operator Access Settings	
Configure settings of access authority granted to Operator.	
Home Page	
Start Conference Setup Conference	Enable/disable function limitation for conference preparation ([Setup Conference]) and conference operation and control ([Start Conference]). Full, Limited
Settings & Maintenance	Allow/restrict access to detailed settings ([Settings & Maintenance]). When this item is set to [No], the [Settings & Maintenance] button will not appear on the Home screen. Yes, No

Settings & Maintenance	Enable/disable access authority for detailed setting of each item ([Settings & Maintenance] on Web Remote, <i>Set</i> on the CU display).
CU Display Menu	
Install Settings	
CU Audio Setting, Recorder Setting	Yes, No
Presets	Yes, No
Logging	Yes, No
System Info	Yes, No

Utilities ([Utilities])

The following operations can be performed from [System Settings].

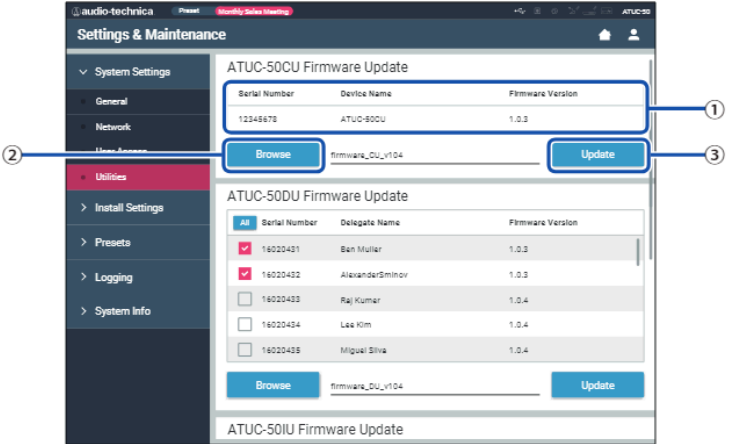
Item name	Description and operation procedure
ATUC-50CU Firmware Update	<p>Updates the CU firmware.</p>  <ol style="list-style-type: none"> ① Check the [Serial Number], [Device Name], and the current [Firmware Version] on the screen to be sure that the displayed CU is the one you want to update. ② Click [Browse] to display the file select screen and select the version upgrade file. Click [Open] to start loading the file. ③ When the loading is complete, [Update] will be selectable. Click [Update]. ④ After the confirmation message appears on the pop-up screen, click [Yes] to perform the update. When the update is complete, [Completed. Device will automatically reboot momentarily.] will appear and the CU will automatically restart in 3 seconds.

ATUC-50DU Firmware Update

Updates the DU firmware.

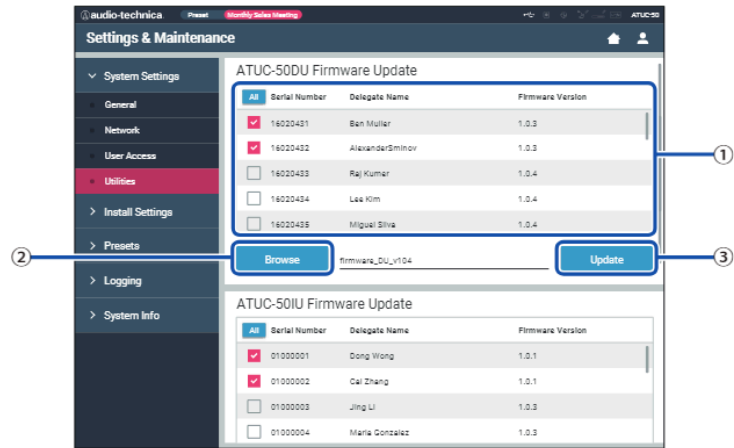

- ① Click the checkbox next to the [Serial Number], [Delegate Name], and the current [Firmware Version] of each DU you want to update.
When you want to select all DUs, click [All] on the upper left of the DU Firmware Update section on the screen.
- ② Click [Browse] to display the file select screen and select the version upgrade file.
Click [Open] to start loading the file.
- ③ When the loading is complete, [Update] will be selectable. Click [Update].
- ④ After the confirmation message appears on the pop-up screen, click [Yes] to perform the update.
When the update is complete, [Completed. Please turn power off.] will appear.
- ⑤ Turn off the power of the CU to restart it.

ATUC-50IU Firmware Update

Update the IU firmware.

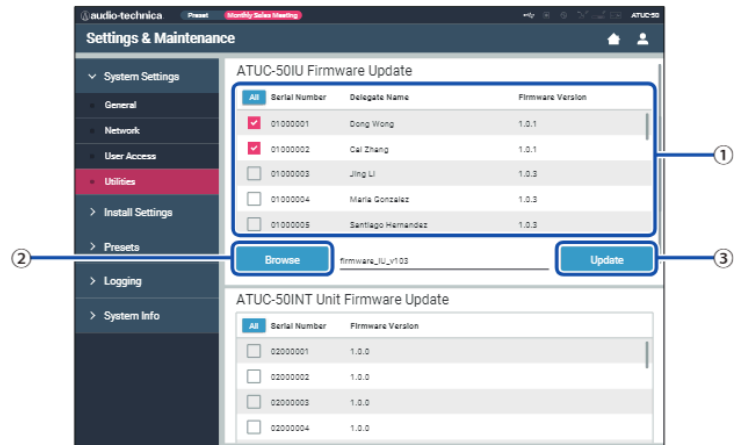

- ① Confirm that [Serial Number], [Delegate Name], and the current [Firmware Version] appear on the screen, and then select the check box on the left side of the IU units that you want to update.
If you want to update all of the IUs, click [All] at the top right.
- ② Click [Browse] to display the file select screen and select the version upgrade file.
Click [Open] to start loading the file.
- ③ When the loading is complete, [Update] can be selected. Click [Update].
- ④ After the confirmation message appears on the pop-up screen, click [Yes] to perform the update.
When the update is complete, [Completed. Please turn power off.] appears.
- ⑤ Turn off the power of the CU, and then restart it.

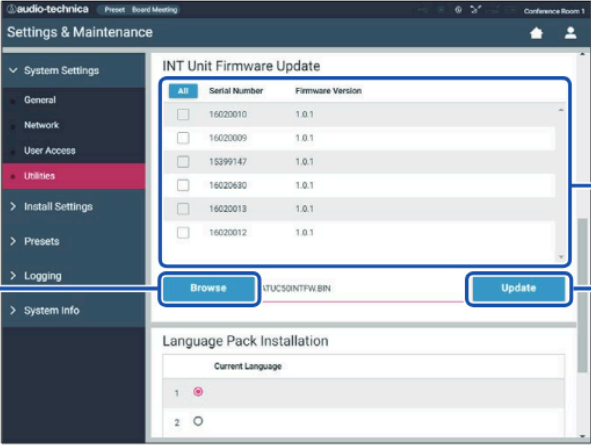
<p>INT Unit Firmware Update</p>	<p>Updates the INT firmware.</p>  <p>① Click the checkbox next to the [Serial Number], [Delegate Name], and the current [Firmware Version] of each INT you want to update. When you want to select all INTs, click [All] on the upper left of the INT Unit Firmware Update section on the screen.</p> <p>② Click [Browse] to display the file select screen and select the version upgrade file. Click [Open] to start loading the file.</p> <p>③ When the loading is complete, [Update] will be selectable. Click [Update].</p> <p>④ After the confirmation message appears on the pop-up screen, click [Yes] to perform the update. When the update is complete, [Completed. Please turn power off.] will appear.</p> <p>⑤ Turn off the power of the CU to restart it.</p>
<p>Language Pack Installation</p>	<p>Install the language pack.</p> <p>① Select the bank onto which you want to install the language pack.</p> <p>② Click [Browse] to display the file select screen and select the language file you want to install.</p> <p>③ Click [Install] to install the language pack. When the installation is complete, [Completed. You will be automatically logged out momentarily.] will appear and you will be automatically logged out of Web Remote in 2 seconds. To continue the operation, log in to Web Remote again.</p>
<p>Reset All Settings to Default CU Reset All Dflt.</p>	<p>Restores CU(s) and DU(s) and IU(s) and INT(s) to the default settings (this does not change the firmware version).</p> <p>① When [Do you really want to reset all settings to default?] appears, click [Yes]. The confirmation message will appear again.</p> <p>② Click [Yes] to restore the default settings. [Completed. Please turn power off.] will appear.</p> <p>③ Turn off the power of the CU to restart it.</p>

Menu item ② ([Install Settings])

















The setting values and default setting of each item you can set from [Install Settings] are as follows.

















The item names with **CU** on the left are the names displayed on the CU display.

Items with **P** are included in the preset settings.

CU Audio Settings ([CU Audio])

Item name		Description and setting values (default settings are shown in bold)
Input Settings		Set the type and level for the Mic/Line audio inputs 1 and 2. 1 and 2 can be configured individually.
Mic/Line 1-2		
Type	P	Set the input type.
CU Input Type		Mic , Line +4dBu, Line 0dBV
Input Gain	P	Set the input gain of the Mic inputs (only when [Type] is set to [Mic]). -24 to +20dB (0dB)
Level	P	Set the Mic/Line input level. The level can be set individually for each input type (Mic or Line). -∞, -120 to +10dB (0dB)
Level Meter		Displays the input level with a level meter.
EQ Library	P	Select the EQ pattern for the Mic/Line inputs. The EQ pattern can be selected for each input type (Mic or Line). Flat HH Dyn M: Dynamic Handheld Microphone for Male HH Dyn F: Dynamic Handheld Microphone for Female HH Cond M: Condenser Handheld Microphone for Male HH Cond F: Condenser Handheld Microphone for Female Lavalier M: Lavalier Microphone for Male Lavalier F: Lavalier Microphone for Female (IP Remote*) * [IP Remote] appears when the equalizer is adjusted from [IP Control Settings]. [IP Remote] cannot be selected from the drop-down list.
Low Cut	P	Enable/disable low frequency reduction for the Mic input. On , Off
Phantom	P	Enable/disable phantom power (+48V). On , Off
CU Phantom Power		
Mix to Floor	P	Set whether to mix the input sound to the floor channel. On , Off
Mix to Language 1 (Only Mic/Line 1)	P	Set whether to mix the voice being input with Language 1. On , Off
Mix to Language 2 (Only Mic/Line 2)	P	Set whether to mix the voice being input with Language 2. On , Off
Aux		Configure the external input settings such as audio type and level.
Type	P	Set the nominal level of the external input. 0dBV , -10dBV, -20dBV
Level	P	Set the input level of the external input. -∞, -120 to +10dB (0dB)
Level Meter		Display the input level with a level meter.
Low Cut		Enable/disable low frequency reduction for the external input. On , Off
Mix to Floor	P	Set whether to mix the external input sound to the floor channel. On , Off
Mix to Language 1	P	Set whether to mix the voice being input with Language 1. On , Off
Mix to Language 2	P	Set whether to mix the voice being input with Language 2. On , Off

Return 1-2		Configure the level of the return input and the EQ pattern for the return input.
Type		Set the nominal level of the return inputs. +4dBu, 0dBV
Level		Set the input level of the return input. -∞, -120 to +10dB (0dB)
Level Meter		Displays the input level with a level meter.
Low Cut		Enable/disable low frequency reduction for the return input. On, Off
Group settings		
Gain share		
Bypass		Do settings to bypass the gain share. Group 0: On, Off Group 1 to Group 3: On, Off
FBS		
On		Configure the feedback suppressor (FBS) settings. Selecting the check box sets FBS of the corresponding [Audio Group] to [On] and makes the setting button  selectable. Click the setting button  to open the [Feedback Suppression Settings] screen and configure advanced settings. Group 0: On, Off Group 1 to Group 3: On, Off
Feedback Suppression Settings		
Frequency	 *	Detects feedback and displays the frequency with the notch filter applied. When [Static] is set to [Off], the frequency dynamically changes according to feedback detected. * When [Static] is set to [On], the [Frequency] value is included in the preset setting as the frequency of the static filter.
Fixed		Lock the filter frequency by switching to the static filter. On, Off
Reset		Unlock all locked frequencies.
Detection		Configure the detection sensitivity of feedback frequency. Low, Mid, High
Response		Configure the detection speed of feedback frequency. Slow, Fast
Group 0: Mix to Floor		Mix the voice of [Group 0] with the Floor. On, Off
Group 1: Mix to Language 1		Mix the voice of [Group 1] with Language 1. On, Off
Group 2: Mix to Language 2		Mix the voice of [Group 2] with Language 2. On, Off
Group 3: Mix to Language 3		Mix the voice of [Group 3] with Language 3. On, Off
Output Settings		
Output 1-4		
Source		Set the audio source to output. Floor, Group 0, Group 1, Group 2, Group 3, Language 1, Language 2, Language 3 (The default settings are as follows: Output 1: Floor , Output 2: Group 1 , Output 3: Group 2 , Output 4: Group 3)
PEQ (Output 1 only)		
PEQ Enabled		Switch the PEQ setting between on and off. On, Off

Frequency (Band#1 - Band#8)		Set the frequency for each of [Band#1] to [Band#8]. 20Hz to 20kHz (The default setting for each of [Band#1] to [Band#8] is as follows. 25, 63, 160, 400, 1000, 2500, 6300, 16000)
Gain (Band#1 - Band#8)		Set the gain for each of [Band#1] to [Band#8]. -18dB to +10dB; adjustable in 0.5dB increments (0dB)  • For [Band#1], [Gain] is configurable only when [Filter Type] is set to [LSH] or [PEQ]. • For [Band#8], [Gain] is configurable only when [Filter Type] is set to [HSH] or [PEQ].
Q (Band#1 - Band#8)		Set the Q value for each of [Band#1] to [Band#8].  • For [Band#1] and [Band#8], the Q value is configurable only when PEQ is enabled. 0.3 to 30 (10)
Filter Type (Band#1)		Set the filter type for [Band#1]. HPF, LSH, PEQ
Filter Type (Band#8)		Set the filter type for [Band#8]. LPE, HSH, PEQ
Reset		Restores specified band to the factory default settings.
Reset All		Restores all bands to the factory default settings.
DYN (Output 1 only)		Configure the DYN (dynamics) settings. Ticking the checkbox sets DYN of Output 1 to [On] and makes the setting button () selectable. Click the setting button () to open the [Dynamics Settings] screen and then configure various settings as follows.
Enabled		Enable/disable the dynamics settings. On, Off
Gain Reduction		Displays audio compressed by the compressor in real time.
Comp Threshold		Configure the compressor threshold. The compressor functions only for audio signals exceeding the specified value. -60 to 0dB (-10)
Ratio		Set the compression ratio. 1.4:1, 2:1 , 4:1, 6:1, 10:1, ∞:1
Attack Time		Set the delay for the start of compression after audio signals exceed the threshold. 0, 0.25, 0.5, 1, 2, 4, 8, 16, 32, 100msec (1msec)
Release Time		Set the delay for the end of compression after audio signals fall back within the threshold. 50, 100, 200, 400, 800, 1000, 2000msec (400msec)
Limiter Threshold		Set the limiter threshold. Audio signals exceeding the specified value will be cut out by the limiter. -60 to 0dB (-10)
Level		Set the output level. -∞, -120 to +10dB (-40dB)
Max Volume (Output 1only)		Set the maximum volume level. -∞, -120 to +10dB

Conference Settings ([Conference])

Select the conference mode according to the conference operation and control method and configure detailed settings.



The following setting items are also included in [Setup Conference] where you can configure the same settings.

• [Free Talk]

In this mode, attendees can talk when the $\mu\zeta$ (talk) button is pressed or when their DUs automatically detect their voices.

• [Request Talk]

In this mode, attendees request to talk by pressing the $\mu\zeta$ (talk) button on the DU and will be permitted to talk by the steering committee. The steering committee can also reject the talk request.

To operate the conference in this mode, connect the CU to a control device such as a computer.

• [Full Remote]

In this mode, utterances are totally controlled via Web Remote. The DU $\mu\zeta$ (talk) button operations will be disabled.

To operate the conference in this mode, connect the CU to a control device such as a computer.

Item name		Description and setting values (default settings are shown in bold)
Conference Settings		Select the conference mode and configure detailed settings
Conference Mode	P	Select the conference mode. Free Talk , Request Talk, Full Remote
Number of Open Mics(*1) CU NOM	P	Set the maximum number of the DUs (speakers) that can talk at the same time. 10 to 1
Auto Mic OFF(*1) CU Auto Mic Off	P	Set the time interval until the microphone automatically turns off after the speaker stops talking (after a soundless state is detected). 5 to 60sec, Off; adjustable in 5-second increments (Off)
Override Mode (Free Talk Mode)(*1)	P	Select the override method(*2) in [Free Talk] Mode. No Override , FIFO, LIFO
Override Mode (Request Talk Mode)(*1)	P	Select the override method(*2) in [Request Talk] Mode. FIFO , LIFO
Override Mode (Full Remote Mode)(*1)	P	Select the override method(*2) in [Full Remote] Mode. FIFO , LIFO
Maximum in Queue(*1) CU Max Queue	P	Set the maximum number of DUs that can be in talk standby mode at the same time. 0 to 150 (50 units)
Mic ON Trigger / Mic ON Trigger for Priority(*1) CU MicON Trigger		Set whether to manually turn on the microphone by pressing the $\mu\zeta$ (talk) button or to automatically turn on the microphone when a voice is detected, for all DUs. When [Conference Mode] is set to [Request Talk] or [Full Remote], this item switches to [Mic ON Trigger for Priority], which is the setting for priority DUs. All Button , All Voice, (Individual*) * The setting value displayed is depending on the setting values for each DU. When all DUs are set to [Button], [All Button] appears, and when all DUs are set to [Voice], [All Voice] appears. When some DUs are set to [Button] and others are set to [Voice], [Individual] appears. [Individual] cannot be performed as a function.
Mic ON Hold Time(*1) CU MicON Hold Time	P	Specify the time until the microphone automatically turns off on DUs where [Mic ON Trigger] is set to [Voice]. The microphone automatically turns off when the attendee keeps silent for the specified time. 1.0 to 10.0 seconds; adjustable in 0.5-second increments (2.5 seconds)
Priority Mode		Set the operation when the user of the priority DU (▶ page 54) presses and holds the DU $\mu\zeta$ (talk) button.
Interrupt Option(*1)	P	Set whether the priority DU user cuts short or temporarily mutes other DU users by pressing and holding the $\mu\zeta$ (talk) button. Cut , Mute

SFX 1-3 Setting		It is possible to replay any audio file, such as a buzzer or chime that has been saved to a USB device (mass storage device). A maximum of 3 audio files can be registered and assigned to the 3 buttons displayed on the [Audio Control] screen. (▶ page 65).																
Name		Specify names for buttons to which audio files are assigned. (Up to 15 characters) SFX1 to 3																
Source		Follow the procedure below to register audio files. ① Copy audio files (up to 30 files) that you want to play to the root directory of a USB device (mass storage device) ② Connect the USB device (mass storage device) to CU ③ Select an audio file from the [Source] pulldown list Playback(*1) <table border="1"> <tr> <td rowspan="2">WAV</td> <td>Data length</td> <td>16bit, 24bit</td> </tr> <tr> <td>Sampling frequency</td> <td>48kHz</td> </tr> <tr> <td rowspan="2">MP3(*2)</td> <td>Bit rate</td> <td>32-320kbps</td> </tr> <tr> <td>Sampling frequency</td> <td>48kHz</td> </tr> <tr> <td colspan="2">Maximum file size</td> <td>2GB</td> </tr> <tr> <td colspan="2">Maximum number of files</td> <td>30files</td> </tr> </table> *1 Supported file systems: FAT16/FAT32 *2 Supported format: MPEG-1 Audio Layer-3.	WAV	Data length	16bit, 24bit	Sampling frequency	48kHz	MP3(*2)	Bit rate	32-320kbps	Sampling frequency	48kHz	Maximum file size		2GB	Maximum number of files		30files
WAV	Data length	16bit, 24bit																
	Sampling frequency	48kHz																
MP3(*2)	Bit rate	32-320kbps																
	Sampling frequency	48kHz																
Maximum file size		2GB																
Maximum number of files		30files																

*1 About setting changes

Settings can be changed when all DUs are in the Talk OFF state.

*2 About the override setting

Specify which DU (speaker) is cut short and which DU's request will be permitted if the number of DUs (speakers) who can talk at the same time has already reached the specified maximum limit ([Number of Open Mics]) and more attendees press the (talk) button.

FIFO (First-In First-Out):

Cuts short the speaker who was least recently permitted to talk and permits the person who has just pressed the (talk) button to talk.

LIFO (Last-In First-Out):

Cuts short the speaker who was most recently permitted to talk and permits the person who has just pressed the (talk) button to talk.

No Override: (unselectable while in [Request Talk] Mode or [Full Remote] Mode)

The person who has just pressed the (talk) button will be in talk standby and will be permitted to talk when his/her turn comes.

DU/IU Settings ([DU/IU])

Item name		Description and setting values (default settings are shown in bold)
Global DU/IU Settings		Configure DU common settings. Basically apply the common setting of the DUs to the IUs, as well.
Speaker Level DU SP Output Lvl		Set the speaker output level. 0 to 20 (10)
Monitor CH Floor Lock DU Floor Lock		Switch the lock function for the monitor channel selection buttons. On, Off
Voice Detection Sensitivity VoiceDetectSens		Set the detection level when voices are detected in automatic mode. -5, -4, -3, -2, -1, 0, 1, 2, 3, 4, 5 (0)
Auto relative to Mic2 Input Auto to Mic2 In		The voice detection level automatically adjusts to the level at which background noise is picked up by the MIC2 input terminal. On, Off
DU Talk LED Color(*1)		Set the LED colors for DUs (talk). (Except for IUs)
Talk ON		Set the (talk) LED color when talking. 10 colors (Red)
Queuing		Set the (talk) LED color when waiting to talk. 10 colors (Green)
Non-Priority IU GPIO 0		Set the GPIO of the IUs with no priority to 0. GPIO 0 , Self Mute

Individual DU/IU Settings (Max. 300 units)		Configure settings individually for each DU/IU.
Connected DUs		Displays setting information of all DUs connected to the system. You can check and change settings.
Device icons		Icons that indicate the categories of the units connected to the system.
LED		Check that the DU/IU LED lights up. The rear LED and $\mu\zeta$ (talk) LED on the DU as well as the ring LED on the ATUC-M blink while the corresponding $\mu\zeta$ (talk) icon on the screen is lit.
Priority		Enable/disable the DU/IU priority settings (*2). You can turn on priority for up to one unit fewer than the maximum number of simultaneous speakers (page 52). On, Off
Serial#		Displays the serial number.
Delegate Name		Assign names (e.g. attendee names) to differentiate DU/IUs. You can use up to 30 characters. (8-digit number)
Audio Group		The output signals from each DU/IU can be categorized into 4 types (audio groups). One or more audio groups can be selected as output destination(s), and furthermore, the output terminal on the CU can be specified for each group (page 50). Group 0, Group 1, Group 2, Group 3
Color		Select a color for the rear LED from the drop-down list. 10 colors (Red)
Operations for the DU(*3)		Select 1 or more DU/IUs from the list and perform the following operations. Edit Detail Settings, Copy, Select all, Deselect all, Delete

*1: About setting changes

Settings can be changed when all DU/IUs are in the Talk OFF state.

*2: About the priority setting

Priority DU/IU(s) are given authorization to do the following:

- Talk anytime
- Cut short or temporarily mute all other attendees simultaneously

It is assumed that the priority setting is enabled on DU/IUs that are used by people in charge of the proceedings of a conference, such as a chairman or company directors who are permitted to talk anytime.

*3: DU/IU operations

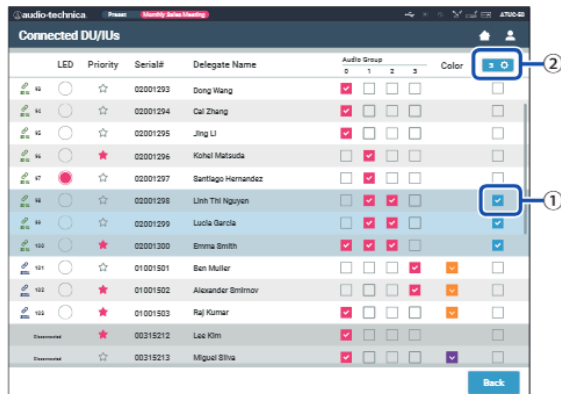

1 Click ① of the DU/IU(s) for which you want to adjust the settings.

A check mark will be inserted in the checkbox.

You can also select multiple DU/IUs and simultaneously change settings of the selected DU/IUs.

2 Click ② to display the drop-down list and proceed to the following operations.

• The number displayed on ② is the number of selected DU/IUs.

Edit Detail Settings:

Simultaneously configure detailed settings for the selected DU/IUs (refer to the [DU Detail Settings] table below).

When multiple DU/IUs are selected, setting items for which the current values differ among the DU/IUs will be grayed out.

- Items which remain grayed out: Setting values of each DU/IU are retained.
- Grayed out items which become selectable after operation: Setting values of all selected DU/IUs will be changed to the displayed values.

Copy:

Copies settings of the selected DU/IU and pastes to other DU/IUs.

- ① Select 1 DU from which you want to copy settings.
- ② Select [Copy] from the drop-down list.
All checkboxes, icons and the like except DU/IU select checkboxes will be unselectable.
- ③ Select the DU/IU(s) to which you want to paste the settings.
- ④ Press the [Paste] button.

Delete:

Deletes the selected DU/IU(s) from the list. Only DU/IU(s) in a disconnected state can be deleted.

Select all:

Selects all DU/IUs.

Deselect all:





Deselects all DU/IUs.



• Depending on the DU/IU selection state, some items above may not appear.

DU/IU Detail Settings ([DU/IU Detail Settings])

Item name		Description and setting values (default settings are shown in bold)
Microphone		Configure microphone-related settings.
Level Meter		Displays the level with a level meter.
Input Gain		Set the microphone input gain. -20dB to +20dB (0dB)
AGC		Enable/disable AGC (Automatic Gain Control). On, Off NOTICE • When operating the system with [AGC] set to [On], set the [Mode When Talk ON] setting under [Speaker] to [Attenuation] or [Off].
EQ Library		Set the EQ pattern for the microphone input. Flat , Neutral Male, Neutral Female, Clear Male, Clear Female, Warm Male, Warm Female, AT ES Series, AT UniPoint, (IP Remote*) * [IP Remote] appears when the equalizer is adjusted from [IP Control Settings]. [IP Remote] cannot be selected from the drop-down list.
Mic ON Trigger		Set whether to manually turn on the microphone by pressing the $\mu\zeta$ (talk) button or to automatically turn on the microphone when a voice is detected. Button , Voice
Phantom Power		Enable/disable the phantom power supply to the microphone. On, Off
Speaker		
Enabled		Enable/disable the DU/IU speaker. On, Off
Mode When Talk ON		The attendee switches speaker mode while talking. When [Attenuation] is selected, the ducking feature lowers the volume level by -20dB (this item appears only when the speaker is enabled). On, Attenuation , Off
Audio Group		The CU categorizes the audio signals transmitted from the DU/IUs and then outputs the signals to the specified channels.
Assign		Up to 4 channels can be specified for each DU. Multiple groups can be selected and output channels can be selected for each group (→ page 50). Group 0 , Group 1, Group 2, Group 3
Rear LED Color (This is a setting item only for DUs.)		
Talk ON / Queuing		Select a color for the rear LED from the drop-down list. 10 colors (Red)

Talk OFF		Set how Talk OFF is lit. Off, Dim
<hr/>		
Priority		Configure the priority (▶ page 54) settings.
Enabled		Enable/disable the priority setting. The maximum number of DUs that can be designated as priority DU is 1 unit less than the maximum number of DUs (speakers) that can talk at the same time (▶ page 52). On, Off
Can Cut/Mute		Set whether the priority DU user can temporarily cut short/mute other DUs. On, Off
Can be Cut/Muted		Set whether the priority DU are temporarily cut short/muted by other DUs. On, Off
<hr/>		
GPI Pin Settings (This is a setting item only for IUs.)		
GPI 0 - 7		Set the function to assign GPI ports 0 to pin 7. GPI x (x is any port number 0 to 7): use as a general purpose input pin Self-Mute : The unit mutes the voice from its own microphone (self-mutes) Permit Next : Permits the DU on the top of the list to talk Master Volume Up : Turns up the volume for the master level Master Volume Down : Turns down the volume for the master level Recall Preset 1 : Recalls preset 1 Recall Preset 2 : Recalls preset 2 Recall Preset 3 : Recalls preset 3 Recall Preset 4 : Recalls preset 4 Recall Preset 5 : Recalls preset 5 Recall Preset 6 : Recalls preset 6 Recall Preset 7 : Recalls preset 7 Recall Preset 8 : Recalls preset 8 REC Start : Starts recording REC Stop : Stops recording SFX 1 : Plays and stops SFX 1 SFX 2 : Plays and stops SFX 2 SFX 3 : Plays and stops SFX 3

GPO Pin Settings (This is a setting item only for IUs.)	
GPI 0 - 7	Ⓟ
	Set the function to assign GPO port 0 to port 7.
	GPO x (x is any port number 0 to 7): use as a general purpose output pin
	Self-Mute Indicator: Indicates when self-muted Lit: Self-muted
	Cut/Mute Indicator: Indicates when a mic is disconnected or muted Lit: Muted Blinking: Cut
	Preset 1 Indicator: Indicates when preset 1 is called Lit: Call done Blinking: Selecting
	Preset 2 Indicator: Indicates when preset 2 is called Lit: Call done Blinking: Selecting
	Preset 3 Indicator: Indicates when preset 3 is called Lit: Call done Blinking: Selecting
	Preset 4 Indicator: Indicates when preset 4 is called Lit: Call done Blinking: Selecting
	Preset 5 Indicator: Indicates when preset 5 is called Lit: Call done Blinking: Selecting
	Preset 6 Indicator: Indicates when preset 6 is called Lit: Call done Blinking: Selecting
	Preset 7 Indicator: Indicates when preset 7 is called Lit: Call done Blinking: Selecting
	Preset 8 Indicator: Indicates when preset 8 is called Lit: Call done Blinking: Selecting
	REC Indicator: Indicates when recording Blinking: Recording
	SFX 1 Indicator: Indicates when SFX 1 is playing back Blinks: Playing back SFX 1
	SFX 2 Indicator: Indicates when SFX 2 is playing back Blinks: Playing back SFX 2
SFX 3 Indicator: Indicates when SFX 3 is playing back Blinks: Playing back SFX 3	

Interpretation Settings ([Interpretation Settings])

Item name		Description and setting values (default settings are shown in bold)
Interpretation Settings		
Interpretation Mode	Ⓟ	2 Languages , 3 Languages
Easy Mode	Ⓟ	Automatically toggles the voice on the floor with the voice of the interpreter. When [On] is set, for example, the voice on the floor is automatically output to language group 1 by putting INTs that are outputting an interpreter's voice to language group 1 on All Talk OFF. On, Off
Language Name		
Audio Group 1	Ⓟ	Set the Language Name for Audio Group 1. (Up to 15 characters) Language 1
Audio Group 2	Ⓟ	Set the Language Name for Audio Group 2. (Up to 15 characters) Language 2
Audio Group 3	Ⓟ	Set the Language Name for Audio Group 3. (Up to 15 characters) Language 3 NOTICE • Displayed only when "3 Languages" is selected in Interpretation Mode.
Interlock Mode	Ⓟ	Set Interlock Mode for interpretation units with the same settings. No Interlock , Interlock, Combine
INT Unit Settings (Max. 6 units)		
Connected INT Units		Display setting information of all INTs connected to the system. You can check and change settings.
LED		Check that the INT LED lights up. The rear LED on the INT, ring LED on the ATUC-M, and (talk) LED blink while the corresponding icon on the screen is lit.
Serial#		Displays the serial number.
Interpretation Languages	Ⓟ	Select the pattern for the languages to be interpreted. The language name selected from the selection list appears in [Language Name]. Additionally, patterns and the number of languages depend on the setting values of [Interpretation Mode]. If the Interpretation Mode is 2 Languages: 1: Language 1 ↔ 2: Language 2 , 1: Language 1 → 2: Language 2, 2: Language 2 → 1: Language 1 If the Interpretation Mode is 3 Languages: 1: Language 1 ↔ 2: Language 2 , 1: Language 1 ↔ 3: Language 3, 2: Language 2 ↔ 3: Language 3, 1: Language 1 → 2: Language 2, 2: Language 2 → 1: Language 1, 1: Language 1 → 3: Language 3, 3: Language 3 → 1: Language 1, 2: Language 2 → 3: Language 3, 3: Language 3 → 2: Language 2
Operations of the INT Unit Settings (*1)		

*1: About Operations of the INT Unit Settings

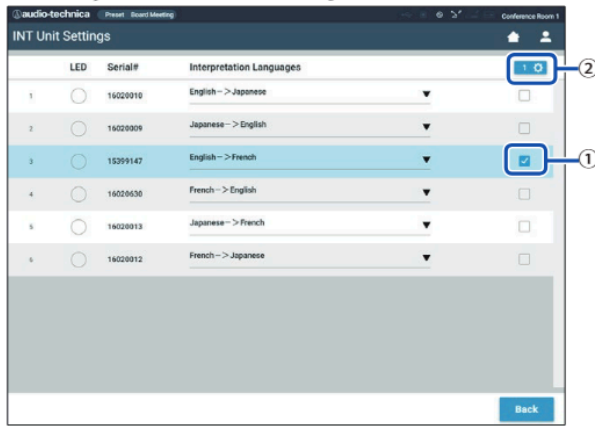

1 Click ① the INT(s) for which you want to change the settings.

A check mark appears in the checkbox.

You can also select multiple INTs and simultaneously change settings of the selected INTs.

2 Click ② to display the drop-down list and proceed to the following operations.

 • The number shown on ② indicates the number of the currently selected INTs.

Edit Detail Settings:

Configure the detailed settings of the INT(s) you selected (refer to the table below on detailed settings for INTs [INT Unit Detail Settings]). When multiple INTs are selected, setting items for which the current values differ among the INTs are grayed out.

- If items remain grayed out: Setting values of each INT are retained.
- If grayed out items become selectable after operation: Setting values of all selected INTs will be changed to the displayed values.

Select all:

Selects all INTs.

Deselect all:





Deselects all INTs.

Delete:

Deletes the selected INT(s) from the list. Only INT(s) that have been disconnected can be deleted.

-  • Depending on the INT selection state, some items above may not appear.
- There is no function to copy the settings of an INT to other INTs.

INT Unit Detail Settings ([INT Unit Detail Settings])

Item name	Description and setting values (default settings are shown in bold)	
Microphone	Configure microphone-related settings for the INT(s).	
Level Meter	Displays the level with a level meter.	
Input Gain		Set the microphone input gain. -20 to +20dB (0dB)
AGC		Enable/disable AGC (Automatic Gain Control). On, Off
EQ Library		Set an EQ pattern to be applied to the microphone input. Flat, Neutral Male, Neutral Female, Clear Male, Clear Female, Warm Male, Warm Female, AT ES Series, AT UniPoint, (IP Remote*) * [IP Remote] appears when the equalizer is adjusted from [IP Control Settings]. [IP Remote] cannot be selected from the drop-down list.
Phantom Power		Enable/disable the phantom power supply to the microphone. On, Off

Recording Settings ([Recorder])

NOTICE • Recording settings can be configured only when recording stops.

Item name		Description and setting values (default settings are shown in bold)
USB Recorder Settings		
Record File Format CU Rec Format	P	Select the conference recording format. WAV , MP3
Recording Quality	P	Set the bit rates for recording speech in MP3 format. 64, 128, 192, 256, 320 kbps
Number of Recording Channels (WAV) CU No.of Rec CH		Set the number of recording audio channels when the recording format is WAV. 1 to 4
Number of Recording Channels (MP3) CU No.of Rec CH		Set the number of recording audio channels when the recording format is MP3. 1 to 2
Recording Source Track1, Track2, Track3, Track4 CU Rec Source CH1-CH4	P	Set the recording source for each channel. Floor , Group 0, Group 1, Group 2, Group 3 , Language 1, Language 2, Language 3, Remote Lang. 1, Remote Lang. 2, Mic/Line 1, Mic/Line 2, Mic/Line 1&2 Mix
Auto Track	P	Split audio files by the specified time while recording or disable this function. Off , 15 min, 30 min, 1 hour, 2 hours
Rec Filename Prefix CU Filename Prefix	P	Specify prefix for recorded audio files. Up to 30 characters can be used. (Some characters cannot be used (▶ page 23). The default setting is atuc-50 .)

Accessing your presets ([Presets])

Recall, save, import/export presets.

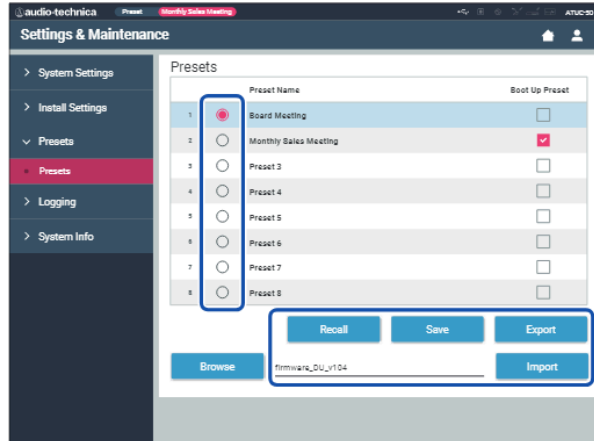

- 1 Click on the right side of the preset number you want to select.

will light red and the field of the selected preset will be highlighted in light blue.

- 2 Click the operation you want to perform.

The selected operation will be executed.

Recall (*Recall Presets*):

Sets the selected preset as the current setting.

Save (*Save Presets*):

Saves the current setting to the selected preset number.

The setting items with “**P**” in the table are included in the preset.

Export (*Export Presets*):

Exports the preset data to an external device. From the pop-up window, select the folder where you want to export the data.

Import (*Import Presets*):

Imports the preset data that was exported to an external device. From the pop-up window, select the preset data file you want to import.



- To edit the preset name, click the name. You can use up to 30 characters.
- If you want to do settings to call a specific preset while the system is starting, select that preset's number.

Log management ([Logging])

Configure the system log settings. You can also download the log file.

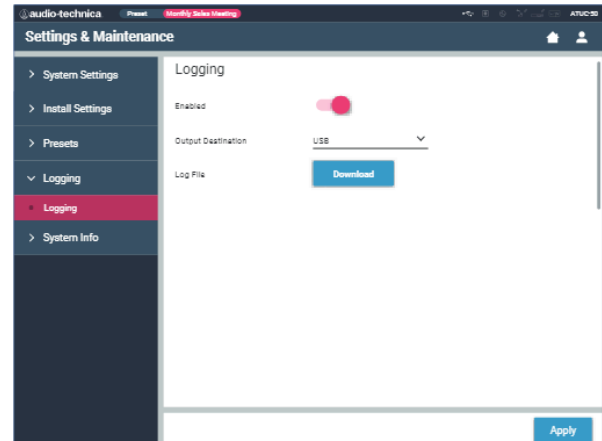

Enabled (*Logging*):

Set whether to save the system log. (On, Off)

Output Destination (*Destination*):

Set whether to export the log file to a USB device (mass storage device). (Internal, USB)

Log File:

Select the download destination and download the log file to the specified destination.

Displaying the system information ([System Info])

Display the system information such as the firmware version, various network setting statuses, and unit serial numbers.

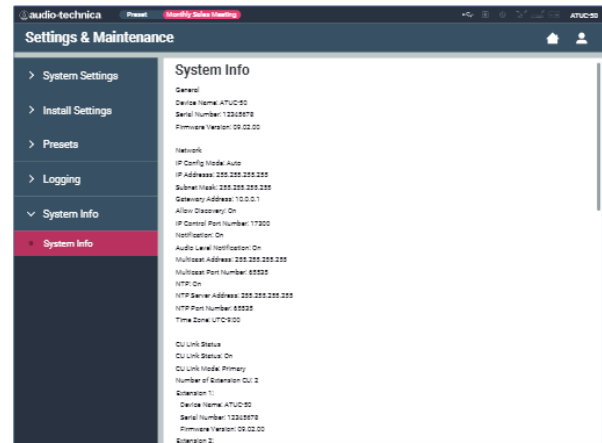

1 Preparing for conferences ([Setup Conference])

To handle many different types of conferences using an ATUC-50 system, it is recommended to preset multiple types of conference settings. Basic conference preparation can be carried out simply by recalling the preset that best suits an upcoming conference.

Up to 8 conference settings can be preset.

You can also change settings saved on the recalled preset to suit the upcoming conference.

Prepare for the upcoming conference in 3 steps by utilizing the preset function.

1 Recalling the preset ([Recall Preset])

The [Recall Preset] screen will appear if you click [Setup Conference] on the Home screen (▶ page 42).

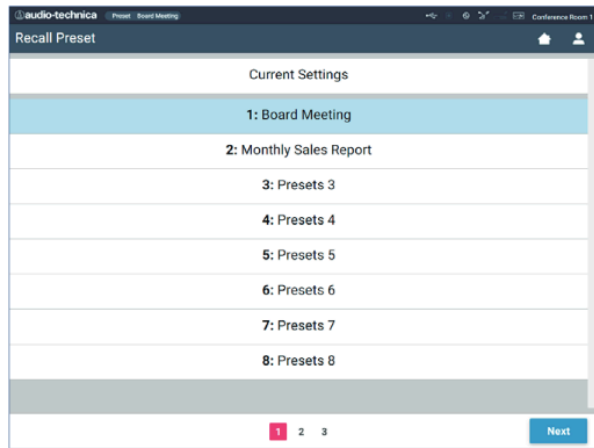

For starting a conference using the most recently used conference setting (Current Settings) or one of the preset settings, follow the procedure below to display the [Conference Manager] screen.

- 1 On the [Recall Preset] screen, select [Current Settings] or your desired preset and then click [Next].

 • To configure settings based on the current setting, select [Current Settings].

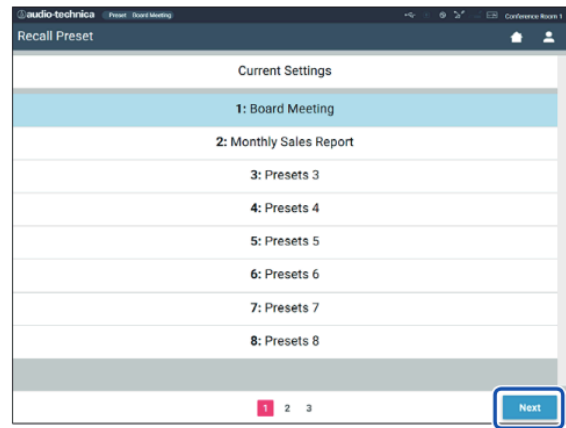

Recalls the preset and then displays the [Conference Settings] screen.

2 Changing the conference settings ([Conference Settings])

- 1 Change the settings as necessary and then click [Next].

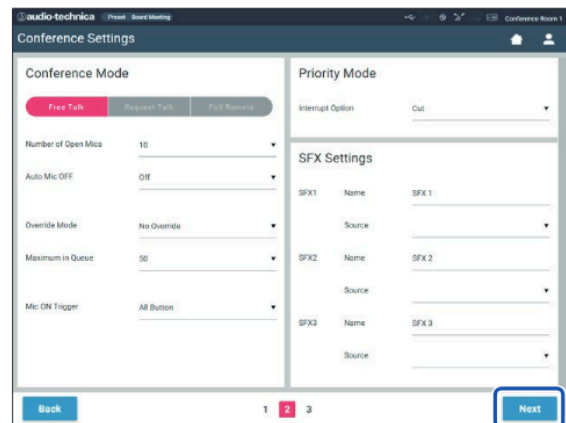

Saves the settings and displays the [DU/IU Settings] screen.

3 Adjusting the DU/IU settings ([DU/IU Settings], [DU/IU Detail Settings])

Configure DU/IU settings ([DU/IU Settings]) and DU/IU detail settings ([DU/IU Detail Settings]).

1 Change the settings as necessary.

To configure detail settings:

Proceed to step 2.

To finish settings without configuring detail settings:

Click [Next], then click [Done].

LED	Priority	Delegate Name	Audio Group	Color
<input type="checkbox"/>	☆	Dong Wang	<input checked="" type="checkbox"/>	<input type="checkbox"/>
<input type="checkbox"/>	☆	Cal Zhang	<input checked="" type="checkbox"/>	<input type="checkbox"/>
<input type="checkbox"/>	☆	Jing Li	<input checked="" type="checkbox"/>	<input type="checkbox"/>
<input type="checkbox"/>	★	Kohel Matsuda	<input checked="" type="checkbox"/>	<input type="checkbox"/>
<input checked="" type="checkbox"/>	☆	Santiago	<input type="checkbox"/>	<input type="checkbox"/>
<input type="checkbox"/>	☆	Linh Thi Nguyen	<input checked="" type="checkbox"/>	<input type="checkbox"/>
<input type="checkbox"/>	☆	Lucia Garcia	<input checked="" type="checkbox"/>	<input type="checkbox"/>
<input type="checkbox"/>	★	Emma Smith	<input checked="" type="checkbox"/>	<input type="checkbox"/>
<input type="checkbox"/>	☆	Ben Muller	<input type="checkbox"/>	<input checked="" type="checkbox"/>
<input type="checkbox"/>	★	Alexander Brimov	<input type="checkbox"/>	<input checked="" type="checkbox"/>
<input type="checkbox"/>	★	Raj Kumar	<input checked="" type="checkbox"/>	<input checked="" type="checkbox"/>
<input type="checkbox"/>	★	Lee Kim	<input checked="" type="checkbox"/>	<input type="checkbox"/>
<input type="checkbox"/>	☆	Miguel Silva	<input checked="" type="checkbox"/>	<input type="checkbox"/>

- For details on each setting item, refer to the [DU/IU Settings] item table (page 53).

2 Click ① of the DU/IU(s) for which you want to change the settings, to enter a ✓ mark.

- From the drop-down list ②, you can select/unselect all DU/IUs.
- The number shown on ② indicates the number of the currently selected DU/IUs.
- ① and ② will not appear if the currently logged in Operator is not permitted to access these settings.

3 From the drop-down list ②, click [Edit Detail Settings].

Displays the [DU/IU Detail Settings] screen and enables you to configure DU/IU detail settings.

4 Configure DU/IU detail settings and click [Apply] to apply the changes.

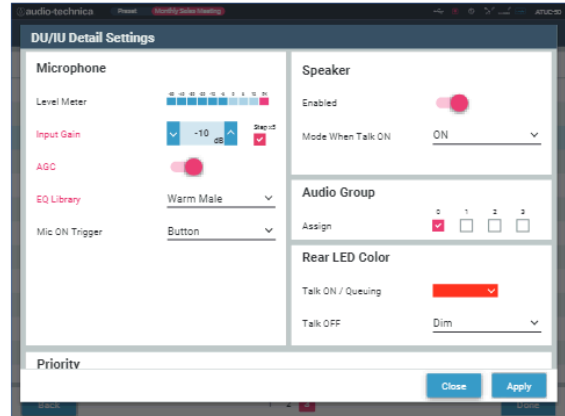

Returns to the [DU/IU Settings] screen.

- For details on each setting item, refer to the [DU/IU Detail Settings] item table (page 55).
- When multiple DU/IUs are selected, setting items for which the current values differ among the DU/IUs will be grayed out. These setting items cannot be adjusted.
- The [Phantom Power] setting for DU/IUs can be configured from [Settings & Maintenance] → [Install Settings] → [DU/IU] → [Individual DU/IU Settings] → [Connected DU/IUs] → [Edit Detail Settings] → [DU/IU Detail Settings] (page 55).

5 Click [Done] on the bottom right of the screen.

The [Conference Manager] screen under [Start Conference] appears (page 64) indicating that the system is ready to start the conference.

Operating and controlling conferences ([Start Conference])

The [Start Conference] screen is displayed by clicking [Start Conference] (page 42) or after finishing conference settings from [Setup Conference].

Operate and control a conference underway. You can also change detailed settings of the conference underway.

Using the tabs on the upper side of the screen, conference mode can be switched between the following 3 modes.

1 [Conference Manager]

- Settings and management for attendees
- Utterance control
- DU/IU detailed settings

2 [Audio Control]

- Speech output level adjustment
- Conference recording operations
- Audio playback operation such as chime

3 [Conference Settings]

- Conference mode settings and various detailed settings
- Audio playback settings such as chime

- Perform the recording operations. See "Recording operations" (page 65).
- Click repeatedly to adjust the volume level. Click the up/down buttons to adjust the volume level for OUTPUT 1. By ticking the checkbox ⑨, the level can be adjusted in [Step x10] increments.

*1 From the [Conference Manager] screen, the [Priority] and [Color] settings are not configurable.

*2 When the Operator access authority is set to [Limited], these items are not displayed.

- The operation and setting items other than ① to ⑨ described above are the same as the items on the [DU/IU Settings] screen (page 63).

When in Request Talk Mode:

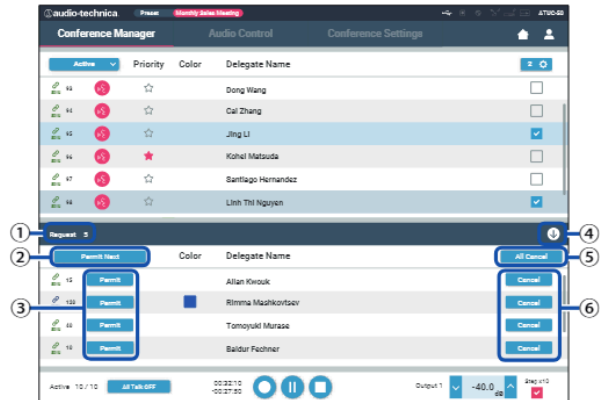

In Request Talk Mode, in addition to the DU/IU list, the list of DUs requesting to talk can also be displayed.

- The number of DUs requesting to talk
- Permits the DU on the top of the list to talk
- Permits the corresponding DU to talk
- Opens/closes the request list
- Cancels all requests to talk
- Cancels request to talk from the corresponding DU

1 Operating conferences ([Conference Manager])

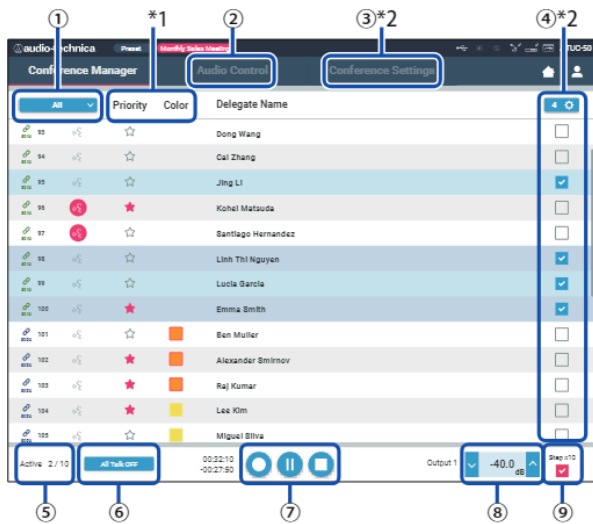



- Select [All] to display all connected DU/IUs or [Active] to display currently talking speakers.
- Displays the [Audio Control] screen (page 65).
- Displays the [Conference Settings] screen (page 65).
- Displays the [DU/IU Detail Settings] screen (page 63).
- Indicates the number of speakers currently talking. The numerator is the number of people speaking and the denominator is the maximum number of people that can speak at one time.
- Cuts short all currently talking DU/IU users.



Recording operations:

Recording operations such as starting and stopping recording can be performed either on the [Conference Manager] screen or on the [Audio Control] screen (▶ page 65). On the [Audio Control] screen, you can both configure the advanced audio-related settings and perform audio operations.

Perform the recording operations using the following 3 buttons available at the bottom of the [Conference Manager] screen.

-  Rec button
Starts recording.
-  Pause button
Pauses recording.
-  Stop button
Stops recording.

About button colors:

-  Buttons in this color cannot be operated.
-  Buttons in this color can be operated.
-  Buttons in this color are currently being operated.
If you press a button, the button turns this color.

2 Configuring the advanced audio-related settings and performing audio operations ([Audio Control])

Click the [Audio Control] tab to proceed to the [Audio Control] screen.

You can perform the recording operations and configure the advanced audio-related settings on one screen.

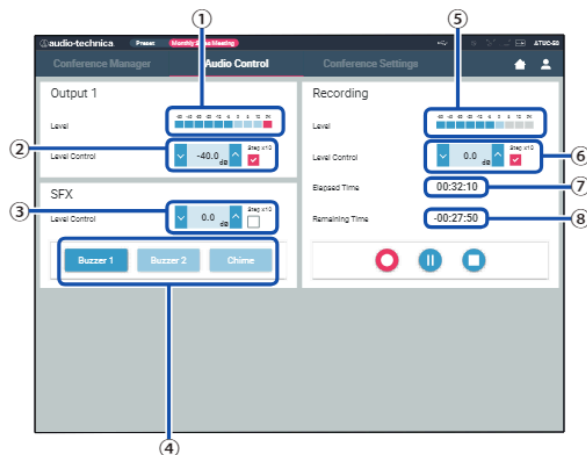

- ① This is the OUTPUT 1 level meter and indicates the level of audio output from OUTPUT 1.
- ② Adjust the OUTPUT 1 level. Be sure not to light up the red indicator (PK) of the level meter ① while adjusting the level.
- ③ Adjust the SFX playback level while checking the level with the level meter ① etc.
- ④ These are SFX operation buttons. Audio files set from [Conference Settings] are played (▶ page 62). Pressing an SFX

button plays the corresponding audio file. Click the button again to stop playing.

- ⑤ This is the recording level meter and indicates the level of the voice currently being recorded. (Even in recording pause mode, the voice level meter activates when detecting voices.)
- ⑥ Adjust the recording level. Be sure not to light up the red indicator (PK) of the recording level meter ⑤ while adjusting the level.
- ⑦ This is the elapsed recording time.
- ⑧ This is the available recording time.

 • The operation and setting items other than ① to ⑧ described above are the same as the items on the [Conference Manager] screen (▶ page 64).

3 Configuring conference settings ([Conference Settings])

Click the [Conference Settings] tab to display the [Conference Settings] screen.

According to the conference control and operation methods, select conference mode and configure detailed settings.

The operations and settings are the same as [Settings & Maintenance] → [Install Settings] → [Conference] (▶ page 52).

Information

Troubleshooting

If a problem should arise, first check the following:

1. Check your connections.
2. Verify that the system is being operated as described in this instruction manual.
3. Check that the external devices are operating properly. Check the operation while the devices are not connected to the CU.
4. Restart your network devices.

If any unit in the system is not operating properly, check the items listed in the table below.

If the symptom is not covered on the checklist below, contact our sales representative.

When you contact us, you may be asked the firmware version. Please check the firmware version by following the procedure below.

To check from Web Remote:

[Settings & Maintenance] → [System Settings] → [Utilities]

or

[Settings & Maintenance] → [System Info]

To check on the CU display:

Set → Log in as *Administrator* or *Operator* → *System Info*

ATUC-50CU

Symptom	Cause/Solution	Page
Cannot turn on the power.	Check that the AC power cord is connected properly.	page 37
The connected microphone does not work.	Check the connection of the microphone.	page 11
	Check and adjust the MIC/LINE 1/2 settings.	page 49
	To check from Web Remote: [Settings & Maintenance] → [Install Settings] → [CU Audio] → [Input Settings] To check on the CU display: Set → Log in as <i>Administrator</i> or <i>Operator</i> → <i>Audio Setting</i>	page 10
The sound from the connected speaker is distorted or cannot be heard.	Check the connections of all devices.	page 11
	Plug the connection cables all the way in.	-
	Check that the inputs and outputs of all devices are connected properly.	page 11
	Check that terminal pin assignments (Hot/Cold/GND, etc.) are correct.	page 11
	Check that the cables are not damaged.	-
Cannot record sound.	Check and adjust the setting of the connected amplifier.	-
	Check the remaining memory on the USB device (mass storage device).	-
	Reconnect the USB device (mass storage device) or try with a different USB device (mass storage device).	-
Although recording has performed properly, when playing the recorded files using a device such as a computer, no sound is heard.	Check that the recording channel set from [Rec source] is correct.	page 60
	To check from Web Remote: [Settings & Maintenance] → [Install Settings] → [Recorder] → [USB Recorder Settings] To check on the CU display: Set → Log in as <i>Administrator</i> or <i>Operator</i> → <i>Recorder Setting</i>	page 10

Symptom	Cause/Solution	Page
You forget the password.	<p>Follow the procedure below to reset the password.</p> <p>① Display the HOME screen of the CU display and then while pressing the BACK button on the CU front panel, rotate the jog dial clockwise until it clicks 3 times.</p> <p>② While pressing the BACK button, rotate the jog dial counterclockwise until it clicks 3 times.</p> <p>③ While pressing the BACK button, press the ENTER button.</p>	page 9

ATUC-50DU/INT

Symptom	Cause/Solution	Page
Cannot turn on the power.	Check the connection to the CU or other DUs/INTs.	pages 26, 27
The $\mu\zeta$ (talk) button does not function.	<p>Depending on the conference mode or setting, the $\mu\zeta$ (talk) button may not function. Check the conference mode settings.</p> <p>To check from Web Remote: [Settings & Maintenance] → [Install Settings] → [Conference] → [Conference Mode]</p> <p>To check on the CU display: <i>Set</i> → Log in as <i>Administrator</i> or <i>Operator</i> → <i>Conference Mode</i></p>	<p>page 52</p> <p>page 10</p>
	<p>The settings of the interpretation unit(s) may cause speech to be output incorrectly, even if the talk button is pressed to speak. Check the settings of the interpretation unit(s).</p> <p>To check from Web Remote: [Settings & Maintenance] → [Install Settings] → [Interpretation] → [Interpretation Settings] → [Interpretation Mode]</p> <p>and</p> <p>[Settings & Maintenance] → [Install Settings] → [Interpretation] → [INT Unit Settings] → [Interpretation Languages]</p>	page 58
No sound is output from the headphone jack.	Insert the headphone plug all the way in.	-
	Raise the volume with the + button.	pages 12, 13
	Use the monitor channel selection button(s) of the DU/INT to confirm that you can monitor speech from the channel you want.	pages 12, 13
No sound is output from the built-in speaker.	Check the connection of the DUs.	page 27
	Plug the Ethernet cable all the way in.	-
	Check that the cables are not damaged.	-
	From [Settings & Maintenance] → [Install Settings] → [DU/IU] → [DU/IU Detail Settings], check that the [Speaker] setting is set to [Enabled].	page 55
	<p>Adjust the speaker level.</p> <p>To check from Web Remote: [Settings & Maintenance] → [Install Settings] → [DU/IU] → [Global DU/IU Settings] → [Speaker Level]</p> <p>To check on the CU display: <i>Set</i> → Log in as <i>Administrator</i> or <i>Operator</i> → <i>Audio Setting</i> → <i>DU SP Output Lvl</i></p>	<p>page 53</p> <p>page 10</p>
Speech is not output from the built-in speaker of the INTs.	-	

Symptom	Cause/Solution	Page
The ATUC-M does not operate.	Insert the ATUC-M connector into the microphone jack on the DU/INT until a clicking sound is heard.	page 37
	For DUs: From [Settings & Maintenance] → [Install Settings] → [DU/IU] → [DU/IU Detail Settings], check the setting of [Microphone].	page 55
	For the INTs: From [Settings & Maintenance] → [Install Settings] → [Interpretation] → [INT Unit Settings] → [INT Unit Detail Settings] check the setting of [Microphone]. <ul style="list-style-type: none"> • Check that [Phantom Power] is not set to [Off]. • Check that [Input Gain] is not too low. 	page 59
If you read the preset, the settings changed from the last settings.	Check that the preset data is correct.	page 61
	Check that the number and topology of the DUs/INTs have not changed since the last time.	page 61

ATUC-50IU

Symptom	Cause/Solution	Page
Cannot turn on the power.	Check the connection to the CU or other DUs/INTs.	pages 26, 27

ATLK-EXT165

Symptom	Cause/Solution	Page
Cannot turn on the power.	Check that the AC power cord is connected properly.	page 37

Web Remote

Symptom	Cause/Solution	Page
"Locate" does not recognize the CU that you want to control via Web Remote.	Check the connections of units including the CU and the control device such as a computer.	page 38
	Check that the CU and the control device such as a computer are connected to the same network.	-
The CU you want to control via Web Remote is grayed out on "Locate."	When multiple CUs are cascaded and CU LINK is functioning, the CU(s) is grayed out on "Locate" while it is set to [Extension] from [General] → [CU Link Settings] → [Primary/Extension]. Check the setting again.	page 44
Cannot start Web Remote on your control device such as a tablet or iPad.	Check that the control device is connected to a correct access point.	-
	Check that the CU and the control device such as a tablet or iPad are connected to the same network.	-
You forget the password.	Follow the procedure below to reset the password. <ol style="list-style-type: none"> ① Display the HOME screen of the CU display and then while pressing down the BACK button on the CU front panel, rotate the jog dial clockwise until it clicks 3 times. ② While pressing down the BACK button, rotate the jog dial counterclockwise until it clicks 3 times. ③ While pressing the BACK button, press the ENTER button. 	page 9

Error messages

- Error messages displayed on the Web Remote screen and CU displays are as follows.
- The states of the CU LED error indicators are described together with the CU display error messages.
- If the same error persists even after the following remedies are taken, or when the unit(s) requires repair or parts replacement, contact our sales representative.

	Web Remote	CU display (LED indicators)	State/remedies
1	Resume Data Error	Resume Data Err	Failed to read the resume information. <ul style="list-style-type: none"> • The unit was started up using the second from the last setting or default setting. Although there is no functional limitation, be sure to restart the unit to check that the same error does not occur again.
2	Preset Data Error	Pst Data Err	Failed to read the preset data. <ul style="list-style-type: none"> • This error may occur when you recall the default preset or the preset which you successfully recalled last time. Although there is no functional limitation, be sure to restart the unit to check that the same error does not occur again.
3	DU Power Error	DU Power Err (DU CHAIN: blinks green)	An error occurred when power was supplied to the DU. <ul style="list-style-type: none"> • Voltage may fall at the 48V output. ① After disconnecting all DUs from the CU, restart the CU. If the same error occurs again, the CU requires repair. ② If the same error does not occur again in ① but the error occurs again after connecting the DUs, there may be a damaged cable or DU. Identify the damaged cable or DU for replacement or repair.
4	DU Communication Error	DU Comm Err (DU CHAIN: blinks green)	DU individual settings cannot be configured. <ul style="list-style-type: none"> • Check that there is no DU connection error.
5	DU Ring to Daisy	DU Ring to Daisy (DU CHAIN: blinks green)	The DU topology has been changed (from ring to daisy). <ul style="list-style-type: none"> • If this error occurs even though you did not change the DU connection, check that there is no DU connection error.
6	DU Daisy to Ring	DU Daisy to Ring (DU CHAIN: blinks green)	The DU topology has been changed (from daisy to ring). <ul style="list-style-type: none"> • If this error occurs even though you did not change the DU connection, check that there is no DU connection error.
7	Number of DU Decreased	DU Number Decrease (DU CHAIN: blinks green)	The number of connected DUs decreased. <ul style="list-style-type: none"> • If this error occurs even though you did not change the DU connection, check that there is no DU connection error.
8	DU Exceeds 100 Units	DU Exceeds 100pcs (DU CHAIN: blinks green)	More than 100 DUs are connected to the DU CHAIN A/B/C/D terminals in total. <ul style="list-style-type: none"> • Connect 100 DUs or less to each CU.
9	INT Unit Exceeds 6 Units	INT Exceeds 6pcs (DU CHAIN: blinks green)	More than 6 INTs are connected to the DU CHAIN A/B/C/D terminals in total. <ul style="list-style-type: none"> • Connect 6 INTs or less to CU.
10	DU A/B: Exceeds 50 Units	DU A/B Exceeds 50pcs (DU CHAIN: blinks green)	More than 50 DUs are connected to the DU CHAIN A/B terminals in total. <ul style="list-style-type: none"> • Connect 50 DUs or less to the DU CHAIN A/B terminals in total.
11	DU C/D: Exceeds 50 Units	DU C/D Exceeds 50pcs (DU CHAIN: blinks green)	More than 50 DUs are connected to the DU CHAIN C/D terminals in total. <ul style="list-style-type: none"> • Connect 50 DUs or less to the DU CHAIN C/D terminals in total.
12	CU Communication Error	CU Comm Err (CU LINK: blinks green)	A communication error occurred between the CUs. <ul style="list-style-type: none"> • Check that there is no CU connection error.
13	CU Link OFF	CU Link OFF (CU LINK: blinks green)	CU Link is cancelled. <ul style="list-style-type: none"> • If this error occurs unexpectedly, check that there is no CU connection error.
14	Network Communication Error	Network Comm Err (REMOTE: blinks green)	(1) A network communication error occurred. (2) An IP command communication error occurred. <ul style="list-style-type: none"> • Check that there is no network connection error.

	Web Remote	CU display (LED indicators)	State/remedies
15	USB Access Error	USB Access Err	An error occurred when accessing the USB device (mass storage device). <ul style="list-style-type: none"> • Check that the USB device (mass storage device) has no problems. • Check that the same error does not occur with another USB device (mass storage device).
16	USB Format Error	USB Format Err	There is a problem with the USB device (mass storage device). <ul style="list-style-type: none"> • Check the format of the USB device (mass storage device). • Use a USB device (mass storage device) formatted with FAT16 or FAT32.
17	Failed	Failed	(1) The setting cannot be configured due to some system errors. <ul style="list-style-type: none"> • Try to configure the setting again and check whether the same error occurs again. (2) Playback operation cannot be performed. <ul style="list-style-type: none"> • Check that the USB device (mass storage device) is connected properly. • Check that the file you want to play is in the USB device (mass storage device). • Check that the format of the file you want to play is correct. (You can check by, for example, playing the file with another playback device.) (3) Recording operation cannot be performed. <ul style="list-style-type: none"> • Check that the USB device (mass storage device) is inserted in the CU. • Check that write protection is disabled on the USB device (mass storage device). • Check the space available on the USB device (mass storage device). • Check that the USB device (mass storage device) has no problems. • Check that the same error does not occur with another USB device (mass storage device).
18	File Export Failed		(4) The preset data cannot be exported. <ul style="list-style-type: none"> • Check that the USB device (mass storage device) has no problems. • Check that the same error does not occur with another USB device (mass storage device).
19	File Import Failed		(5) The preset data cannot be imported. <ul style="list-style-type: none"> • Check that the USB device (mass storage device) has no problems. • Check that the same error does not occur with another USB device (mass storage device).
20	USB Write Error	USB Write Err	The data log cannot be saved onto the USB device (mass storage device). <ul style="list-style-type: none"> • Check that the USB device (mass storage device) is inserted to the CU. • Check that write protection is disabled on the USB device (mass storage device). • Check the space available on the USB device (mass storage device). • Check that the USB device (mass storage device) has no problems. • Check that the same error does not occur with another USB device (mass storage device).
21	Failed. Please turn power OFF.	CU FW Update Err Please Turn Pwr OFF	An error occurred during the CU firmware update. <ul style="list-style-type: none"> • Turn off the power and restart the CU.
22	Failed. Please turn power OFF.	DU FW Update Err Please Turn Pwr OFF	An error occurred during the DU firmware update. <ul style="list-style-type: none"> • Turn off the power and restart the CU. (When the update cannot be performed for the 1st DU, or an error occurs during the update process and the update cannot be continued.)
23	Failed. Please turn power OFF.	INT FW Update Err Please Turn Pwr OFF	An error occurred during the INT unit firmware update. <ul style="list-style-type: none"> • Turn off the power and restart the CU. (When the update cannot be performed for the 1st INT, or an error occurs during the update process and the update cannot be continued.)

	Web Remote	CU display (LED indicators)	State/remedies
24	Failed. Please turn power OFF.	IU FW Update Err Please Turn Pwr OFF	An error occurred during the IU firmware update. • Turn off the power and restart the CU. (When the update cannot be performed for the 1st IU, or an error occurs during the update process and the update cannot be continued.)
25	Completed except serial numbers below. Please turn power OFF. XXXXXXXXXX XXXXXXXXXX (Displays a list of 8-digit serial numbers of DUs for which the update cannot be performed.)	Part of DU Failed Please Turn Pwr OFF	The DU firmware update has been completed but the update cannot be performed for some DUs. ①The serial numbers of DUs for which the update cannot be performed will be listed on the pop-up screen. Write them down. ②Turn off the power. ③Disconnect the DUs with the serial numbers you wrote down. ④Perform emergency update for the DUs you disconnected in step ③. For details on how to perform the emergency update, contact our sales representative.
26	Completed except serial numbers below. Please turn power OFF. XXXXXXXXXX XXXXXXXXXX (Displays a list of 8-digit serial numbers of INTs for which the update cannot be performed.)	Part of INT Failed Please Turn Pwr OFF	The INT unit firmware update has been completed but the update cannot be performed for some INTs. ①The serial numbers of INTs for which the update cannot be performed will be listed on the pop-up screen. Write them down. ②Turn off the power. ③Disconnect the INTs with the serial numbers you wrote down. ④Perform emergency update for the INTs you disconnected in step ③. For details on how to perform the emergency update, contact our sales representative.
27	Completed except serial numbers below. Please turn power OFF. XXXXXXXXXX XXXXXXXXXX (Displays a list of 8-digit serial numbers of IUs for which the update cannot be performed.)	Part of IU Failed Please Turn Pwr OFF	The IU firmware update has been completed but the update cannot be performed for some IUs. ①The serial numbers of IUs for which the update cannot be performed will be listed on the pop-up screen. Write them down. ②Turn off the power. ③Disconnect the IUs with the serial numbers you wrote down. ④Perform emergency update for the IUs you disconnected in step ③. For details on how to perform the emergency update, contact our sales representative.
28	Data acquisition error.	Data Acquisition Err	Failed to acquire data through operation via Web Remote or the CU display. • Perform the operation again and check whether the same error occurs.
29	Unable to Set	Unable to Set	(1) Unusable characters are contained in the string of letters you have entered. • Delete unusable characters. (2) The change cannot be applied because the entered values are out of the permitted range or the change is not allowed. • Enter values within the permitted range. • Check that the unit is in a state where changes are allowed and then perform the operation again and check whether the same error occurs.
		Can't.ReducePriority	(3) The setting of [Number of Open Mics] (NOM) cannot be changed due to the current number of priority DUs. • Set a different number for [Number of Open Mics] (NOM) or change the number of priority DUs.
30	All DUs will be turned off to apply the changes. Do you wish to proceed?	Turn OFF All DU?	(4) Since recording, recording pause, or file reading process is under way, any recording-related settings cannot be configured. • Stop recording and then perform the operation again. (5) You must turn off the microphones for all of the DUs in order to change the settings. • Selecting [Yes] forces the microphones for all of the DUs off and changes the settings.
31	Unable to control.	Unable to Ctrl	(1) Since recording, recording pause, or file reading process is under way, the operation cannot be performed. (2) Due to other reasons, the operation cannot be performed. (Operations except changing settings cannot be performed.) • Stop recording and then perform the operation again.

	Web Remote	CU display (LED indicators)	State/remedies
32	Number of priority units exceeds maximum. Reduced priority channels.	-	The number of DUs which are set as priority DUs exceeded the limit due to CU Link. Decrease the number of priority DUs. (Deactivate the priority setting for some DUs.) • Check the priority DUs and change the setting as necessary.
33	Unable to set. Number of priority channels exceeds maximum.	-	The maximum number of DUs that can be designated as priority DU is 1 unit less than the specified value for [Number of Open Mics] (<i>NOM</i>). No more DUs can be designated as a priority DU. • Change the setting value for the <i>NOM</i> or DU priority setting.
34	Recording Failed	-	A recording function error occurs such as a recording error not due to recording operations via Web Remote. • Check that no error occurs during recording on the CU. If an error occurs, solve the problem according to the error.
35	-	Boot Error XXX	An error occurred while booting the CU. (XXX indicate an error code.) • Restart the CU and check whether the same error occurs. If the same error occurs again, the CU requires repair.
36	-	Chg to FreeTalk Mode	Since a communication error occurred with the control device, the conference mode will be switched to Free Talk Mode where you do not need the control device. • Check that there is no network connection problem.
37	-	Forcible FW Update	Emergency update executes for the CU. • Follow the message displayed and do not turn off during the update.
38	-	Connect USB Device with FW Update File	Emergency update executes (for the CU or the DU). • Insert a USB control device (mass storage device) where the firmware is stored to the CU.

Specifications

ATUC-50CU specifications

General specifications

I/O Connectors	Inputs	Mic/Line×2, AUX (ST)×1, INTERPRETATION RETURN×2	
	Outputs	BAL.×4, UNBAL.×1	
	LINK/CHAIN	DU A/B terminals, CU A/B terminals (DU C/D terminals)	
Recording(*1)	Via USB storage device	1/2/3/4 track (WAV) (BWF standard) 1/2 track (MP3) (Original format)	
	MP3 bit rate	64kbps/128kbps/192kbps/256kbps/320kbps	
Playback(*1)	WAV	Data length	16bit, 24bit
		Sampling frequency	48kHz
	MP3(*2)	Bit rate	32-320kbps
		Sampling frequency	48kHz
	Maximum file size	2GB	
	Maximum number of files	30files	
Signal delays		MIC Input to Output: 1ms DU to CU: 1.2ms	
Frequency response		+1.0, -2.0dB 20Hz - 20kHz, refer to +4dBu output @1kHz.	
Dynamic range		110dB A-Weighted	
Signal to noise		90dB A-Weighted	
Headroom		20dB	
Equivalent input noise	Mic/Line 1-2	Less than -126dBu Rs=150ohm	
Residual noise		Less than -86dBu A-Weighted	
Total harmonic distortion		Less than 0.03% 1kHz unity	
Crosstalk @1kHz		Less than -80dB	
OLED display		20 × 2 Character type, Color: Yellow	
Phantom power		DC+48V	
Power requirement		AC 100V-240V 50/60Hz	
Power consumption		20W-175W (max.), Connecting 50 ATUC-50DUs is equivalent to 2.55A.	
Operation guaranteed temperature range		0-40°C	
Operation guaranteed humidity range		25-85%	
External dimensions (W × D × H)		482.6mm × 331.6mm × 44mm	
Net Weight		3.4kg	
Finish	Front panel	Black	
	Top & Rear	Black	
Included Accessories		AC power cord, Quick Setup Guide ×2, Euroblock connectors ×9, Warranty	

*1 Supported file systems: FAT16/FAT32

*2 Supported format: MPEG-1 Audio Layer-3.

Input/output specifications

Analog input specifications

Input Terminals	Gain	Load Impedance	Input Level			Connector	Balanced/ Unbalanced
			Minimum	Unity	Maximum		
MIC/LINE Input 1-2	Mic 15-59dB	5k ohm	-60dBu	-40dBu	-16dBu	Euroblock	Balanced
	Line 15-59dB	20k ohm	-40dBu	+4dBu*/ 0dBu	+24dBu*/ +20dBu	Euroblock	Balanced
AUX Input LR (Mono x2)	-	10k ohm	-	0dBV*/ -10dBV/ -20dBV	+20dBV*/ +10dBV/ 0dBV	RCA Pin	Unbalanced
INTERPRETATION RETURN 1-2	-	20k ohm	-	+4dBu*/ 0dBu	+24dBu*/ +20dBu	Euroblock	Balanced

* Default setting

Analog output specifications

Output Terminals	Load Impedance	Output Level			Connector	Balanced/ Unbalanced
		Minimum	Unity	Maximum		
BAL. (Balanced) Output 1-4	150ohm	-	+4dBu	+24dBu	RCA Pin	Balanced
UNBAL. (Unbalanced) Output 1	300ohm	-	0dBV	+20dBV	Euroblock	Unbalanced

Digital input/output specifications

Terminals	Format	Data length/Sampling Frequency	Audio	Connector
USB	USB	24bit/48kHz	Playback: MP3 or WAV/Record: MP3 or WAV	USB (A type)
DU CHAIN A/B (C/D)	Original format	24bit/48kHz	Floor, Return, Interpretation language, Active Mic	RJ-45
CU LINK A/B	Original format	24bit/48kHz	Floor, Return, Interpretation language, Active Mic	RJ-45

Control I/O specifications

Terminals	Format	Level	Connector
NETWORK	IEEE802.3	10BASE-T/100BASE-TX	RJ-45

ATUC-50DU/INT specifications

General specifications

I/O connectors	Inputs	Microphone jack×1
	Outputs	Headphone jack×1
	CHAIN	DU/CU connection terminals
Sampling frequency		24bit/48kHz
Frequency response		+1.0, -2.0dB 20Hz - 20kHz, refer to +4dBu output @1kHz.
Dynamic range		107dB A-Weighted
Signal to noise		87dB A-Weighted
Headroom		20dB
Equivalent input noise		Less than -121dBu Rs=150ohm
Total harmonic distortion		Less than 0.07% 1kHz unity
Phantom power		DC+24V
Power requirement		DC+48V
Power consumption		2.2W
Operation guaranteed temperature range		0-40°C
Operation guaranteed humidity range		25-85%
External dimensions (W × D × H)		135mm × 148.3mm × 84.2mm
Net Weight		570g (900g including the optional bottom weight)
Finish	Top panel	Gun metal
	Enclosure	Black
Included Accessories		Quick Setup Guide, Warranty

Input/output specifications

Analog input specifications

Input Terminals	Gain	Load Impedance	Input Level			Connector	Balanced/ Unbalanced
			Minimum	Nominal	Maximum		
MIC Input	7-47dB	5k ohm	-60dBu	-40dBu	-20dBu	XLR female	Balanced

Analog output specifications

Output Terminals	Load Impedance	Output Level			Connector
		Minimum	Nominal	Maximum	
Headphones	32ohm	-	1.5mW	15mW	φ3.5mm Stereo
Speaker	8ohm	-	50mW	100mW	-

Digital input/output specifications

Terminals	Format	Data length/Sampling Frequency	Audio	Connector
DU CHAIN A/B	Original format	24bit/48kHz	Floor, Return, Interpretation language, Active Mic	RJ-45

Control I/O specifications

Terminals	Format	Level	Connector
Option port	UART	+5V, TX, RX, GND	RJ-11

ATUC-50IU specifications

General specifications

I/O connector	Inputs	Euroblock connector: microphone input terminal × 1 set, operation input terminal × 6 sets, and general purpose input terminal (GPI) × 8 sets
	Outputs	Euroblock connector: speaker output terminal × 1 set, headphone output terminal × 1 set, status output terminal × 6 sets, power supply terminal × 1 set, general output terminals (GPO) × 8
	CHAIN	DU/CU connection terminals
Data length/Sampling frequency		24bit/48kHz
Frequency response		+1.0 - 2.0 dB, 20 Hz - 20 kHz (+4 dBu output at 1 kHz)
Dynamic range		106 dB, A-Weighted
S/N ratio		86 dB, A-Weighted
Headroom		20 dB
Noise equivalent input		Less than -125 dBu, $R_s = 150 \Omega$
Total harmonic distortion		Less than 0.07%, 1 kHz unity
Phantom Power		DC+48V
Power requirement		DC+48V
Power Consumption		3.4 W
Operation guaranteed temperature range		0 - 40°C
Operation guaranteed humidity range		25 - 85%
External dimensions (W × D × H)		116 mm × 173 mm × 25 mm
Weight		460g
Included Accessories		Quick Start Guide, Euroblock connectors × 13 (green × 3, black × 10), warranty

Input/output specifications

Analog input specifications

Input Terminals	Gain	Load Impedance	Input Level			Connector	Balanced/unbalanced
			Minimum value	Nominal value	Maximum value		
MIC Input	7 - 47 dB	4k ohm	-60 dBu	-40 dBu	-20 dBu	Euroblock	Balanced

Analog output specifications

Output Terminals	Load Impedance	Output Level			Connector
		Minimum value	Nominal value	Maximum value	
Headphones	32 ohm	-	1.5 mW	15 mW	Euroblock
Speaker	8 ohm	-	50 mW	100 mW	Euroblock

Digital input/output specifications

Terminals	Format	Data length/Sampling frequency	Audio	Connector
DU CHAIN A/B	Original format	24 bit/48 kHz	Floor, Return, Interpretation language, Active Mic	RJ-45

Control I/O specifications

Terminals	Connector
Operation input terminal	Euroblock
Status output terminal	Euroblock
General purpose input/output terminal	Euroblock

■ ATLK-EXT165 specifications

General specifications

I/O connector	LINK POWER STATUS	Euroblock connector (3 pins)
	CHAIN	DU/CU connector terminals (RJ-45 × 2)
Power supply		100 - 240 VAC, 50/60 Hz
Power Consumption		15 - 160 W (max.); 50 ATUC-50DUs is equivalent to 2.55 A
Operation guaranteed temperature range		0 - 40 °C
Operation guaranteed humidity range		25 - 85%
External dimensions (W × D × H)		217 mm × 326 mm × 41mm
Weight		2.2 kg
Included Accessories		Quick Start Guide, Euroblock connector × 1 (black), table mount, warranty

■ ATUC-M43H/58H specifications

	ATUC-M43H	ATUC-M58H
Type	Back electret type	
Directional characteristics	Hyper-cardioid	
Frequency characteristics	100-15,000Hz	
Sensitivity (0dB=1V/1Pa, 1kHz)	-40dB	
Maximum input sound pressure level (1kHz, THD1%)	134dB S.P.L.	
Signal-to-Noise ratio (1kHz, 1Pa)	64dB or more	
Output impedance	250ohms balanced	
Finish	Mat black baking paint finish	
External dimensions	18.9mm diameter×430mm	18.9mm diameter×580mm
Weight	Approx. 82g	Approx. 92g

