

# Quick Start Guide

for

## W20/X100/N100H/N10



**aurender**  
REFERENCE MUSIC SYSTEMS

# Table of Contents

What Is Required	3
STEP 1: DOWNLOAD THE AURENDER APP	4
STEP 2: CONNECT AURENDER TO YOUR LOCAL NETWORK	5
STEP 3: UPDATE AURENDER'S SYSTEM SOFTWARE TO THE LATEST VERSION	6
STEP 4: PREPARING MUSIC CONTENT	8
Loading music into the Aurender's internal drive using a Mac	8
Loading music into the Aurender's internal drive using a PC	10
STEP 5: PLAYING MUSIC	12
Important Notice Regarding the Power Off Procedure	13
Procedures To Factory Restore Your Aurender	14

# What Is Required:

## 1. Aurender Music Server

: W20/X100/N100H/N10

## 2. Apple iPad 2 or later

: iPad Air2 is recommended for its fast processing speed and 801.11ac wireless connection

## 3. Wireless router with at least 3 gigabit ports

: Apple Airport Extreme is recommended for its easy to setup, reliable and fast (801.11ac) operation, Gigabit ports router is recommended for faster music file transfer.  
Apple Airport Extreme meets meets all these requirements.

## 4. Various lengths of CAT6 LAN cable

: determined by the location of the equipment involved

# STEP 1: DOWNLOAD THE AURENDER APP

1. Find App Store on your iPad and open it



2. Type "Aurender Conductor" and search

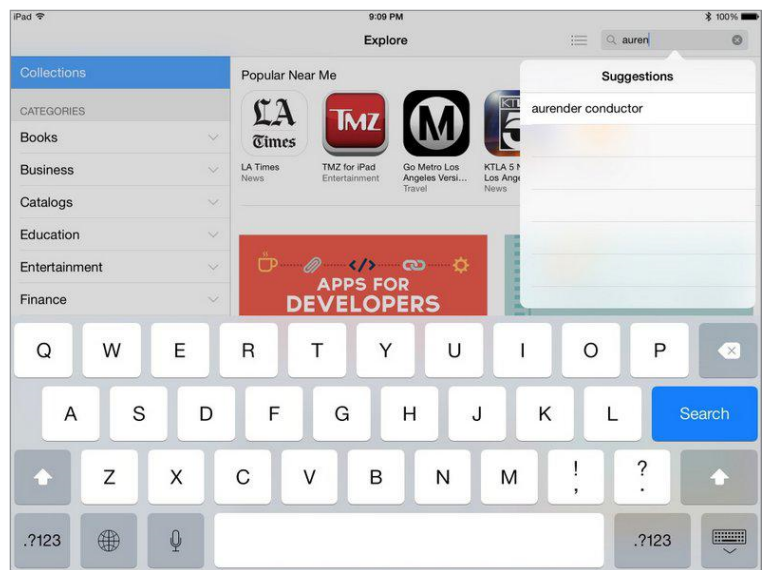

3. TADA!! GET the free Aurender Conductor App

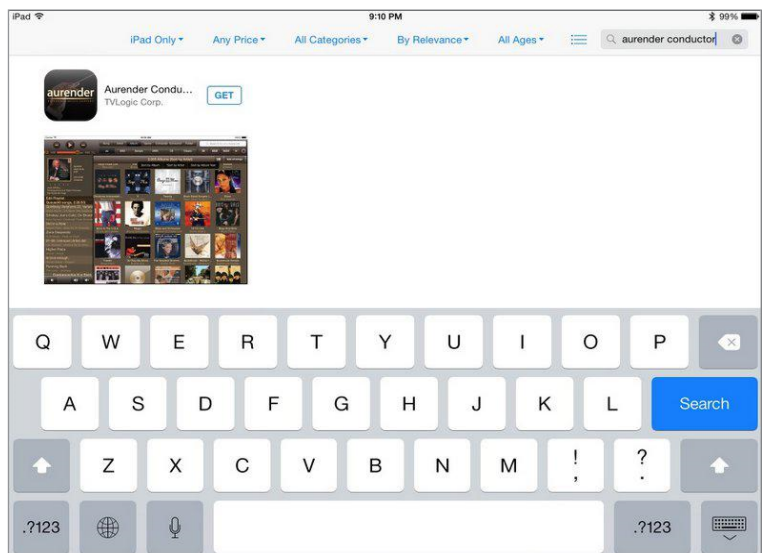

# STEP 2: CONNECT AURENDER TO YOUR LOCAL NETWORK

- When the contents are in your Mac/PC's storage or USB HDD

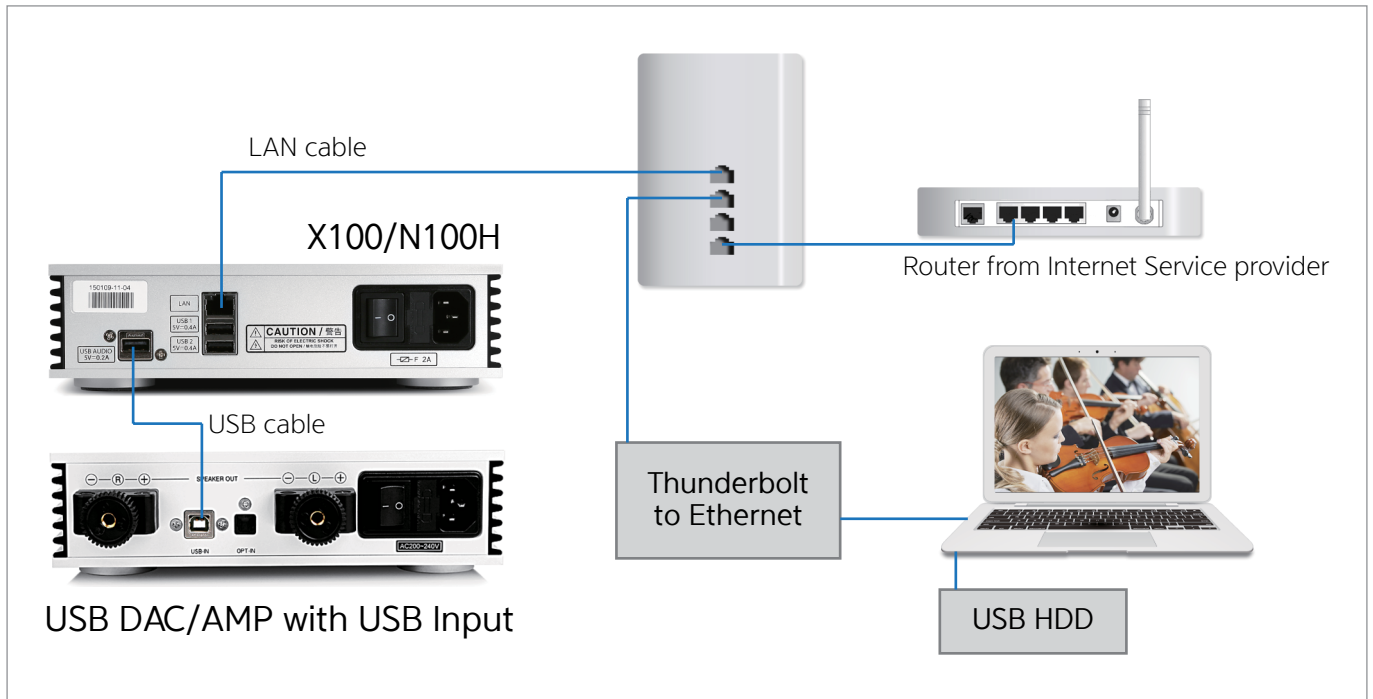

- When the contents are in the NAS

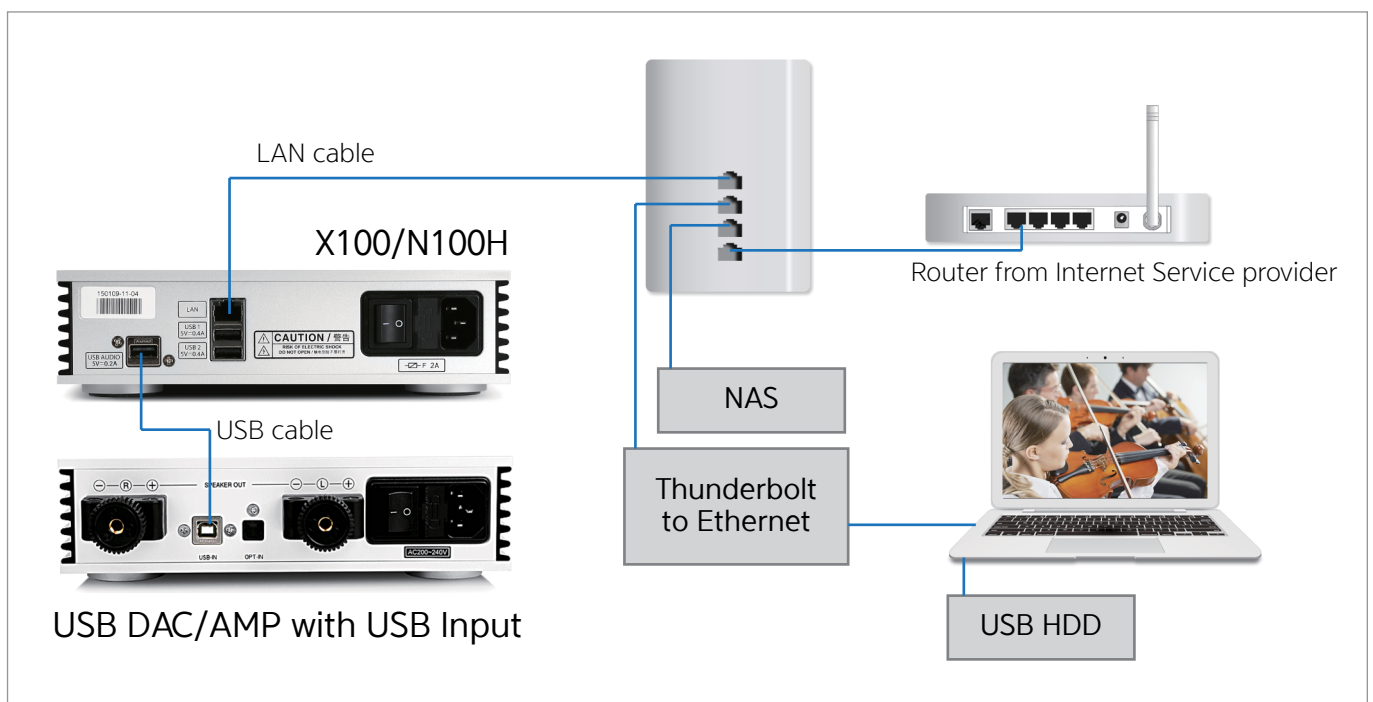

# STEP 3: UPDATE AURENDER'S SYSTEM SOFTWARE TO THE LATEST VERSION

1. Turn on the Aurender.
2. Connect the iPad to your wireless access point.  
(on your iPad: Settings -> Wi-Fi)  
\* Make sure your iPad is successfully connected to Wi-Fi

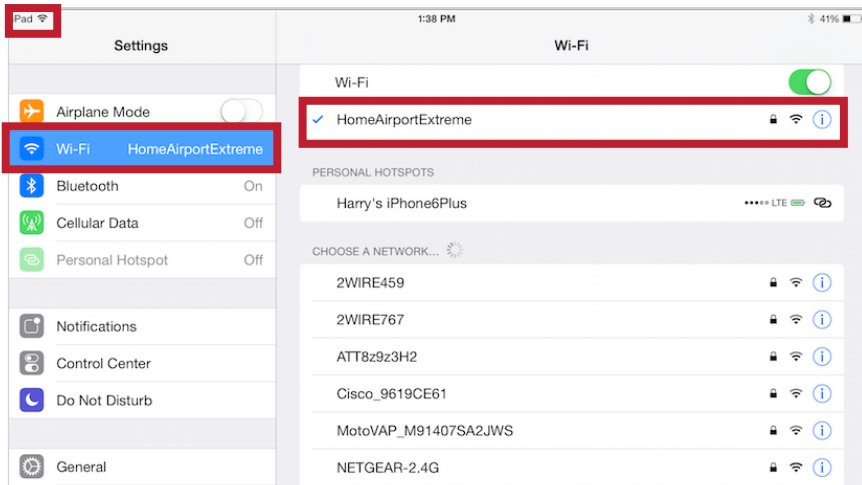

3. Open Aurender Conductor App.  
The app will connect to your Aurender **automatically** if you have only one Aurender.  
\*You'll need to select the Aurender you want to access if you have more than one unit.

4. Enter the **passcode**.  
The first time you connect the Aurender from the iPad App, you will be prompted to enter the **passcode**.  
The passcode will be shown on the front panel of the Aurender unit.

5. Tap on Settings   
After you have entered in the passcode, tap on Settings  on the upper right-hand side of the app, right below the search bar.

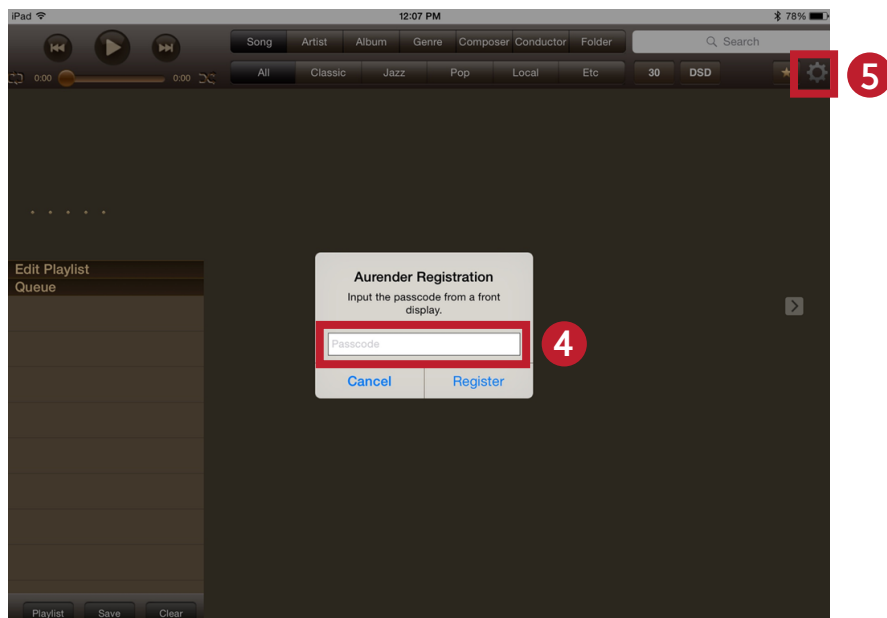

# STEP 3: UPDATE AURENDER'S SYSTEM SOFTWARE TO THE LATEST VERSION

6. Tap! "Upgrade"

7. Tap! "Upgrade to the new version"

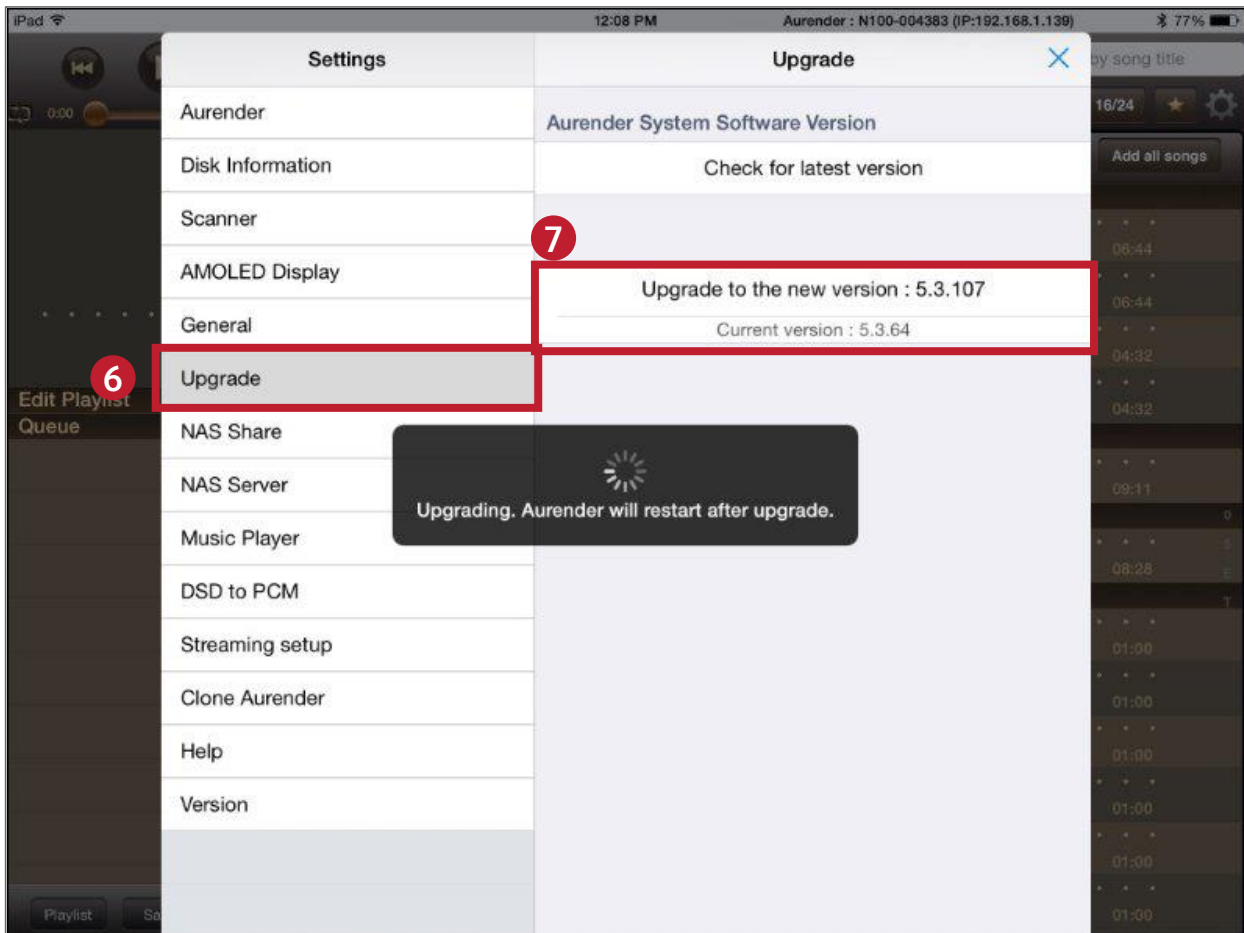

8. Upgrade will start in a few seconds and Aurender's front panel will display the status of the upgrade progress in percentages (%) completed.

9. Exit Aurender Conductor App.

10. Aurender will reboot after upgrade is done.



# STEP 4: PREPARING MUSIC CONTENT

## Loading music into the Aurender's internal drive using a Mac

### 1. Make sure your iPad is connected to Wi-Fi

(See Step 3 – #2 for detailed information)

2. On your **Aurender Conductor App**, open Settings by tapping on  and select “**NAS Share**”.

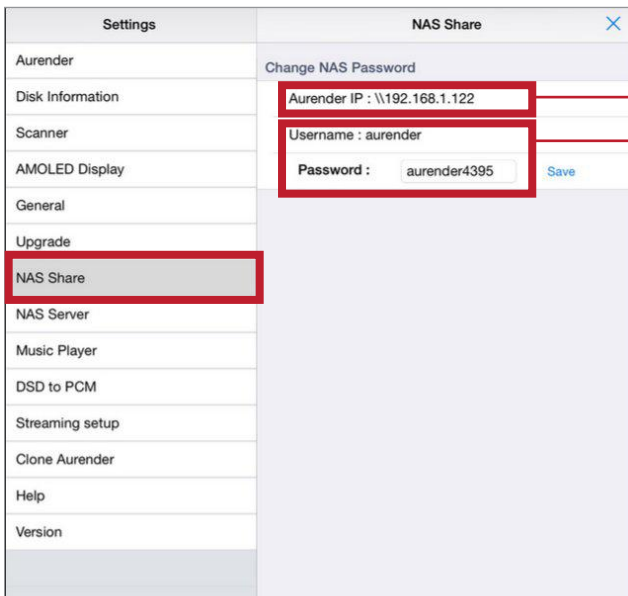

3. From your Mac, open

**Finder > Go > select Connect to Server...**

OR

press **command + k** key from the desktop.

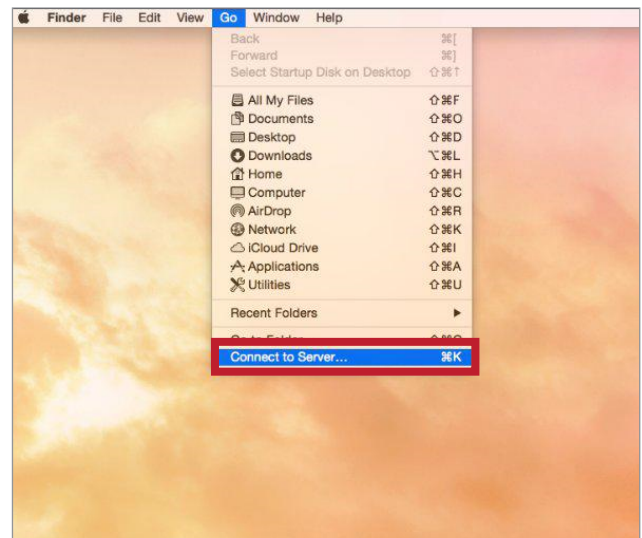

4. On your Mac, enter the appropriate **IP** address that appears on your iPad screen.

**\*\*Make sure you type in “smb://” before you type in the Aurender IP number.**



5. Enter **Name** and **Password** according to the **Username** and **Password** shown in NAS Share on the iPad.

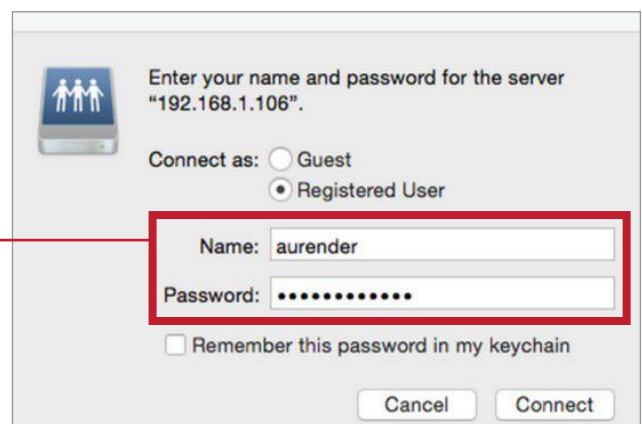



# STEP 4: PREPARING MUSIC CONTENT

## Loading music into the Aurender's internal drive using a Mac

If your Aurender (W20, N10 or X100L) has **two** internal HDDs, you will be prompted to **select** the HDD.

(It's your choice which drive to use)

\* You will not see this pop-up window with N100H.

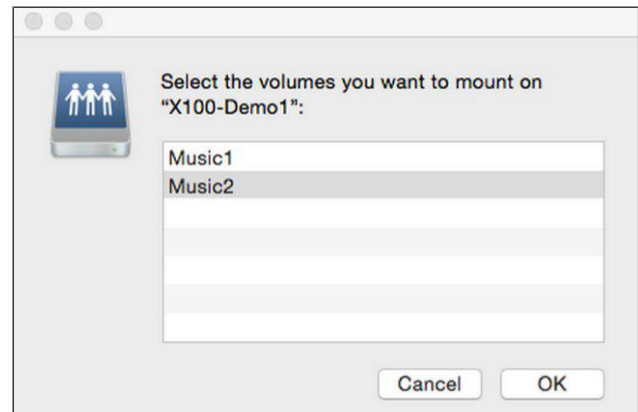

6. After you enter the Name and Password, a new finder window will appear.

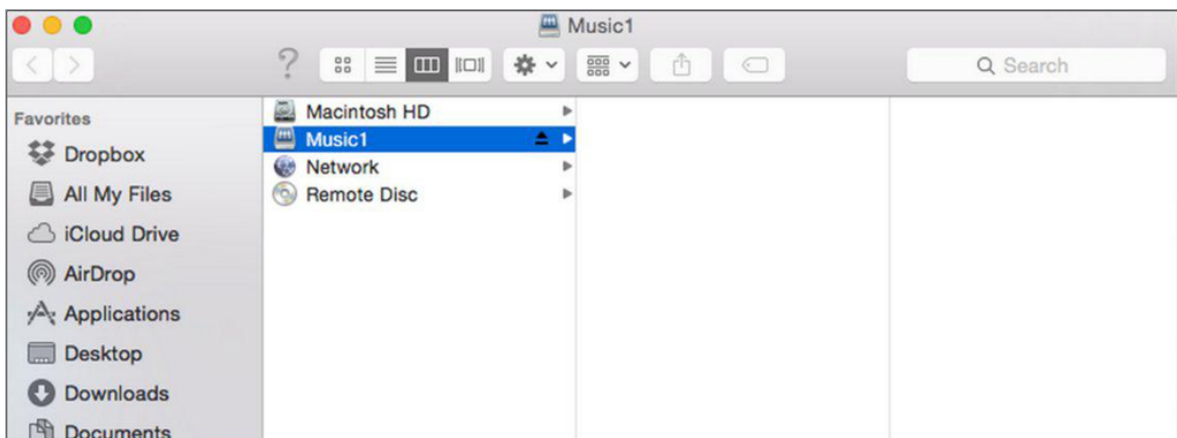

You can **drag&drop** your music folder/files you want to the folder above.

If you have multiple folders in one folder, Aurender considers the last folder in the hierarchy as one album. (Below-folder-structure will be taken care of correctly)

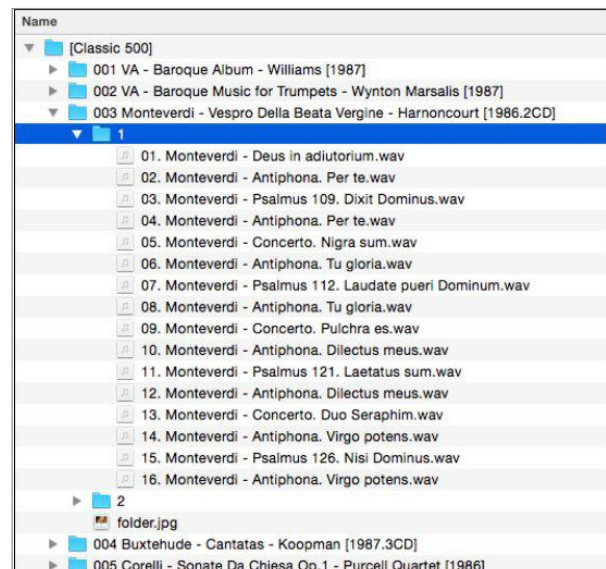

# STEP 4: PREPARING MUSIC CONTENT

## Loading music into the Aurender's internal drive using a PC

### 1. Make sure your iPad is connected to Wi-Fi

(See Step 3 – #2 for detailed information)

### 2. On your **Aurender Conductor App**, open Settings by tapping on and select “**NAS Share**”.

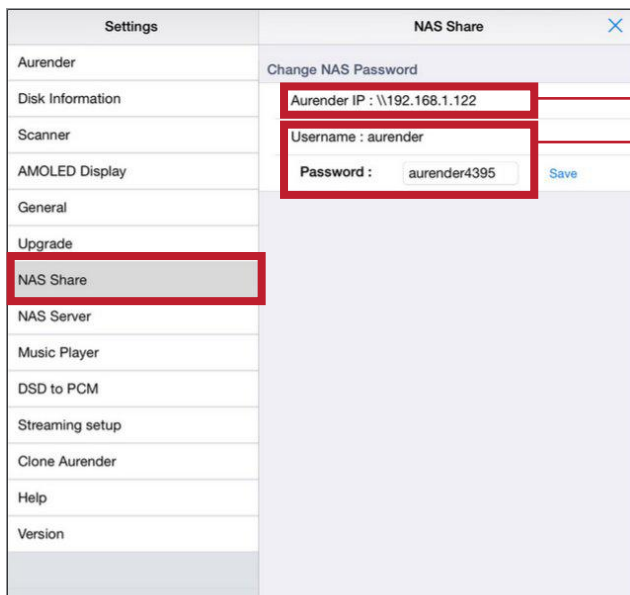

### 3. From your Windows, go to **Start > All Programs > Accessories > Run** OR

press **Windows + R** key on your keyboard.

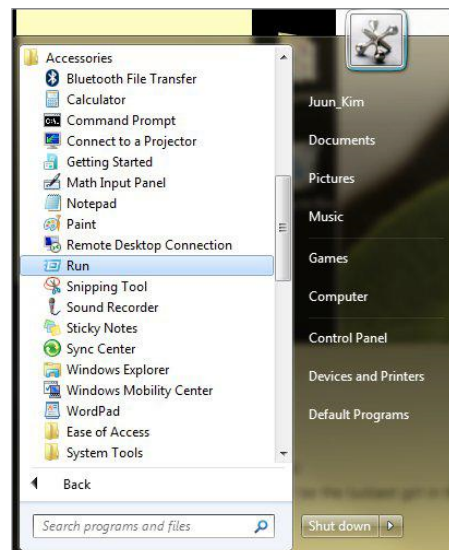

### 4. On your Windows, enter the appropriate IP number that appears on your iPad screen.

**\*\*Make sure you type in two backslashes “\\” before you type in the Aurender IP number.**

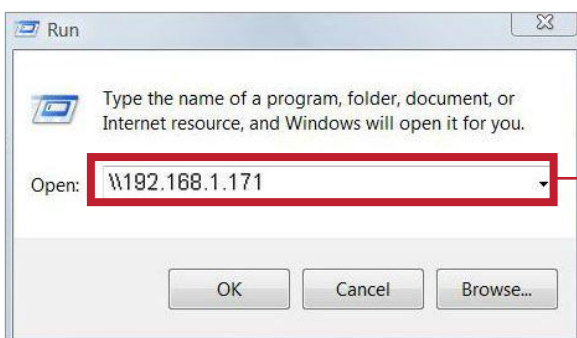

### 5. Enter **Name** and **Password** according to the **Username** and **Password** shown on the iPad.



# STEP 4: PREPARING MUSIC CONTENT

Loading music into the Aurender's internal drive using a **PC**

6. After the log-in, a **window** will appear.

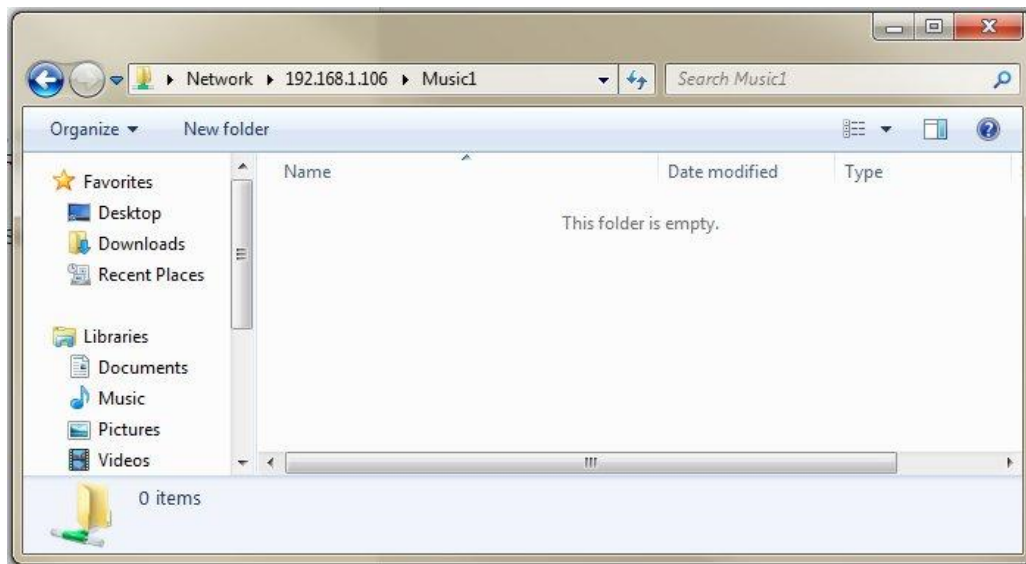

You can **drag&drop** your music folder/files you want to the folder above.

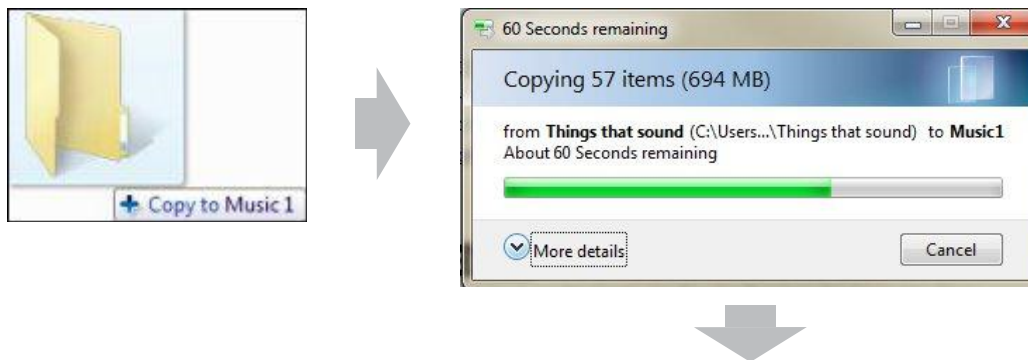

If you have multiple folders in one folder, Aurender considers the last folder in the hierarchy as one album. (Below-folder-structure will be taken care of correctly)

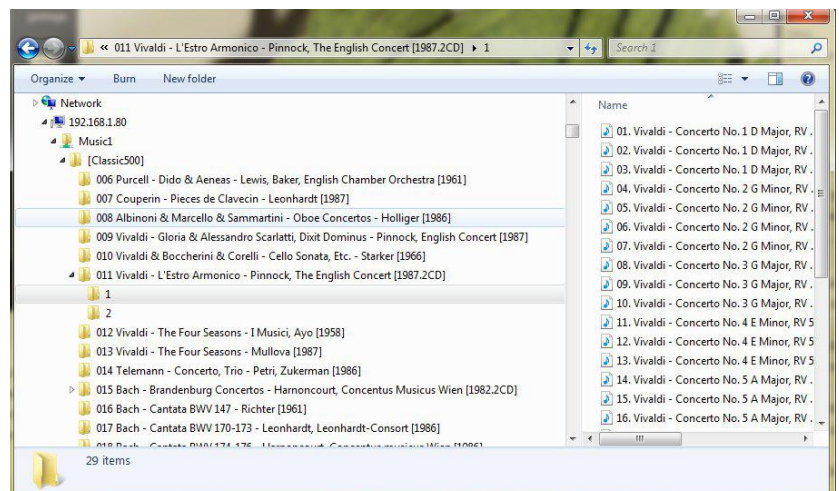

# STEP 5: PLAYING MUSIC

1. The Aurender scans music files automatically for **meta-data** and will show the album covers and artist names. It may take several minutes to hours to make the database. Until the Aurender finishes making the meta-data database, you will not see any album covers in the Aurender App as seen in the screen capture.



2. You can check the scan status in the Settings  -> Scanner menu

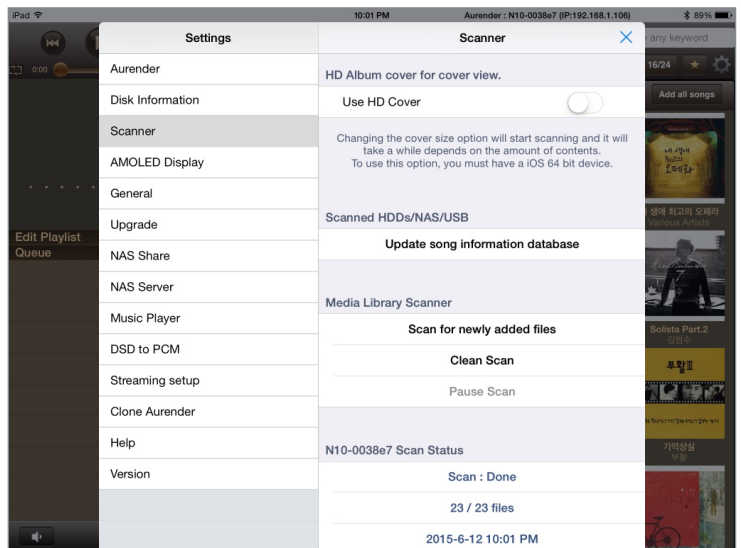

3. Once your music has been copied and scanned, you can use the Aurender conductor App to select and play your music. You can **change the view** by selecting different tabs such as **Song, Artist, Album, Genre, Composer and Conductor**.

You can also search for songs. (Make sure your view is in the right one. For example, if you are searching for an artist, you must be on the Artist tab)



# Important Notice Regarding the Power Off Procedure

Should you ever have the need to turn off the AC power of your Aurender Music Server, it is imperative to do so using the following procedure. Failure to do so may result in unmounting or corrupting the internal SSD drive crippling or rendering the unit inoperative:

To power down completely, depress the front panel power button until the power indicator light begins to flash, then release.(0.5~1Sec) When the power indicator flashing stops, the rear power switch may be switched to the off position.

Should your music server be powered down unexpectedly, for example, from a power outage, then a full factory recovery may need to be run. Please refer to the procedure in the next section.

# Procedures To Factory Restore Your Aurender

1. Make sure the unit is plugged in and the rear panel power switch is in the off position.
2. While pressing the front panel power button, switch on the back panel power switch.
3. Once the unit's display shows the Aurender logo, release the front panel power button.
4. Wait for the recovery process to finish. Once the recovery is complete, the unit will reboot.

Please note: After a factory reset recovery your system operating system may need to be updated. Additionally, if using a NAS, it will need to be remounted and you will need to run the AMM (Aurender Music Manager) to restore the erased metadata.

# aurender

---

REFERENCE MUSIC SYSTEMS

Customer Service : [support@aurender.com](mailto:support@aurender.com)

TVLogic America Co, Ltd  
209 N. Victory Blvd, Burbank, CA 91502, USA

TVLogic Co., Ltd  
Smart Audio Division,  
TVLogic Co., Ltd.  
100 Baekhyun-ro, 2802 Jeongja I-Park,  
Bungdang-gu, Seongnam, Korea.

Aurender is the registered trade mark of TVLogic.  
iPad, Airport Extreme are trademarks of Apple Inc.  
Windows is a trademark of Microsoft Inc.

All registered trademarks belong to their respective owners.



# aurender

REFERENCE MUSIC SYSTEMS

[www.aurender.com](http://www.aurender.com)