

MAGEWELL®

# Director Family

## User Manual for Director



Firmware: 3.2

Date: 12.04.2025

# TABLE OF CONTENTS

03	Introduction	
06	What's New	
17	Owners Guide	
47	Produce Your Show	
	Create and Manage Shows	47
	Create and Manage Scenes	50
	Edit Scenes	56
	Background Music	101
102	Present Your Show	
	Control Scenes	102
	Control Volume	107
	Use GFX	114
	Use Pen	147
	Control PTZ	148
	Control Phone Camera	151
	Control Webpage	153
	Control BGM	154
	Replay	155
	Use Shortcuts	159
160	Start Streaming and Recording	
	Live Streaming	160
	Record and Screenshot	179
	Album	184
187	Manage Media Files	
189	Settings	
	Network	189
	Bluetooth	192
	Display	194
	Audio	195
	Storage	196
	Encode	197
	Switch	198
	Back LED Lights	200
	HDMI/DP OUT	201
	USB Type-C	203
	Replay	205
	OSC Remote Control	207
	Shortcuts	210
	Speedify	213
	System	218
227	Battery	
231	FAQs	
249	Support	
251	Notice	
252	Glossary and Abbreviations	

# Introduction

## Director - Your All-in-One Video Companion

**Meet the Director family:** your compact solution for all things video. Whether you're directing, editing, or streaming, the Director family has got you covered. With its intuitive interface, capturing from various video sources becomes a breeze. And the best part? You can craft and share captivating content in real time, be it live streaming or recording.

### Benefits

**Diverse Video Inputs:** From HDMI and webcams to NDI<sup>®</sup> streams, [RTMP/SRT/RTSP](#) streams, webpages, phone cameras, and even video clips, you can effortlessly bring multiple perspectives into your content.

**Always Catch the Action:** With the ability to use multiple cameras, you're guaranteed not to miss a moment. The result? A richer and more engaging viewing experience.

**Enhance Your Streaming:** Show off your brand, keep score, or add any overlay you like with GFX support. Real-time control ensures your content stays fresh and professional-looking.

**Portability and Versatility:** Its compact design, dual hot-swappable battery support, and multi-network compatibility mean you can take Director to diverse events. From sports games and weddings to outdoor live broadcasts, you're set to record and stream whenever inspiration strikes.

**Director Utility App:** Gain remote control over the Director device and even use your mobile device as an additional camera. Your multi-camera setup just got more dynamic.

Embrace the freedom and flexibility of the Director family, and let your creativity shine anywhere, anytime.

## Director Family

- Director Mini: 5.44" OLED screen
- Director One: 7" OLED screen

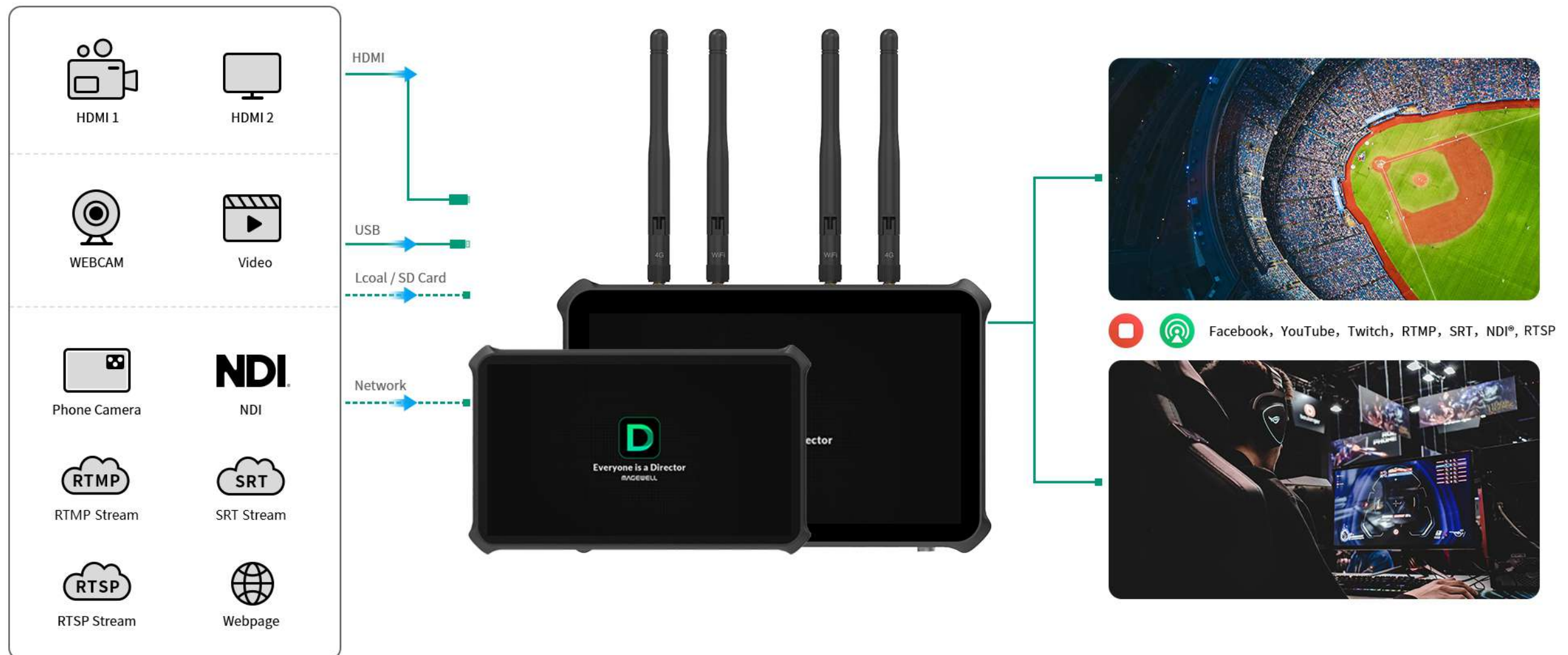

## Key Features of Director Family

- Supports multiple input sources, including 2x HDMI input, 2x USB 3.0 input, Phone Camera, [SRT](#) stream, [RTMP](#) stream, [RTSP](#) stream, NDI<sup>®</sup> stream, webpages, video clips, and pictures
- Produces shows consisting of scenes with compositions of various sources, which can be edited with diverse powerful tools, such as keyer, flip and crop
- Natively supports streaming to YouTube, Twitch and Facebook Live, supports streaming via [SRT](#), [RTMP](#) and [RTSP](#), and supports four NDI<sup>®</sup> HX3 outputs
- Supports streaming to four destinations simultaneously, up to 1080p60 30Mbps
- Supports sending live comments as overlay when streaming to social media platforms
- Supports GFX function with rich templates, supports real-time control of scoreboard, timer and stopwatch, and supports using webpages as GFXs
- Supports the ability to switch scenes directly, or preview first and then program
- Supports Replay to capture and record highlights
- Supports more interactive functions such as background music, annotation and [FTB](#)
- Supports PTZ control for HDMI, WEBCAM (UVC Camera), [SRT](#), [RTMP](#), [RTSP](#) and NDI PTZ cameras
- Supports landscape and portrait modes of device screen and external screen
- Records and takes screenshots to local storage or SD card, and exports to USB flash diver, SD card and computer
- Supports network bonding for optimal streaming stability
- Supports multiple network connection modes
- Supports connecting an external screen for monitor and connecting to a computer to import and export files, and also supports UAC/UVC output
- Supports two hot-swappable NP-F battery packs
- Supports Web UI for more settings and registering to Magewell Control Hub for centralized management. For details, please refer to the [Director Web UI User Manual](#).

# What's New

## Firmware version: 3.2

### Scene

1. When editing an HDMI source, the [Color Process](#) tool supports setting Format and Quantization.
2. Upgrade the [Color Picker](#), supporting adjusting Intensity and Brightness.
3. Supports selecting H.264 or H.265 codec when adding a [phone camera](#) source.
4. Supports changing NDI source when editing the [NDI source property](#).
5. Add a "Send to web" button to input text into a webpage, helping to switch between and fill in text fields, such as username and password.
6. Supports disabling advanced chromakey mode by default, so that when the user customizes a solid color for chromakey, similar color will not be removed.
7. Change the default camera name format of Phone Camera source, e.g., Phone Camera #1, and change the default latency to 520ms and buffer duration to 360ms.

### Shortcuts

1. Upgrade the [Shortcut](#) settings page, supporting using the Mirabox Stream Dock 293 for instant control without assigning key binds.
2. Add a [Shortcut button](#) to the  More menu, calling out the shortcut page on the main screen for instant control.
3. Add more shortcut functions, referring to the [Shortcuts for Director Device](#).
4. Supports adding multiple functions for a single shortcut key without limitation.

### Scoreboard

1. Add [tennis scoreboard](#) templates.
2. Supports [control tennis scoreboards](#).

3. Supports setting the transparency of a [scoreboard](#).

## Replay

1. Supports selecting the replay order when [replaying multiple events](#).
2. Add the [Replay Last Event](#) button, for quickly replaying the last set event.
3. Supports selecting phone camera sources and more IP stream sources as replay cameras in the [Replay](#) settings page.
4. Add Similarity, Smoothness and Spill settings to the "Chroma key for stinger transition" item in the [Replay](#) settings page.
5. Add "Switch replay camera transition" in the [Replay](#) settings page.
6. Add a 0.75s option for setting "Replay cut-in time" and "Replay cut-out time" in the [Replay](#) settings page.
7. In [Storage](#), it supports setting to save replay event files to internal storage or SD card.

## Encode, Stream and Record

1. Supports setting encode level when [editing encode schemes](#).
2. Add the Hour alignment option when setting split file by time for [record](#).
3. For [Facebook Live](#), it supports streaming to Business Pages and supports selecting Audience for streaming to Facebook Live. Audience options include Public, Friends and Only me.
4. Supports streaming to four live stream servers.

## Others

1. Supports using the USB external hard drive for file transfer.
2. Supports enabling or disabling audio for [HDMI OUT](#) and [USB-C DP OUT](#).
3. Supports controlling [fan speed](#) automatically or manually.
4. Support displaying the bandwidth of Ethernet in the Control Center.
5. Supports viewing the IMEI and setting the APN for the inserted 4G SIM card. (For Director One)

6. Supports selecting folders from the USB flash drive or SD card when exporting files.
7. Optimize the file selection page when adding picture or video sources.
8. Add a confirmation popup for power off or restart when the device is recording or streaming.
9. Supports auto-playing videos when tapping thumbnails in the Record/Replay page of the Album.

## Firmware version: 3.1

### Show and Scene

1. It supports [controlling the Phone Camera](#) with more advanced options.
2. You can select up to 100 pictures or videos as a [slide show](#), and control the playback of the slide on the scene thumbnail.
3. Each scene can contain up to 4 [private GFXs](#). You can control the private scoreboard, timer, or stopwatch via the scene's long-press menu.
4. The webpage source supports using the [CSS tool](#) to set its transparency.
5. With the [Color Process](#) tool, you can set brightness, contrast, saturation, and hue for HDMI source.
6. With a new [video control button](#) added, you can play and pause the video and adjust the progress, as well as switch to the previous and next video for a video slide show.
7. [Scene transition stingers](#) support videos of 1-5 seconds, newly including MOV and WebM files with Alpha channels, and offer Chromakey and Audio setting options.
8. It supports displaying the last frame of the [NDI source](#) when NDI signal is interrupted.
9. You can [preview transition effect](#) in the scene editor and [toggle transition in/out](#) with the transition button on the main screen.
10. It allows to add the same HDMI, webcam, phone camera or IP source multiple times within a single scene.

### GFX

1. You can use HDMI sources, Webcam sources, Video Clips and PAG (Portable Animated Graphics) files as custom GFX.
2. When using the program view as the GFX canvas background, it displays the active GFX, so that you can easily align the new GFX.

3. With an edit button added on the scoreboard control panel, you can change scores to any number quickly.
4. It supports hiding game time for soccer scoreboard.

## Stream

1. You can now stream to [SRT Listener](#) and [RTSP](#) destinations.
2. The description of YouTube server supports paragraphs, and you can edit title and description when start streaming.

## Replay

1. [Replay](#) transition stingers support videos of 1-5 seconds, newly including MOV and WebM files with Alpha channels. With replay cut-in and cut-out time settings, you can control the playback order of replay and stringer.
2. [Event Replay](#) is upgraded to support adding tags, rating, filtering events per different condition, starting loop replay with multiple events, etc.
3. You can select different replay layout and sequence when starting a dual-camera replay (only for quick replay and single event replay).

## Audio

1. When an external USB audio device is connected to the device, it pops up the detection window and you can turn on/off the audio.

## Speedify

1. **Pair & Share** feature allows easily sharing Cellular connections back and forth between multiple Speedify users on the same Wi-Fi network.
2. You can log in by entering your account and password or scanning the QR code.
3. If the login account is a team account, you can select dedicated servers.
4. You can set network priority, to determine how and when Speedify should use the connection.
5. In the Settings page, Speedify has a separated setting entry. Besides, by swiping down from the upper right corner of the main screen, you quickly access the Speedify page to login quickly and view network bonding status.

## Media File

1. With the [Media file](#) option added to the Main Menu, you can now manage media files on the device.

## System

1. Director One supports [switching the display output port between HDMI Out and DP \(USB-C\) Out](#) . When using DP (USB-C) Out, you can connect to a tablet and enable the External Screen feature of the Director Utility app.
2. When swiping down from the upper left, top center and upper right of the main screen, you can quickly visit the different page of the control center, and the control center supports swipe right and left for turning pages.
3. When the hotspot is enabled, you can view the IP address and name on the control center.
4. USB Type-C supports customizing the UVC output format, resolution and frame rate.
5. It supports closing the settings page by click X on the upper right corner to go back to the main screen quickly.
6. It supports uploading MOV and WebM files with Alpha channels as video sources and stingers.
7. The device supports more languages, including French, German, Japanese, Spanish, Portuguese, and Italian. (Beta version)

## User manual updating with Director One released in March 2025

- Add Director One (firmware version: 3.0) to Director family, especially introducing its installation, new features such as viewing SIM card information, setting HDMI Out and refresh rate, as well as checking the battery indicators.

## Director Mini Firmware History

### Firmware version: 3.0

#### Show and Scene

- **More scene sources:** You can add [RTSP](#) stream, [SRT](#) Listener, and [Webpage](#) as sources. And you can [browse the webpage](#).
- **More phone camera parameters:** You can set latency and buffer duration when adding a phone camera source.

- **Prebuilt multi-view scene layout:** Multiple prebuilt layouts help you create multi-view scenes easily and quickly.
- **Re-order scene list:** You can long-press a thumbnail and drag it to a new position, to rearrange the order of scene list.
- **More transition effects:** It provides more scene transition effects, including DIP, Wipe, DVE, Stinger and 3D.
- **Export media files:** When you export a show, you can select media files to export together.
- **Optimized Scene Editor:** Add "Undo" and "Redo" buttons for position and size changes.
- **Display a phone's battery level:** When a phone is connected to the device, you can view its battery level on the scene thumbnail.
- **Album folder:** An "Album" folder is added on the device which is easy to find when you add a video or picture source, so that you can quickly create a scene using recordings, replay event files and screenshots.

## GFX

- **NDI GFX:** You can add NDI streams as GFXs.
- **Soccer scoreboards:** Four newly added soccer scoreboards support showing stoppage time and substitution.
- **Reset game time:** You can separately reset the game time to zero or the preset duration.
- **Optimized GFX editor:** When editing a GFX, you can change the canvas background, enable timing to clear it automatically, and adjust its position and size more accurately.
- **Manage GFX list:** The GFX list can also be reordered by dragging and moving the thumbnail, and it also supports the "Rearrange/Size" button for more adjustment just like the scene list.
- GFX provides animated **Title** and **Lower Third** templates.
- You can add multiple scoreboards, timers and stopwatches, but only apply one of each kind.
- **Timer** adds the "Alert" tool to change color when it counts to the last a few minutes or seconds.

## BGM

- **Global BGM:** You can add global BGM on the Web UI, and control its playback and volume.

## Replay

- **Select camera to replay first:** For dual-camera replay, you can select the camera to replay first before it starts replay.
- **- 1f and + 1f:** You can rewind or fast forward one frame during replay.
- **Chroma key:** You can toggle on/off the chroma key for stinger transition.

## Live Stream and Record

- **Encode** and **NDI Server** support selecting different audio sources for encoding, and Multi-view is newly added as a video source.
- For YouTube streaming, it supports **streaming to YouTube for preview only and goes live later as scheduled** .
- **Album** provides "Record", "Replay" and "Screenshot" tabs to separate files.

## Network

- **Update Speedify SDK:** It optimizes the performance of network bonding and supports exporting logs.
- **USB tethering:** You can share the Internet data connection available on your mobile smartphone with Director Mini through a USB cable.
- **Captive portal support:** It supports to pop up the captive portal for authentication when joining WiFi networks.

## Others

- **Shortcuts:** You can connect a USB or Bluetooth keyboard and create Shortcuts to control the device more easily.
- **Auto full-screen:** On the main screen, if no operation for three minutes, it will automatically switch to full-screen mode, hiding all the thumbnails and buttons. And the duration of inactivity can be customized in **Display**.
- **Custom Display Color:** You can customize the display color.
- **Hotspot:** You can view and set hotspot via the control center.
- **Security for Remote Assistant:** You can set password for Remote Assistant to enhance security.

## Firmware version: 2.4.708

## Audio

- **Audio Input from Webpage GFX:** When you apply a webpage GFX in a show, the audio from the webpage can be used as an audio input.

## Firmware version: 2.4.687

### Live Stream

- **Replay:** Replay allows you capture some of greatest moments, slow down the action and save your highlights.
- **Show Live Comment:** You can select one live comment as an overlay inside the video feed when streaming to social media.
- **Optimized encoding policy:** You can stream out 1 NDI and 1 non-NDI simultaneously.

### GFX

- **Add Webpage GFX:** You can use a webpage as a GFX.
- **Select game time format:** You can select a preferred game time format when adding a common scoreboard or a baseball scoreboard.

### PTZ

- **Control OBSBOT Webcam:** You can control OBSBOT webcams, enable AI human tracking, and record videos.
- **Improve PTZ control:** It supports controlling **PTZ** and **phone camera** in non-program view, and supports switching PTZ sources.

### Show and Scene

- **Add RTMP push:** Director Mini can serve as a server to receive **RTMP** stream for the sender directly.
- **Support Full NDI input:** You can use Full NDI stream as an input source.
- **Optimized Annotation features:** The new UI of Pen enables more convenient annotation.
- **New switch mode:** It supports setting **FTB** duration separately and selecting Cut or Fade effect when quick switch is off.
- **More thumbnail sizes:** You can zoom scene thumbnails to three sizes, small, middle and large.
- **Select source by layer:** If multiple sources overlap with each other, you can select the covered layer.
- **Optimized color selector:** You can customize a color with different model, including HEX, RGB and HSL.

## Audio

- **Set global or scene-based microphone audio:** You can set MIC, Bluetooth and USB audio globally or for each scene.

## Others

- **Network Bonding:** You can use all available Internet connections to optimize live stream stability.
- **Output multi-view or preview via USB-C port:** The external screen display content supports Multi-view and Preview options, and you can even set Multi-view appearance.
- **OSC Remote Control:** Director Mini incorporates the OSC protocol, enabling you to operate the device effortlessly via the OSC protocol.
- **Check device status:** You can check the running status of the device in **Settings > System**.
- **Optimized Control Center:** It newly supports locking auto-rotate, checking device status, starting network bonding, and starting live streaming.

## Firmware version: 2.3.576

### Input information

- **View input information on the Control Center**

### Show and scene

- **Import and export shows.**
- **Customize buttons displayed on the main screen**
- **Set switch action for BGM.**
- **Control zoom and focus of phone camera on the device.**
- **Set transition effect for video clip when it is set to switch to scene xx automatically.**

### GFX

- **You can add a baseball scoreboard and control it.**

### Audio

- **Select Bluetooth audio input mode to use the Bluetooth device as an audio input source.**

- Select default mixing mode for new audio input.
- Display and control Bluetooth and USB audio input independently on audio mixer

### Recording and streaming

- Select NDI source for ISO recording
- Add 4 hours, 8 GB and 16 GB options for splitting recording file
- Select H.265 codec for encode and NDI server
- Set network priority for stream servers
- Select RTMP or HLS protocol for streaming to YouTube
- Supports RTMPS protocol for RTMP streaming

### USB-C port

- Select UVC/UAC mode for audio and video output or MTP mode for file transfer when Director Mini is connected to a computer via the USB-C port.
- Set external screen in the Settings.

### Firmware version: 2.2.650

- **Use External Touchscreen to Control the Device**

When the USB-C OUT port is connected to an external touchscreen to duplicate the screen, you can use the external touchscreen to control the device, so as to enlarge your canvas for better scene editing, annotation, etc.

- **More Frame Rate Options for Creating a Show**

You can select different frame rate when creating a show, and then the frame rates of recording, streaming, external screen and more will also change along, adapting to different scenarios.

- **ISO Recording**

Director Mini supports ISO recording. You can record two of PGM, HDMI 1, HDMI 2, WEBCAM 1 and WEBCAM 2, or record two-channel images with different quality for one source.

- **WEBCAM as Encoding Source**

When setting [Encode](#) or [editing NDI streaming server](#), you can select WEBCAM 1 or WEBCAM 2 as the encoding source.

- **Optimized Audio Mixer**

Audio input sources can be linked globally or disconnected with separated settings for each scene

- **NDI Tally**

During NDI streaming, the top status bar supports displaying the PGM and PVW status of the NDI signal. You can also set the [Back LED Lights](#) as NDI tally lights.

- **Adjusting Input Delay of USB Microphone**

You can adjust the input delay of USB microphone through  > Settings > Audio.

- **APIs for Third-party Control System**

Director Mini provides rich APIs for developers to interact with the device such as switch scenes, apply GFX, play video and BGM, control audio and start/stop streaming and recording. These APIs are based on the Hyper Text Transfer Protocol (HTTP) and are lightweight and connectionless interfaces without response data. Visit [Director Mini API](#) for detailed understanding of each API's function and request mode.

# Owners Guide

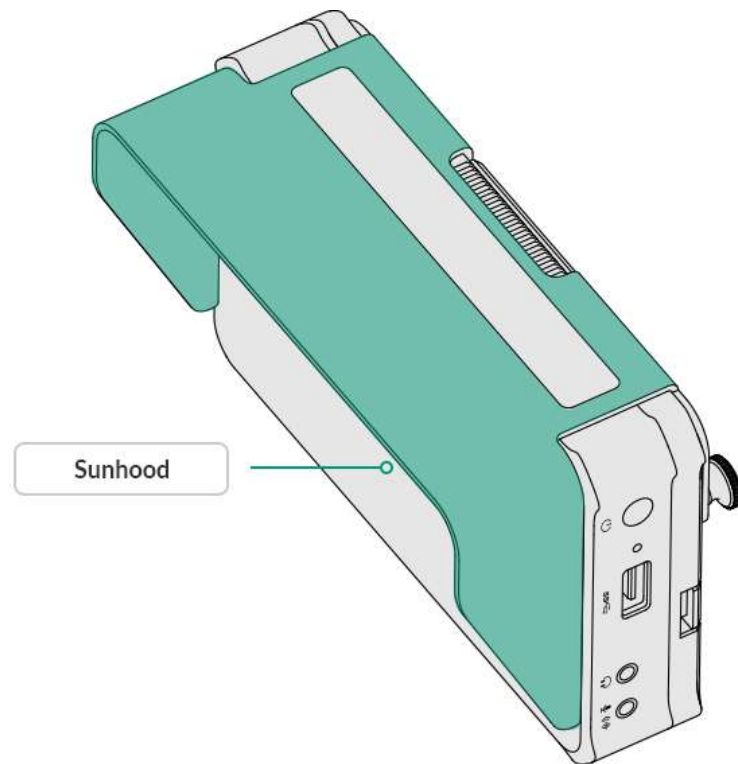
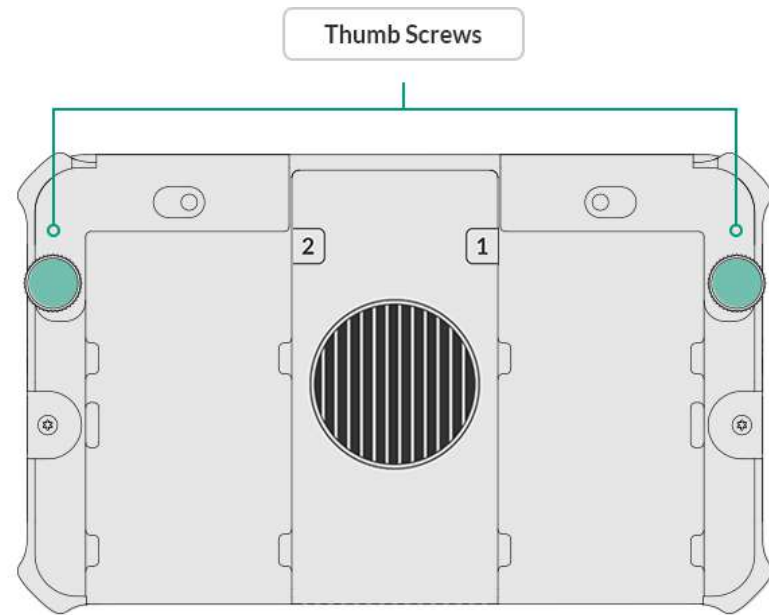

## Getting Started with Director Mini

Make sure Director Mini is mounted safely before using it.

- Place the device on a flat and stable surface. Director Mini provides two detachable foldable stands for better heat dissipation and convenient operation. You can use the stands as needed.
  - **Install:** press the lock button first and put the stand into the slots until it is locked in the correct position.
  - **Remove:** press the lock button first and remove the stand.
- Mount the device with a tripod or camera through the 1/4" mount hole. The screw should be less than 5.5 mm (7/32 inches) long. Otherwise, you cannot firmly secure the device, and damage may occur.
- When using outdoors, you can use the sunhood to prevent glare on the screen by blocking out ambient light.
  1. Slide down the sunhood till the mounting holes line up with the mounting holds on the back of the device.
  2. Tighten the two thumb screws.

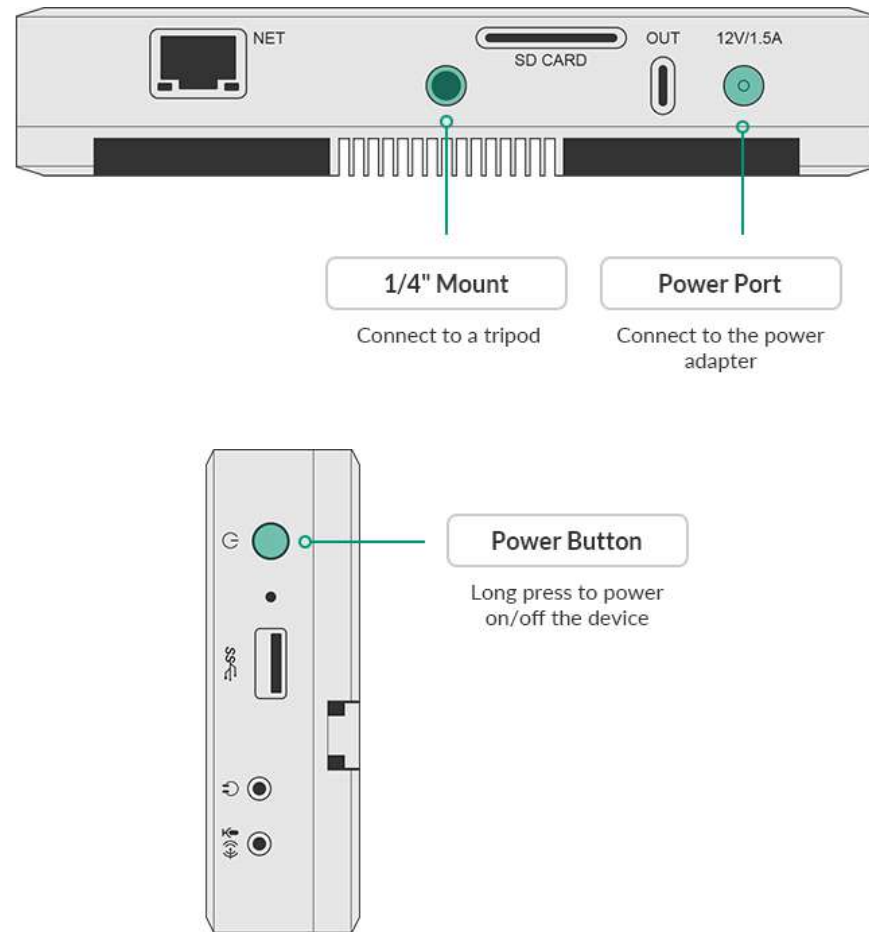

## Connect to Power and Turn on the Device

Use the supplied power adapter to connect the power port.

💡 Director Mini also supports optional two hot-swappable NP-F battery packs. For more information, refer to [Battery](#).

## Power Button Actions

### Power on

Long-press the power button for 3 seconds to power on.

### Power off

Long-press the power button till a menu bar pops up, and tap **Power off**.

### Restart

Long-press the power button till a menu bar pops up, and tap **Restart**.

### Screenshot

Long-press the power button till a menu bar pops up, and tap **Screenshot**, so that you take a screenshot which saves all the information on the screen.

### Turn off the screen

Short-press the power button to turn off the screen, and press it again to turn on the screen.

## Complete Initial Settings

The first time you power on your Director Mini device or after you reset the device, you will be prompted to select your language, set your device name and read End User License Agreement (EULA). Please follow the guide step by step to complete the initial settings.

Next, you can select to load a show in landscape or portrait mode.

Then, you can follow the on-screen guide to know the functions of buttons on the screen. After that, you enter the default show, which consists of 5 scenes, a default picture, HDMI 1, HDMI 2, webcam, and phone camera.

Then, you can connect HDMI and webcam sources.

Meanwhile, you can use your phone to download the Director Utility App, and

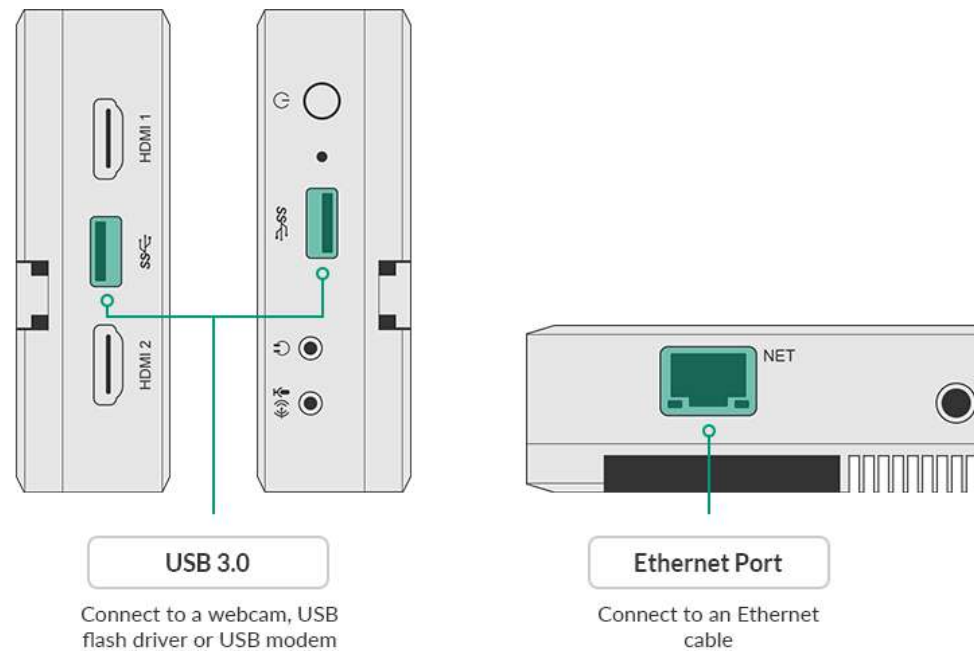

then try to connect Phone Camera. For details, please refer to [Director Utility App User Manual](#).

## Connect to Network

Director Mini supports wired and Wi-Fi networks. These networks can be connected at the same time. The priority order for the device selecting network connection is Ethernet > Wi-Fi > Cellular.

- **Connect to Ethernet**  
Use an Ethernet cable to connect the Ethernet port.
- **Connect to Wi-Fi**  
Tap  > **Settings** > **Network** to connect Wi-Fi. For details, please refer to [Network](#).
- **Connect to Cellular**
  - Insert a USB modem to the USB port. Refer to [USB Modem supported by Magewell Products](#) for more details.
  - Connect your mobile phone with Director Mini through a USB cable, and enable **Personal Hotspot** on your phone. (Tips: This function may not be available on all mobile phones due to hardware or system limitations.)

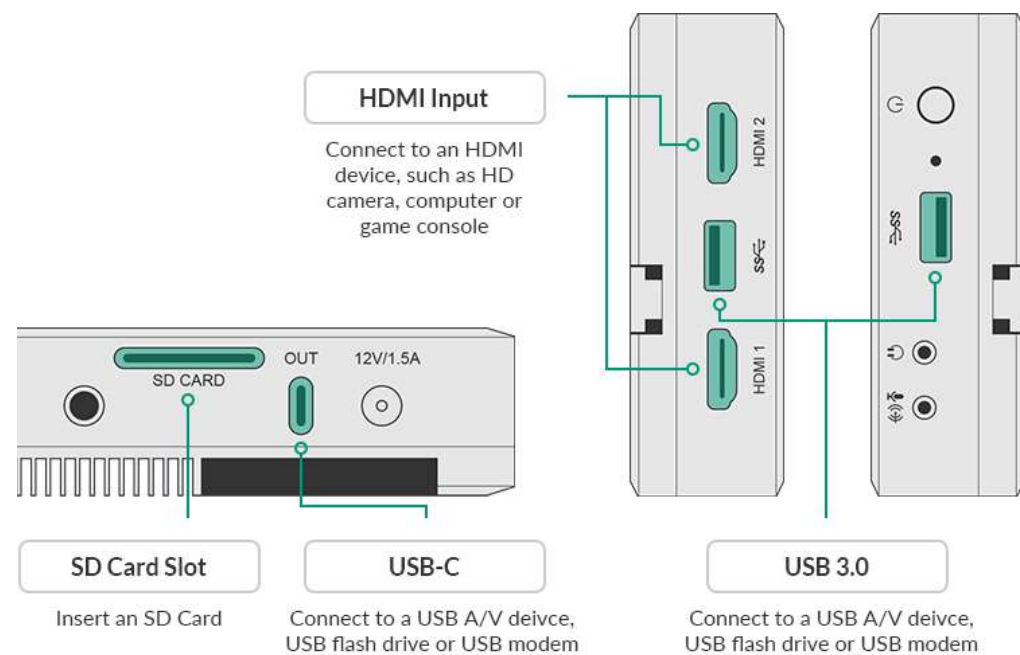

## Connect to Input Devices

Director Mini supports various sources, including HDMI sources, webcam, stream, Phone Camera, webpage, video clips and pictures. You can connect one or more sources to Director Mini according to the following introductions.

💡 For how to connect to stream, webpage and Phone Camera source, please refer to [Add Source](#).

### ▪ Connect to HDMI source

Connect one or two HDMI devices, such as HD camera, computer and game console, to the HDMI ports of Director Mini. It supports to capture signals from the two HDMI ports at the same time. The thumbnail of the corresponding input signal appears in the scene list of default show.

Supported typical HDMI inputs include:

- 4096x2160p/3840x2160p 23.98/24/25/29.97/30/59.94/60
- 1920x1080p 23.98/24/25/29.97/30/50/59.94/60
- 1920x1080i 25/29.97/30
- 1280x720p 23.98/24/25/29.97/30/50/59.94/60
- 720x576p 50/100
- 720x576i 25/50
- 720x480p 59.94/60
- 720x480i 29.97/30

When you connect a PC as the HDMI source, you need to select Director Mini as the audio output device on the PC. For example, on Windows 10, click > > System > Sound. In the Output section, choose **Director Mini (\*\*\*\*\*)** from the drop-down list box of **Choose your output device**, such as **Director**

### Mini (Intel(R) Display Audio).

- **Connect to WEBCAM**

Connect webcams to the USB ports of Director Mini.

Supported webcam specifications include:

- Formats: YUYV, MJPG, NV12, UYUV
- Resolution: up to 1920x1080
- Frame rate: up to 60 fps

Refer to [webcam frame rate information](#) for decide how to connect your webcams.

- **Connect to media source**

Insert a SD card or USB flash drive to import picture, video and audio files.

The supported file system types include: FAT32 (The maximum file size is 4GB.), exFAT, and NTFS.

Director Mini also supports transferring files through the computer. For more details, refer to [How to import/export files](#).

For more information about the devices supported by USB 3.0 ports, please refer to [How to use the USB 3.0 ports](#).

The USB-C port is a multifunctional port. You can refer to [what can the USB-C OUT port be used for?](#)

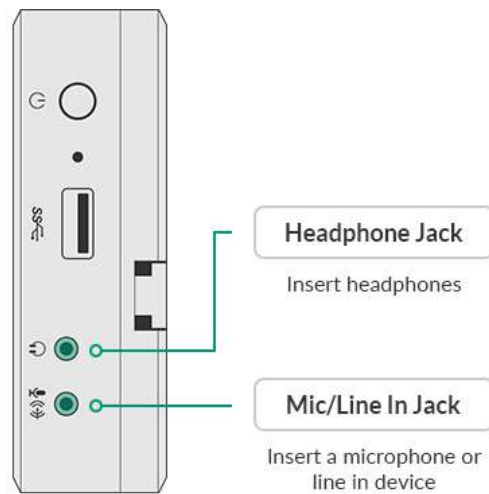

## Connect to Audio Devices

- **Connect microphone or line in device**

Connect an active microphone or line in device to the Mic/Line In jack on Director Mini, and select the device type according to the prompt.

For MIC device, the system will automatically provide 20dB gain.

It also supports HDMI microphone or USB microphone. When an external USB audio device is connected to the device, the detection window pops up and you can turn on/off the audio.

- **Connect headphones**

Connect your headphones to the Headphone jack on Director Mini to monitor the audio.

It also supports USB audio playback device.

You can also use a Bluetooth device for audio output or input, and please refer to [Bluetooth](#).

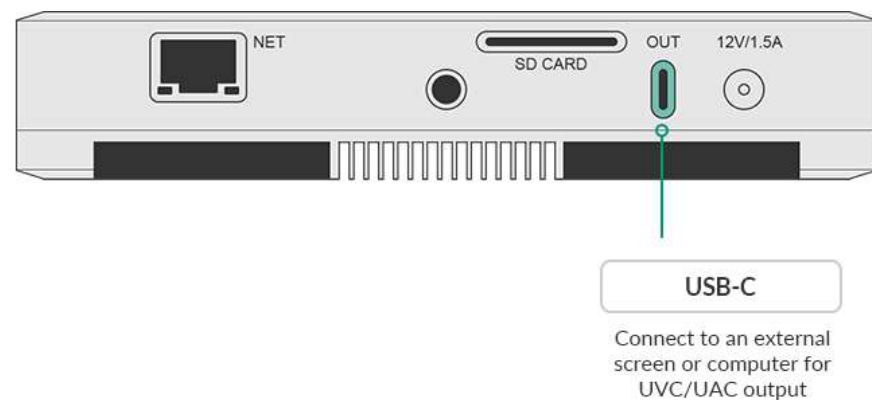

### (Optional) Connect to External Screen

Director Mini can be connected to an external screen through the USB-C OUT port, supporting 1920x1080@60Hz or 1920x1080@50Hz according to the show's frame rate. For the details, please refer to [Mapping between the show's frame rate and each output frame rate](#).

Besides, when Director Mini is connected to an external touchscreen and set to "Duplicate Screen", you can use the external touchscreen to control the device, so as to enlarge your canvas for better scene editing, annotation, etc.

1. Use a Type-C to HDMI / VGA / DP adapter to connect a monitor, HDTV or other devices to the USB-C OUT port of Director Mini. The external screen setting page will pop up on the device.
  2. Select the content to be displayed on the external screen.
    - Clean Program: output a clean program signal.
    - Preview: output preview signal
    - Multi-view: display 8 video boxes showing scene thumbnails at the bottom, and two larger boxes at the top, with the left one showing Preview view and the right one showing Program view. You can change the Multi-view appearance, referring to [USB Type-C](#).
    - Duplicate Screen: duplicate all the elements on the device screen of Director Mini.
    - Loop HDMI 1: loop out the signal from HDMI 1.
    - Loop HDMI 2: loop out the signal from HDMI 2.
3. Select the rotation angle to fit for the external screen: rotate 90° to left, or rotate 90° to right.
4. Tap the device screen to go back.

5. To change the settings of the external screen, swipe down from the top of the device screen, and then tap  on the Control Center to open the external screen setting window.

 Notice for using the external touchscreen to control Director Mini:

- The external touchscreen must support HID multi-touch function (no need of driver).
- Connect the touchscreen and Director Mini with a Type-C to Type-C cable. If you use a Type-C adapter, please connect the Touch Function port of the touchscreen to the device. For details, please refer to your touchscreen's user manual.
- Select Duplicate Screen as the displayed content.
- The external touchscreen should keep the full screen mode and the same orientation as the Director Mini device.

The USB-C port also supports to connect a computer for UVC/UAC output, connect a USB-C hub for more A/V input, etc. For details, refer to [What can the USB-C OUT port be used for?](#)

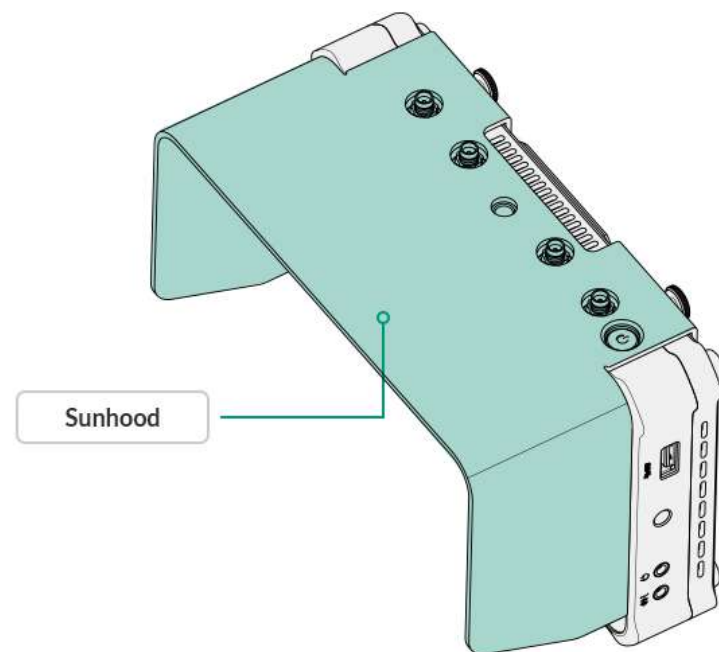
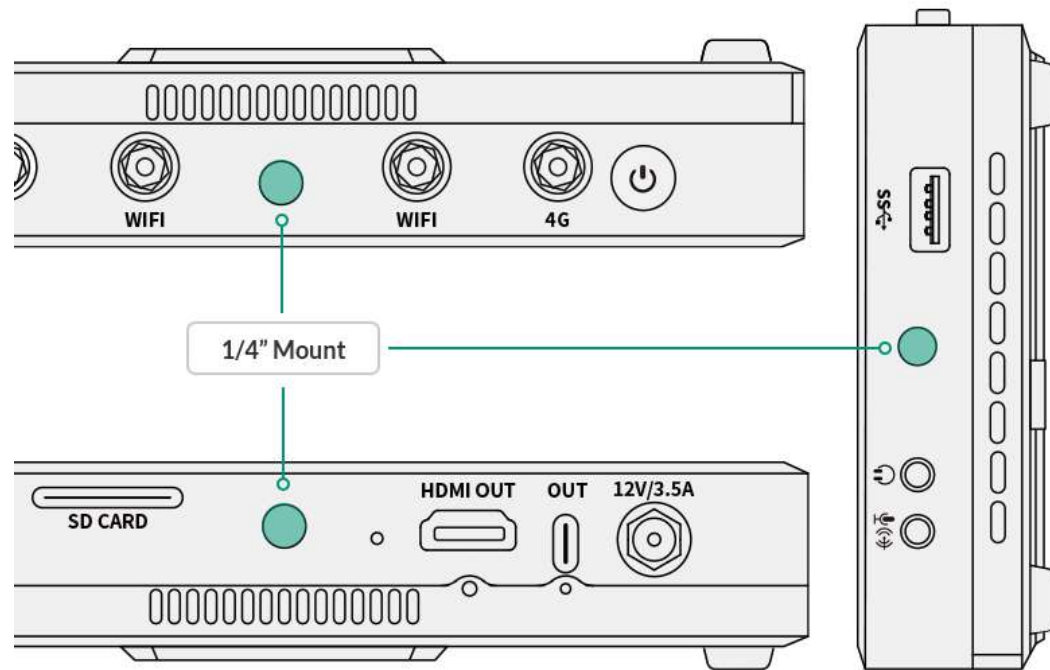

## Getting Started with Director One

Make sure Director One is mounted safely before using it.

- Place the device on a flat and stable surface.
- Or, mount the device with a tripod or camera through a 1/4" mount hole. The screw should be less than 5.5 mm (7/32 inches) long. Otherwise, you cannot firmly secure the device, and damage may occur.
- When using outdoors, you can use the sunhood to prevent glare on the screen by blocking out ambient light.
  1. Slide down the sunhood till the mounting holes line up with the mounting holds on the back of the device.
  2. Tighten the two thumb screws.

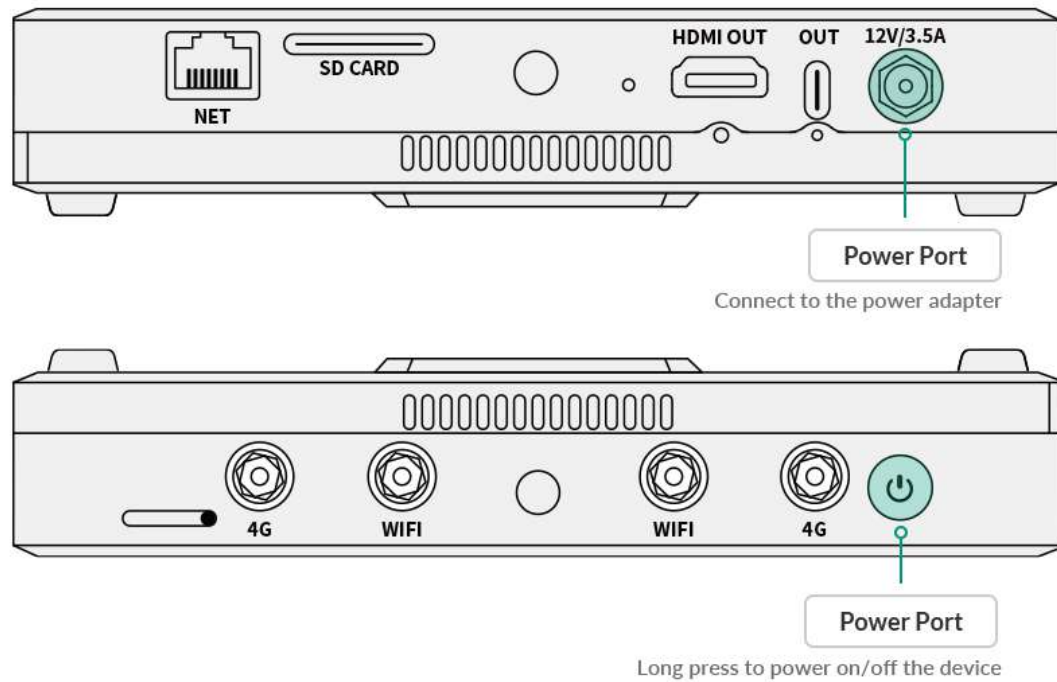

## Connect to Power and Turn on the Device

Use the supplied power adapter to connect the power port.

💡 Director One also supports optional two hot-swappable NP-F battery packs. For more information, refer to [Battery](#).

## Power Button Actions

### Power on

Long-press the power button for 3 seconds to power on.

### Power off

Long-press the power button till a menu bar pops up, and tap **Power off**.

### Restart

Long-press the power button till a menu bar pops up, and tap **Restart**.

### Screenshot

Long-press the power button till a menu bar pops up, and tap **Screenshot**, so that you take a screenshot which saves all the information on the screen.

### Turn off the screen

Short-press the power button to turn off the screen, and press it again to turn on the screen.

## Complete Initial Settings

The first time you power on your Director One device or after you reset the device, you will be prompted to select your language, set your device name and read End User License Agreement (EULA). Please follow the guide step by step to complete the initial settings.

Next, you can select to load a show in landscape or portrait mode.

Then, you can follow the on-screen guide to know the functions of buttons on the screen. After that, you enter the default show, which consists of 5 scenes, a default picture, HDMI 1, HDMI 2, webcam, and phone camera.

Then, you can connect HDMI and webcam sources.

Meanwhile, you can use your phone to download the Director Utility App, and then try to connect Phone Camera. For details, please refer to [Director Utility App User Manual](#).

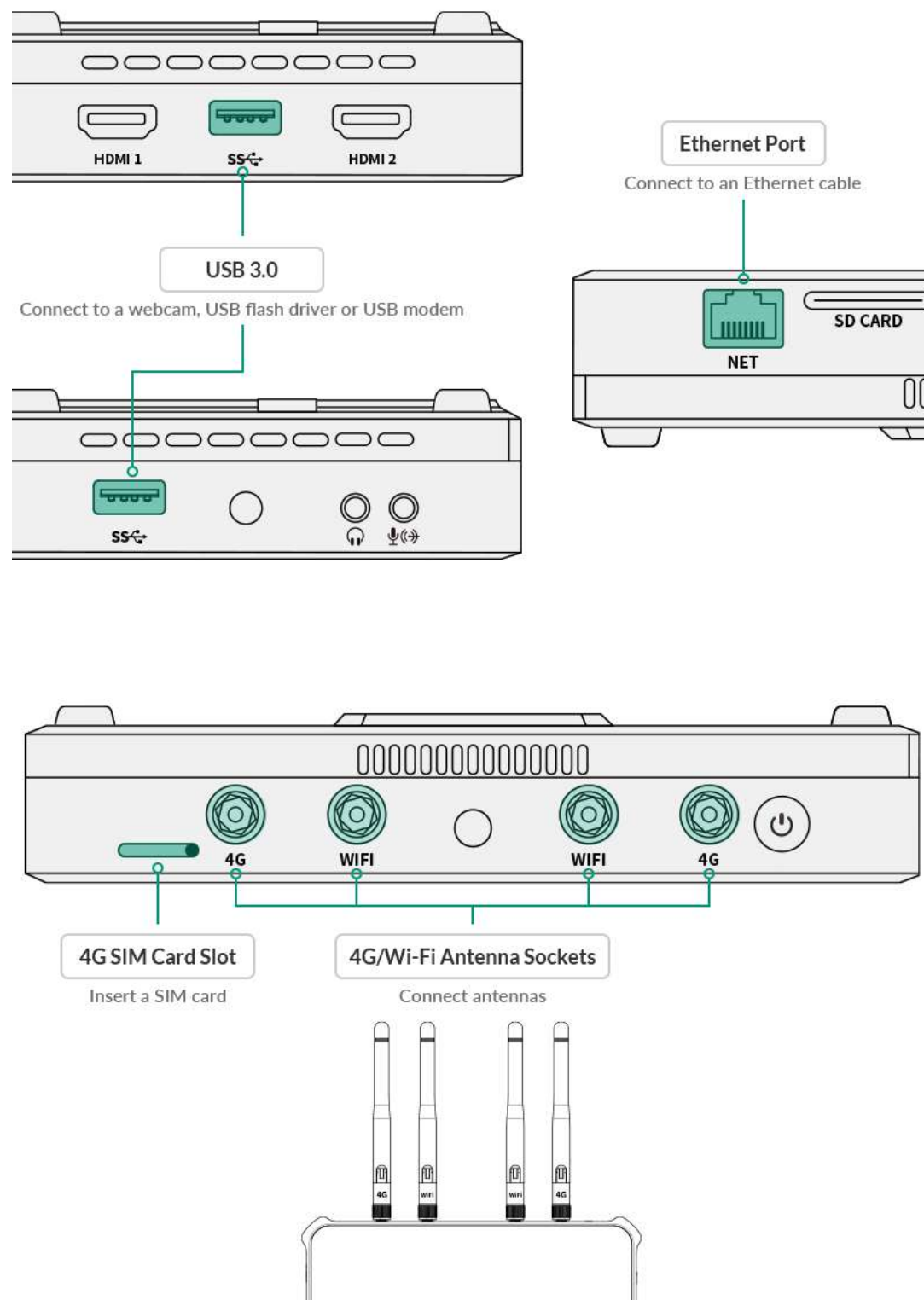

## Connect to Network

Director One supports multiple networks. These networks can be connected at the same time. The priority order for the device selecting network connection is Ethernet > Wi-Fi > Cellular.

### 1. Connect antennas

Connect the supplied 4G and Wi-Fi antennas to the unit.

Note that the antennas for WiFi and 4G are not interchangeable. The two WiFi antennas have a reversed connection (RP-SMA) to match industry standards.

### 2. Connect Network

Director One must be connected to a network first in order to stream to destinations.

#### ▪ Connect to Ethernet

Use an Ethernet cable to connect the Ethernet port.

#### ▪ Connect to Wi-Fi

Tap  > **Settings** > **Network** to connect Wi-Fi. For details, please refer to [Network](#).

#### ▪ Connect to Cellular

▪ Insert a SIM card to the 4G SIM card slot.

▪ Insert a USB modem to the USB port. Refer to [USB Modem supported by Magewell Products](#) for more details.

▪ Connect your mobile phone with Director One through a USB cable, and enable **Personal Hotspot** on your phone. (Tips: This function may not be available on all mobile phones due to hardware or system limitations.)

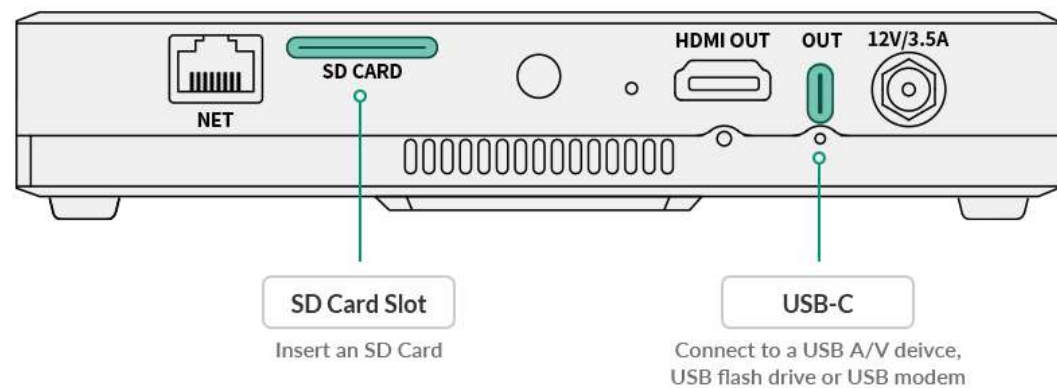
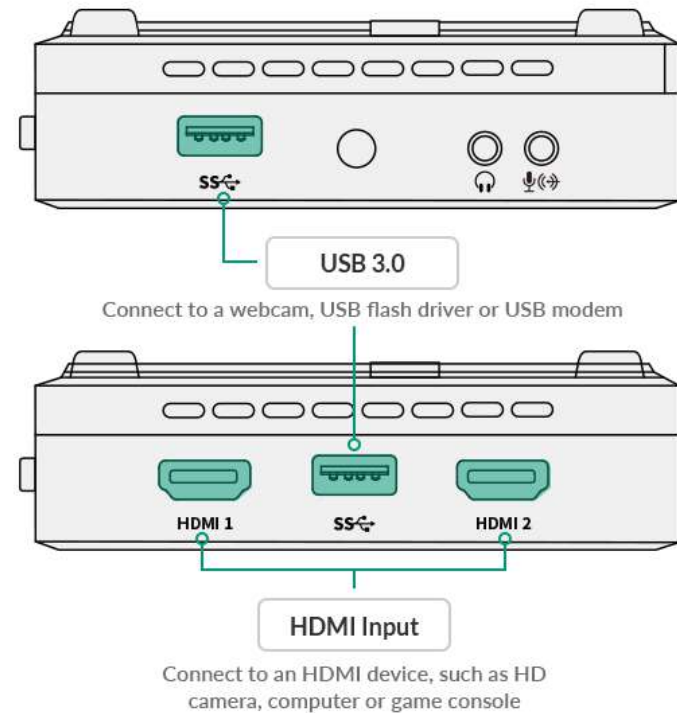

## Connect to Input Devices

Director One supports various sources, including HDMI sources, webcam, streams, Phone Camera, webpage, video clips and pictures. You can connect one or more sources to Director One according to the following introductions.



💡 For how to connect to stream, webpage and Phone Camera source, please refer to [Add Source](#).

### ▪ Connect to HDMI source

Connect one or two HDMI devices, such as HD camera, computer and game console, to the HDMI ports of Director One. It supports to capture signals from the two HDMI ports at the same time. The thumbnail of the corresponding input signal appears in the scene list of default show.

Supported typical HDMI inputs include:

- 4096x2160p/3840x2160p 23.98/24/25/29.97/30/59.94/60
- 1920x1080p 23.98/24/25/29.97/30/50/59.94/60
- 1920x1080i 25/29.97/30
- 1280x720p 23.98/24/25/29.97/30/50/59.94/60
- 720x576p 50/100
- 720x576i 25/50
- 720x480p 59.94/60
- 720x480i 29.97/30

When you connect a PC as the HDMI source, you need to select Director One as the audio output device on the PC. For example, on Windows 10, click  >  > System > Sound. In the Output section, choose **Director One (\*\*\*\*\*)** from the drop-down list box of **Choose your output device**, such as **Director**

### One (Intel(R) Display Audio).

- **Connect to WEBCAM**

Connect webcams to the USB ports of Director One.

Supported webcam specifications include:

- Formats: YUYV, MJPG, NV12, UYUV
- Resolution: up to 1920x1080
- Frame rate: up to 60 fps

Refer to [webcam frame rate information](#) for decide how to connect your webcams.

- **Connect to media source**

Insert a SD card or USB flash drive to import picture, video and audio files.

The supported file system types include: FAT32 (The maximum file size is 4GB.), exFAT, and NTFS.

Director One also supports transferring files through the computer. For more details, refer to [How to import/export files](#).

For more information about the devices supported by USB 3.0 ports, please refer to [How to use the USB 3.0 ports](#).

The USB-C port is a multifunctional port. You can refer to [what can the USB-C OUT port be used for?](#)

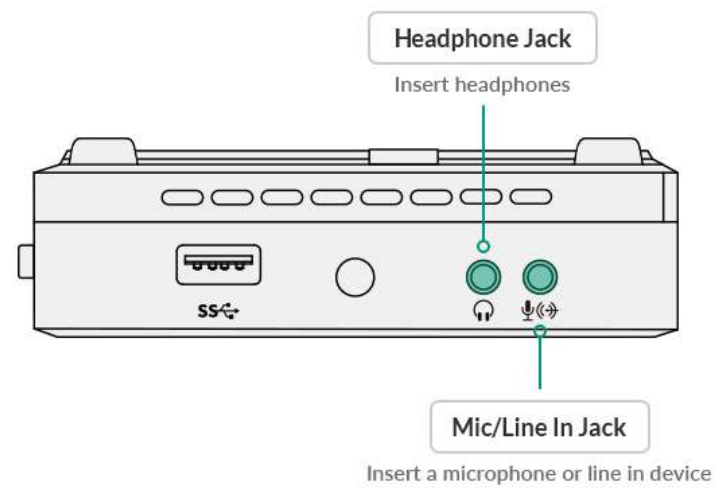

## Connect to Audio Devices

- **Connect microphone or line in device**

Connect an active microphone or line in device to the Mic/Line In jack on Director One, and select the device type according to the prompt.

For MIC device, the system will automatically provide 20dB gain.

It also supports HDMI microphone or USB microphone. When an external USB audio device is connected to the device, the detection window pops up and you can turn on/off the audio.

- **Connect headphones**

Connect your headphones to the Headphone jack on Director One to monitor the audio.

It also supports USB audio playback device.

You can also use a Bluetooth device for audio output or input, and please refer to [Bluetooth](#).

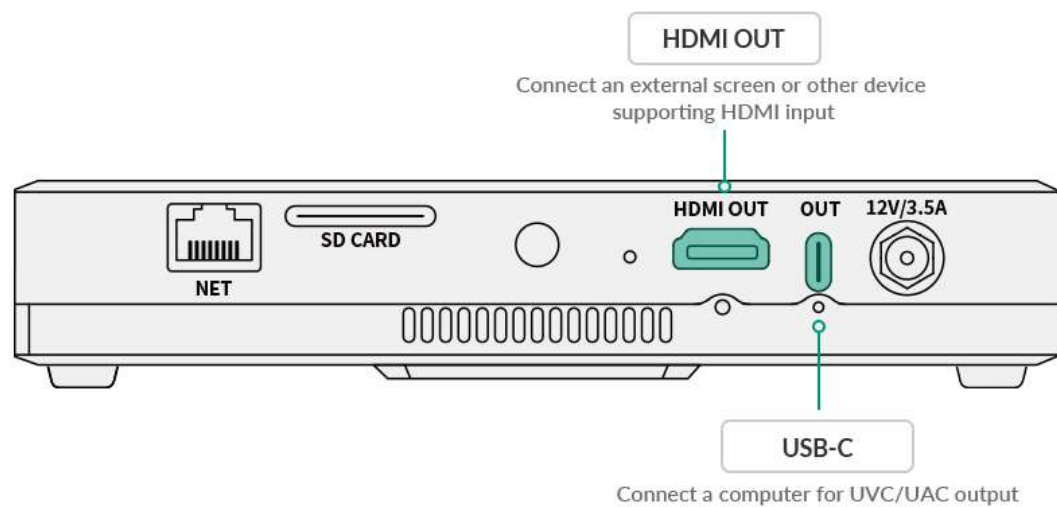

### (Optional) Connect to External Screen

Director One can be connected to an external screen through the HDMI OUT port, supporting 1920x1080@60Hz or 1920x1080@50Hz according to the show's frame rate. For the details, please refer to [Mapping between the show's frame rate and each output frame rate](#).

1. Use an HDMI cable to connect a monitor, HDTV or other devices to the HDMI OUT port of Director One. The external screen setting page will pop up on the device.
2. Select the content to be displayed on the external screen.
  - Program: output program signal
  - Preview: output preview signal
  - Multi-view: display 8 video boxes showing scene thumbnails at the bottom, and two larger boxes at the top, with the left one showing Preview view and the right one showing Program view. You can change the Multi-view appearance, referring to [HDMI/DP OUT](#).
  - Duplicate Screen: duplicate all the elements on the device screen of Director One.
  - Loop HDMI 1: loop out the signal from HDMI 1.
  - Loop HDMI 2: loop out the signal from HDMI 2.
3. Select the rotation angle to fit for the external screen: rotate 90° to left, or rotate 90° to right.
4. Tap the device screen to go back.
5. To change the settings of the external screen, swipe down from the top of the device screen, and then tap  on the Control Center to open the external screen setting window.

Besides, when Director One is connected to an external touchscreen and set to "Duplicate Screen", you can use the external touchscreen to control the device, so as to enlarge your canvas for better scene editing, annotation, etc.

 Notice for using the external touchscreen to control Director One:

- The external touchscreen must support HID multi-touch function (no need of driver).
- Connect the HDMI OUT port of Director One to the touchscreen, and connect the Touch Function port of the touchscreen to any USB port of Director One. For details, please refer to your touchscreen's user manual.
- Select Duplicate Screen as the displayed content.
- The external touchscreen should keep the full screen mode and the same orientation as the Director One device.

Director One can also use the USB-C Out port for DP output, to connect an external screen or other devices supporting DP signal. You can go to  > **Settings > HDMI/DP Out** and then select **DP (USB-C) Out** as the **Display output port**.

## Main Screen

Director device provides lots of easy-to-use buttons on the main screen, and supports landscape mode and portrait mode. You can produce and stream your show very easily.

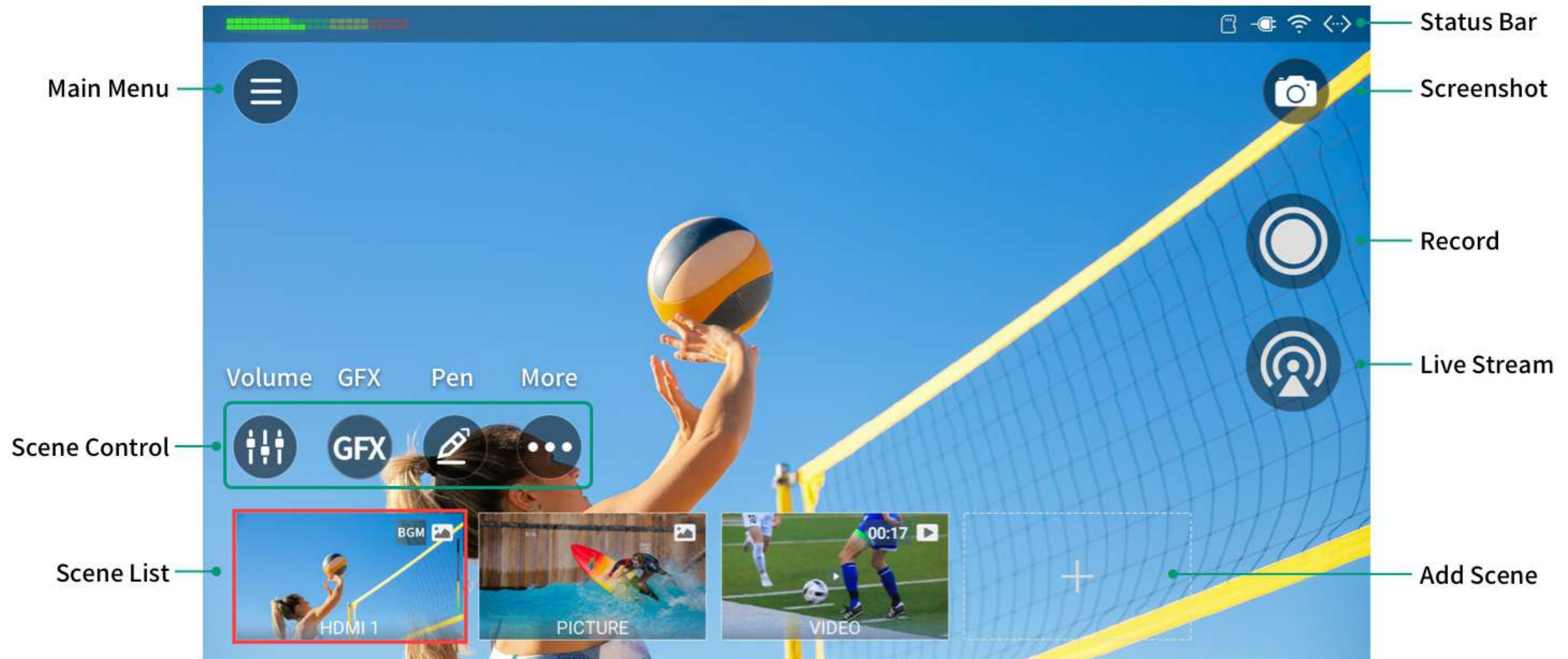

Main Screen

## Status Bar

The status bar helps you know the working status of the device.

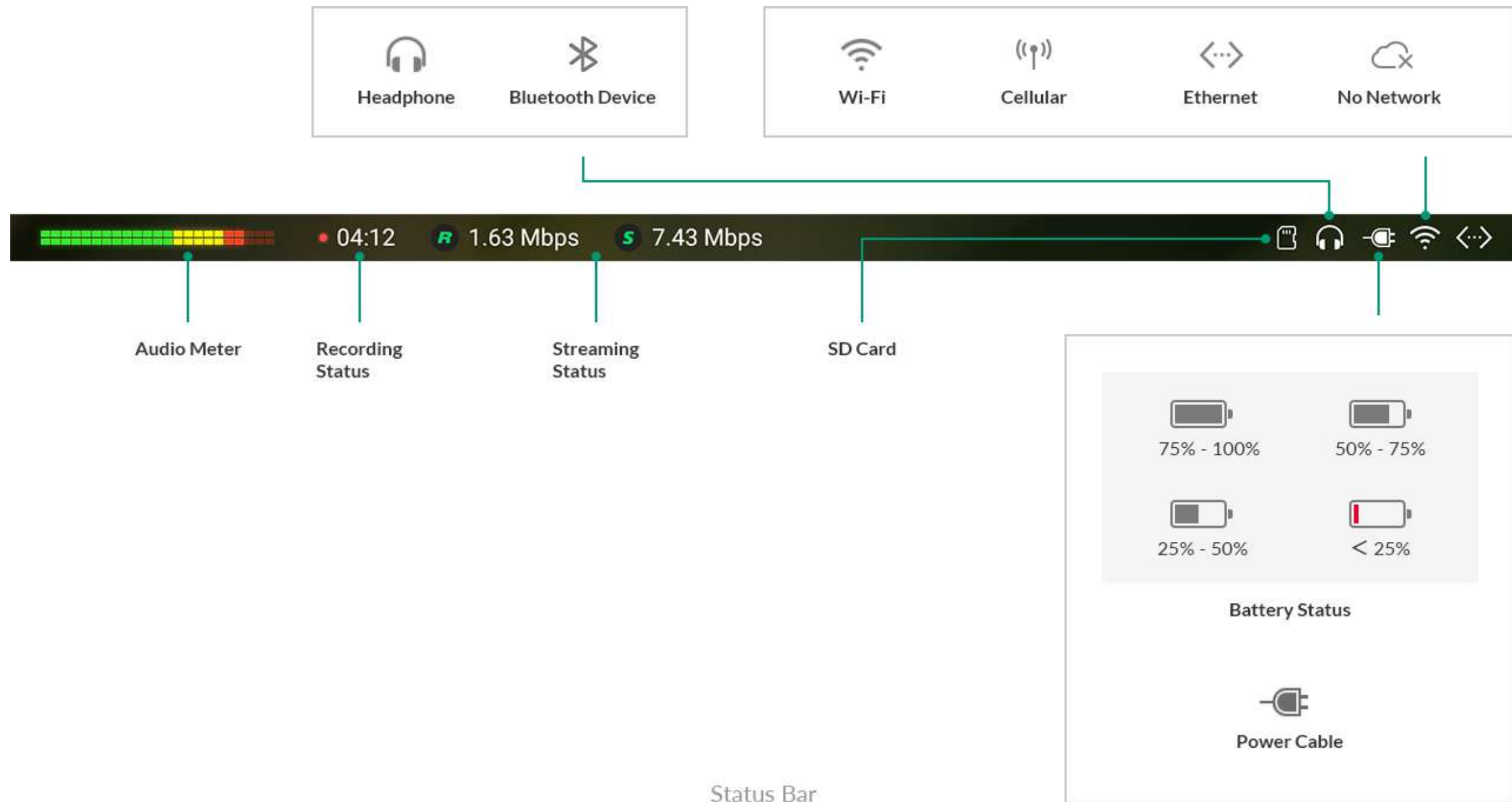

## Control Center

The control center provides more information of the device and enables quick settings. Swipe down the status bar to open the control center and swipe left/right for different pages. To close the control center, swipe up on the screen.

### General

Swiping down from the upper left, you can view following information or enable different functions.

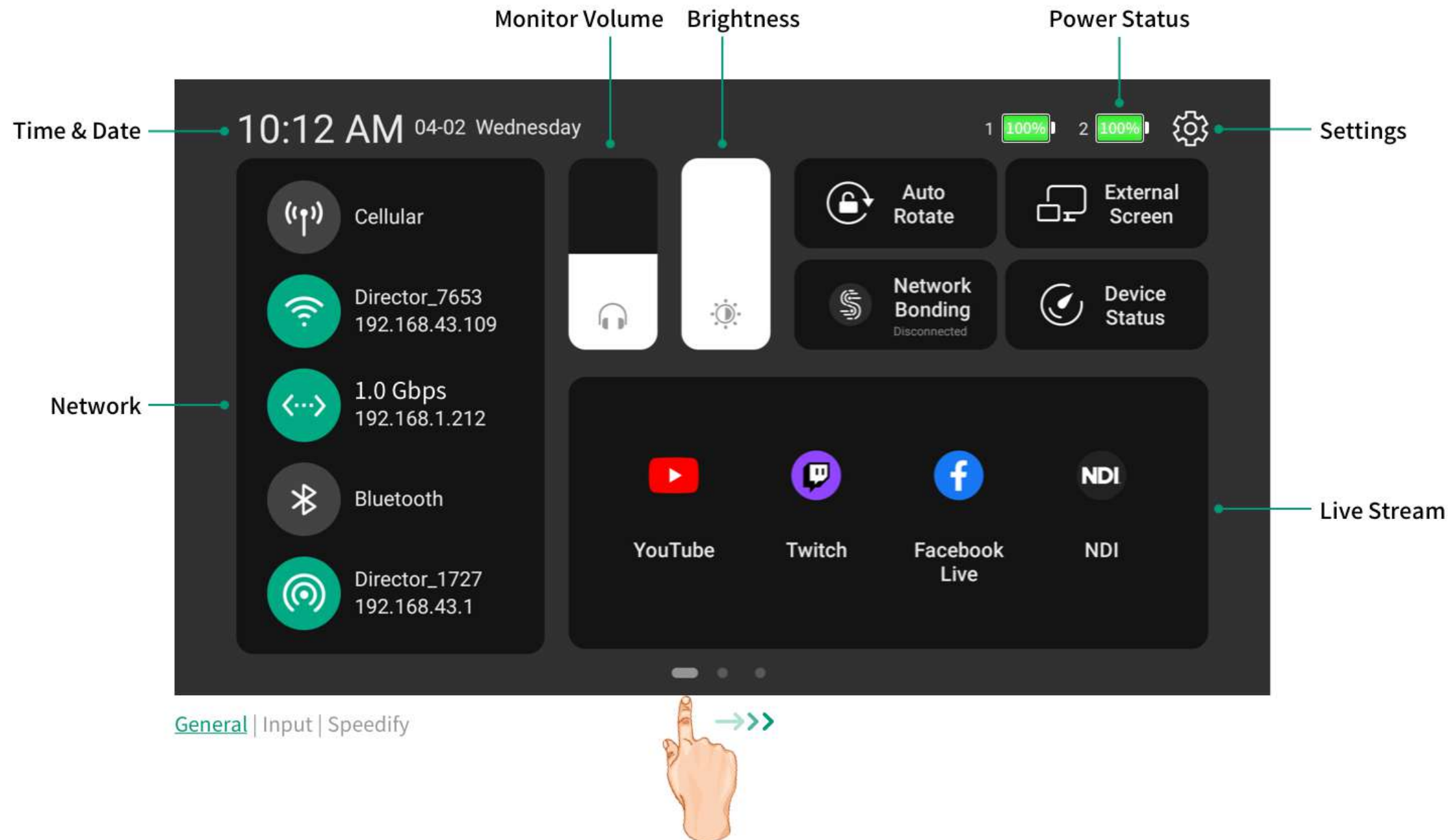



## Input Information

Swiping down from the top center, you can view the information of the input sources of current show, in which HDMI and WEBCAM are always displayed, while IP inputs and phone camera are displayed when they are added to scenes.

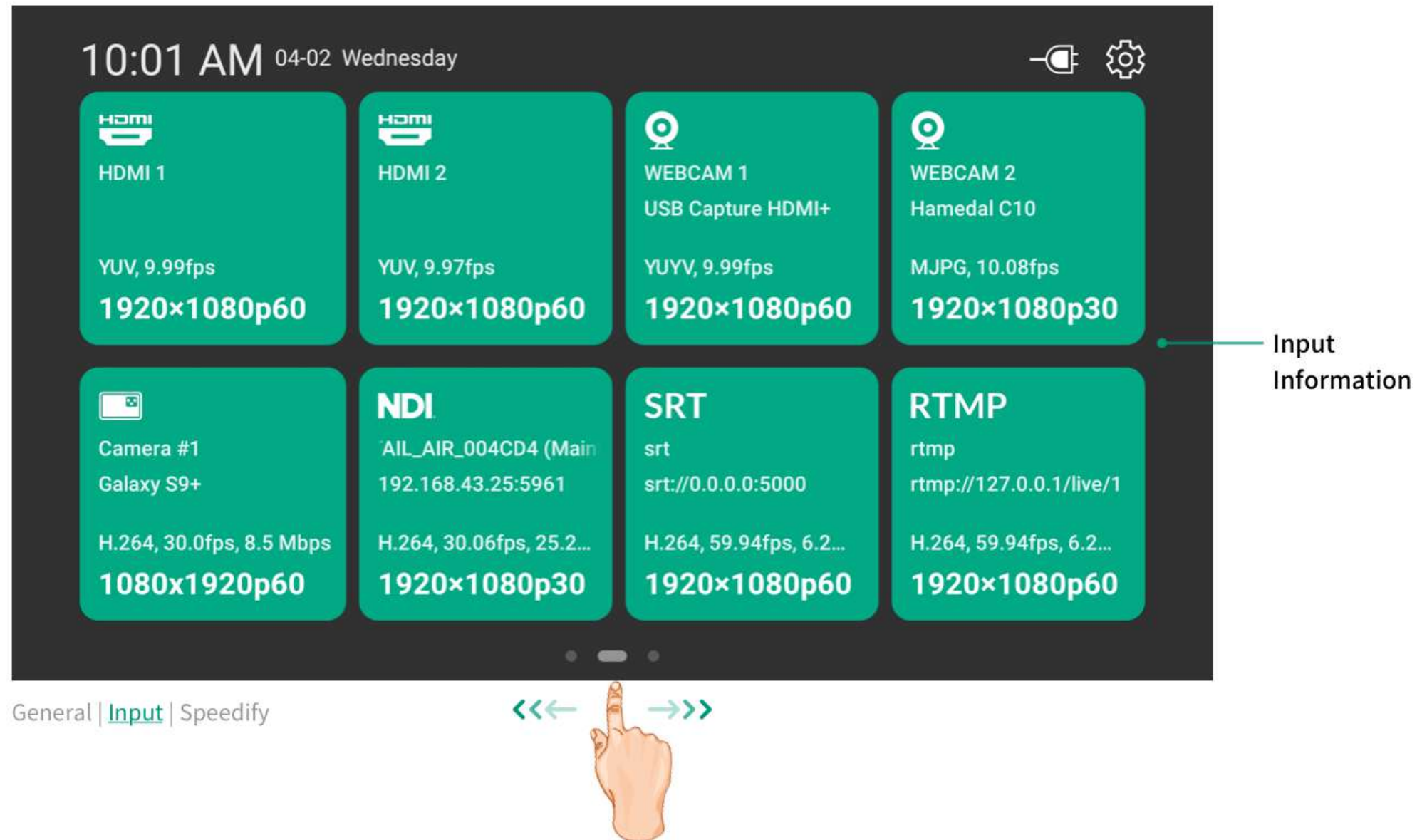

- **HDMI 1/2:** the input status of the HDMI 1/2 port
  - *Format:* the color format of HDMI input, such as YUV and RGB
  - *Real-time frame rate:* the real-time frame rate of HDMI input
  - *Resolution/frame rate:* the original resolution and frame rate of HDMI input, such as 1920x1080p60

- *Disconnected*: no input source connected.
- **WEBCAM 1/2**: the input status of WEBCAM 1/2
  - *Device name*: the device name of WEBCAM
  - *Format*: the video format of WEBCAM input, such as YUYV, NV12 and MJPEG
  - *Real-time frame rate*: the real-time frame rate of WEBCAM
  - *Resolution/frame rate*: the resolution and frame rate of WEBCAM which is set when you add the source in a scene, such as 1920x1080p60
  - *Disconnected*: no input source connected or added to a scene
- **NDI®**: the input status of NDI stream
  - *Stream name*: the name of NDI stream
  - *URL*: the URL of NDI stream
  - *Codec*: the codec information of NDI stream, such as H.264 and H.265
  - *Real-time frame rate*: the real-time frame rate of NDI stream
  - *Bitrate*: the real-time bitrate of NDI stream
  - *Resolution/frame rate*: the original resolution and frame rate of NDI stream
  - *Disconnected*: no NDI input signal
- **RTMP**: the input status of RTMP stream
  - *Stream name*: the name of RTMP stream
  - *URL*: the URL of RTMP stream
  - *Codec*: the codec information of RTMP stream, such as H.264
  - *Real-time frame rate*: the real-time frame rate of RTMP stream
  - *Bitrate*: the real-time bitrate of RTMP stream
  - *Resolution/frame rate*: the original resolution and frame rate of RTMP stream

- *Disconnected*: no RTMP input signal
- **SRT**: the input status of SRT stream
  - *Stream name*: the name of SRT stream
  - *URL*: the URL of SRT stream
  - *Codec*: the codec information of SRT stream, such as H.264 and H.265
  - *Real-time frame rate*: the real-time frame rate of SRT stream
  - *Bitrate*: the real-time bitrate of SRT stream
  - *Resolution/frame rate*: the original resolution and frame rate of SRT stream
  - *Disconnected*: no SRT input signal
- **RTSP**: the input status of RTSP stream
  - *Stream name*: the name of RTSP stream
  - *URL*: the URL of RTSP stream
  - *Codec*: the codec information of RTSP stream, such as H.264
  - *Real-time frame rate*: the real-time frame rate of RTSP stream
  - *Bitrate*: the real-time bitrate of RTSP stream
  - *Resolution/frame rate*: the original resolution and frame rate of RTSP stream
  - *Disconnected*: no RTSP input signal
- **Phone Camera**: the input status of phone camera
  - *Camera name*: the custom name of phone camera
  - *Phone name*: the custom name or model of your phone
  - *Codec*: the codec information of phone camera
  - *Real-time frame rate*: the real-time frame rate of phone camera

- *Bitrate*: the real-time bitrate of phone camera
- *Resolution/frame rate*: the original resolution and frame rate of phone camera which is set when you add the source to a scene.
- *Disconnected*: no phone camera input signal

## Speedify

Swiping down from the upper right, you can start Speedify network bonding and view uplink and downlink status.

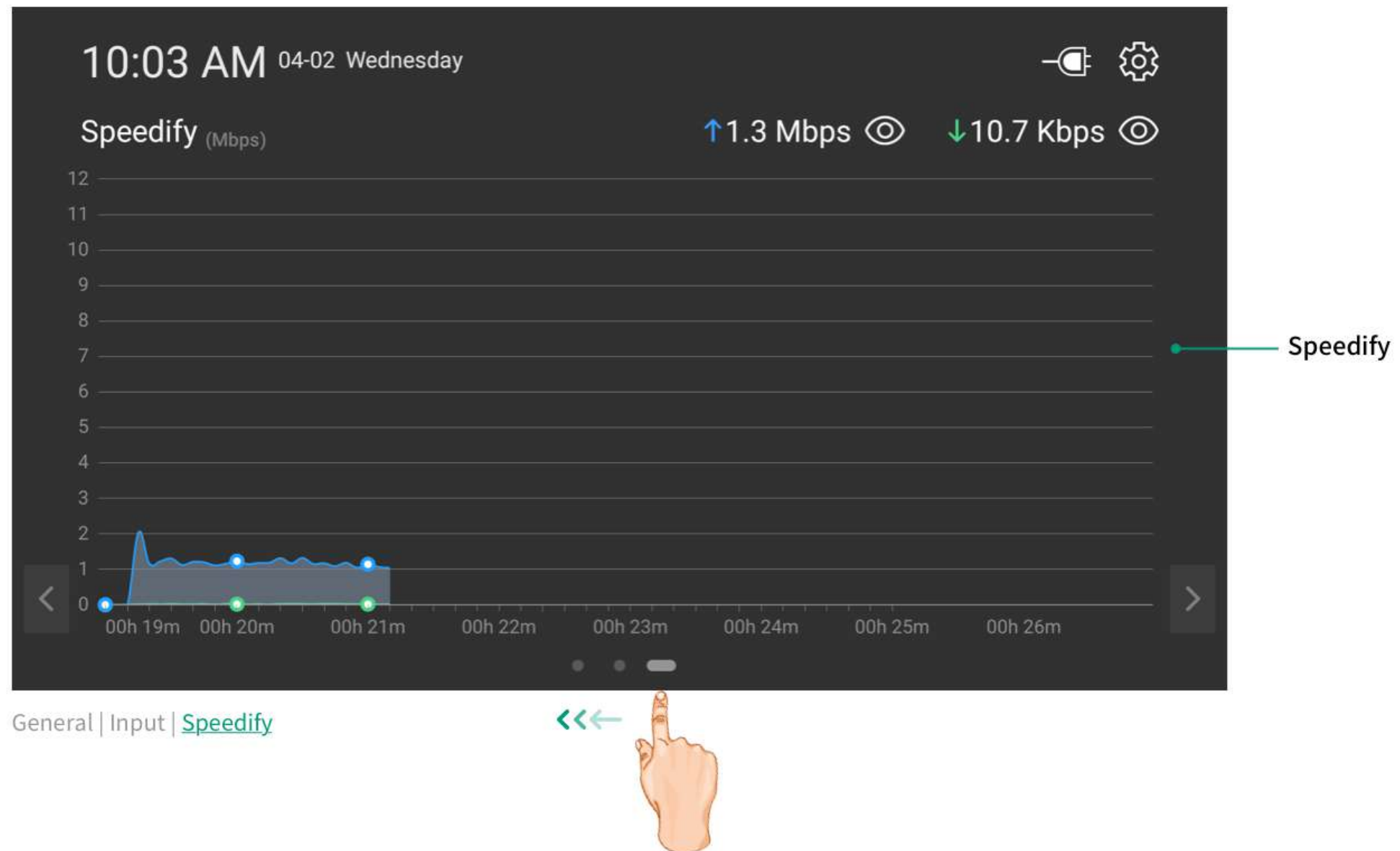

## Tutorials

The following tutorials will enable you to produce your first show and start to stream and record quickly.

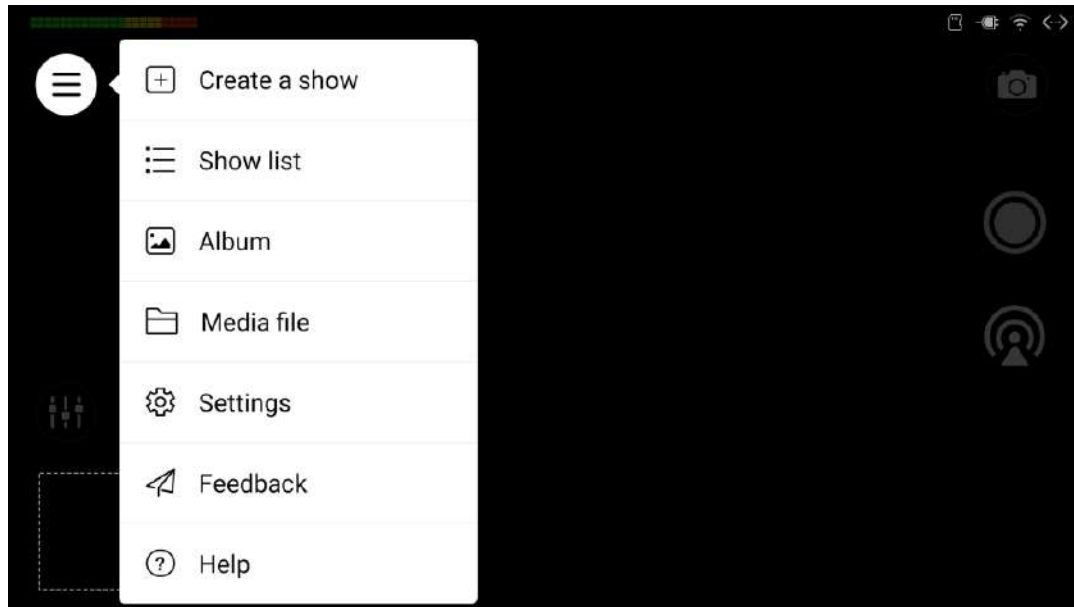

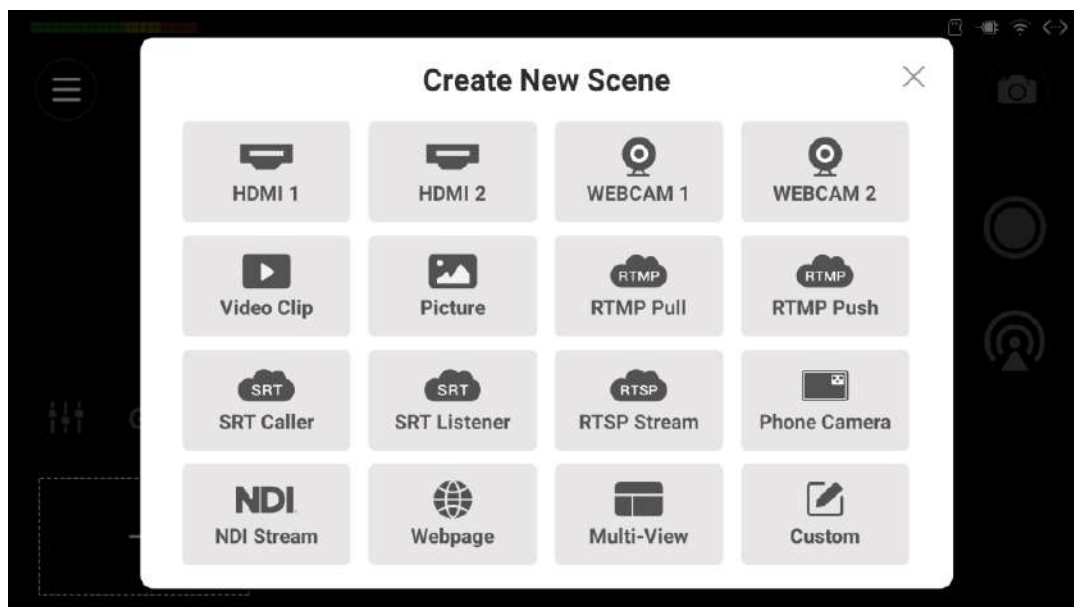

### Create Show

1. Tap  > **Create a show**.
2. Specify the **Show name** and **Frame rate**, and select the **Orientation** (16:9 or 9:16).
3. Tap **Create**.  
You will enter the new show.



### Create Scenes

1. Tap  on the screen.
2. In the **Create New Scene** window, select a source that you want to put into the new scene, and follow the popup to go on operating.
3. Edit the scene in the **Scene Editor**.
4. Save the changes you have made, and then the thumbnail of the new scene will be added to the end of the scene list.
5. Tap  to create more scenes.

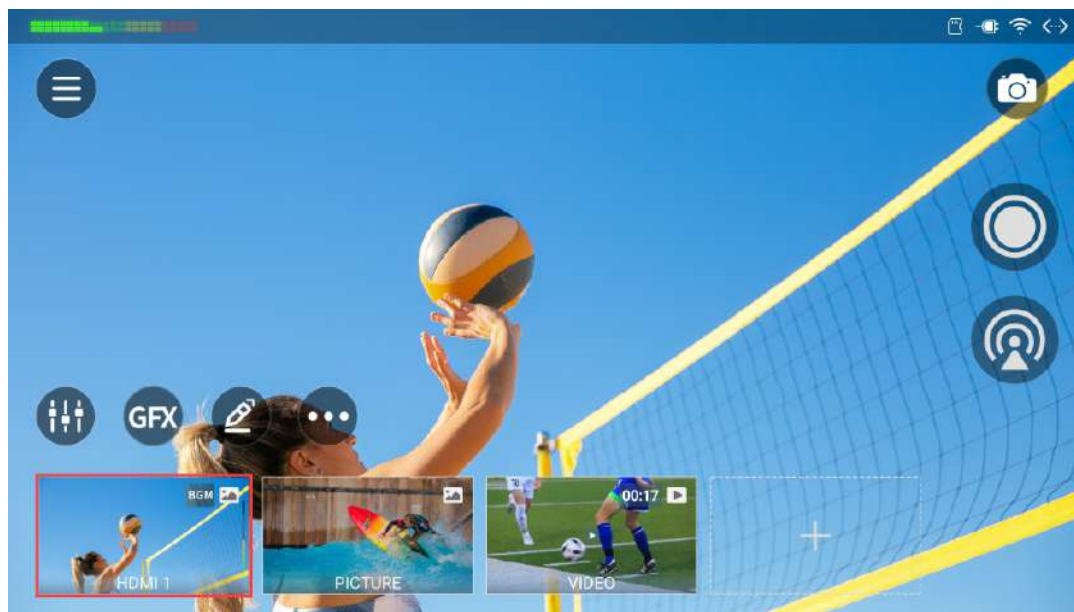

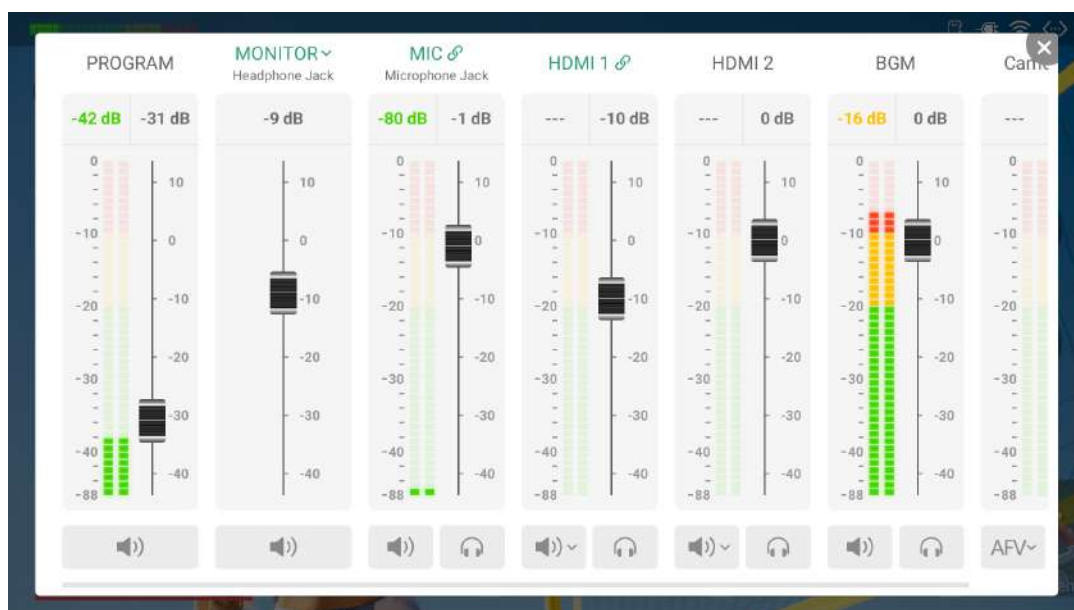

## Switch Scenes

- Swipe the scene list to left or right to browse scenes, and tap thumbnails to switch scenes.
- Tap any empty area of the screen to view the scene in full-screen mode, and tap any empty area again to exit the full-screen mode.
- If a scene contains a video clip source, you can tap the play and pause buttons to control the video.
- Swipe the scene list down to the bottom to hide it, and then you can tap  or swipe up from bottom to expand it.



## Adjust Volume

Tap  to open the audio mixer.

- Swipe left and right to view the connected audio sources and external audio sources. When the current scene contains video or BGM, they will also be displayed.
- Move the fader to adjust the audio level, and set the audio mixing mode by tapping the icon under the audio meter (in portrait mode, on the right).
- Tap  to only monitor this audio, and tap  to cancel.
- Tap **MONITOR** to select a monitor device, and set whether to monitor microphone input.

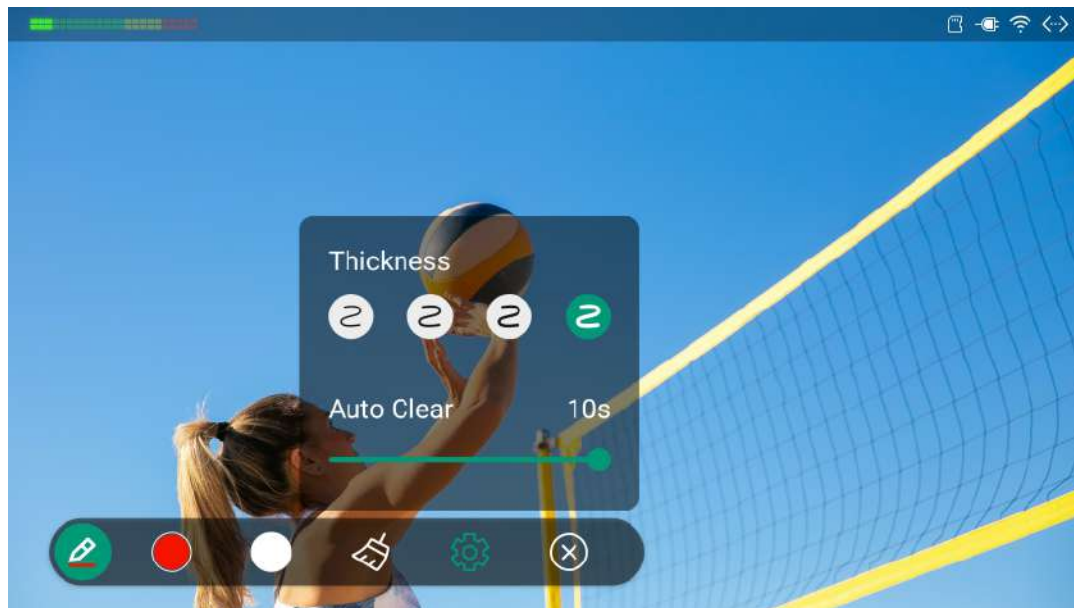
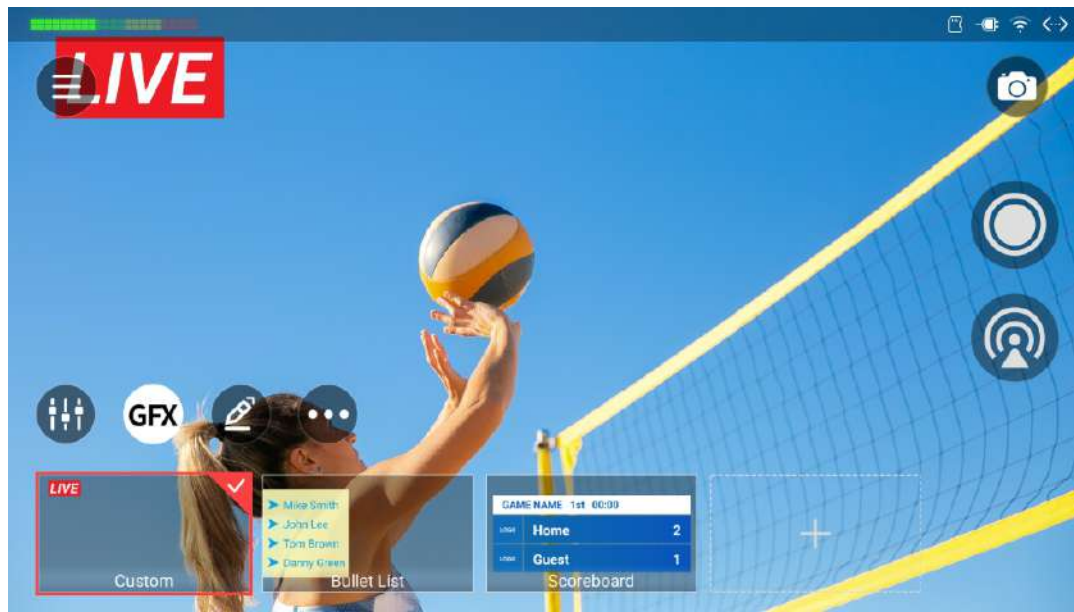

## GFX

1. Tap and then tap to open the **Create New GFX** window.
2. Select a GFX type to create a GFX.
3. Tap to create more GFXs.
4. Select one or more GFXs in the GFX list to display in the show.
5. When a scoreboard, timer or stopwatch is applied, you can open the control panel by tapping and selecting the corresponding button ( Scoreboard, Timer or Stopwatch) or by long-pressing the GFX thumbnail and selecting **Control**.
6. Tap to go back to the scene list.

## Annotate on Screen

1. Tap to enter the annotation mode.
2. Draw or write on the screen to annotate.
3. Tap to expand the toolbar.
  - Tap **Color 1** or **Color 2** to switch the pen color, and tap **Color 1** or **Color 2** again to set color for each.
  - Tap to clear the annotations.
  - Tap for to set pen thickness and auto clear time.
  - Tap to exit the annotation mode.

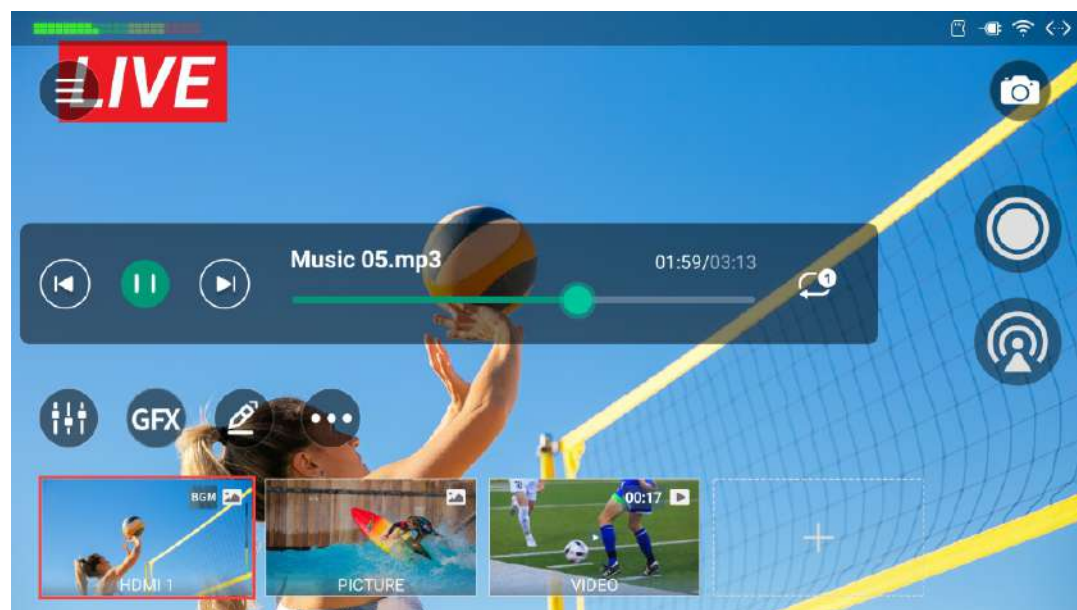
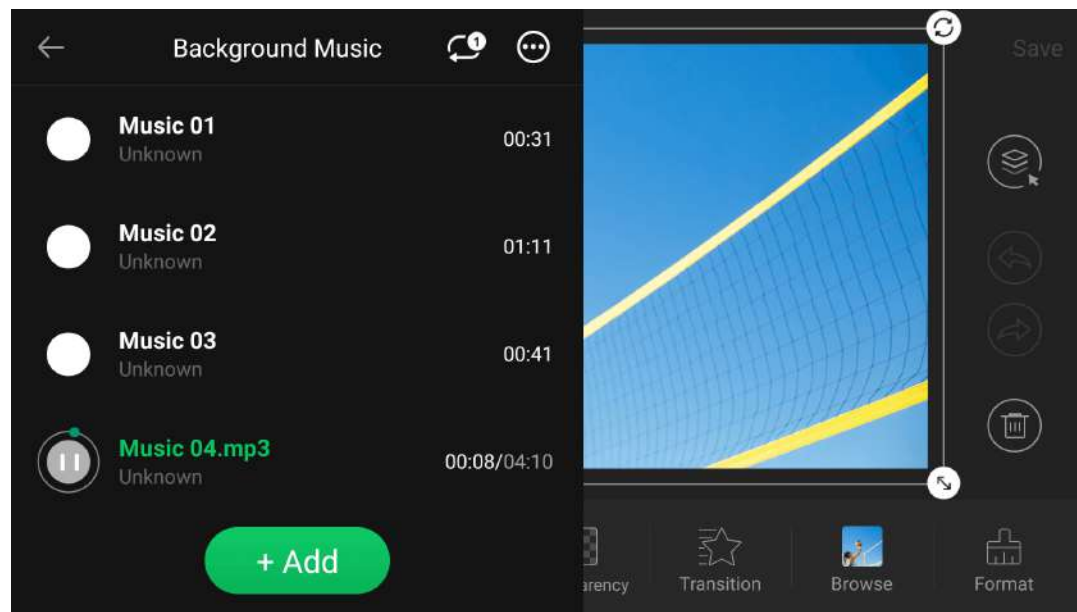





## Background Music

### Add BGM







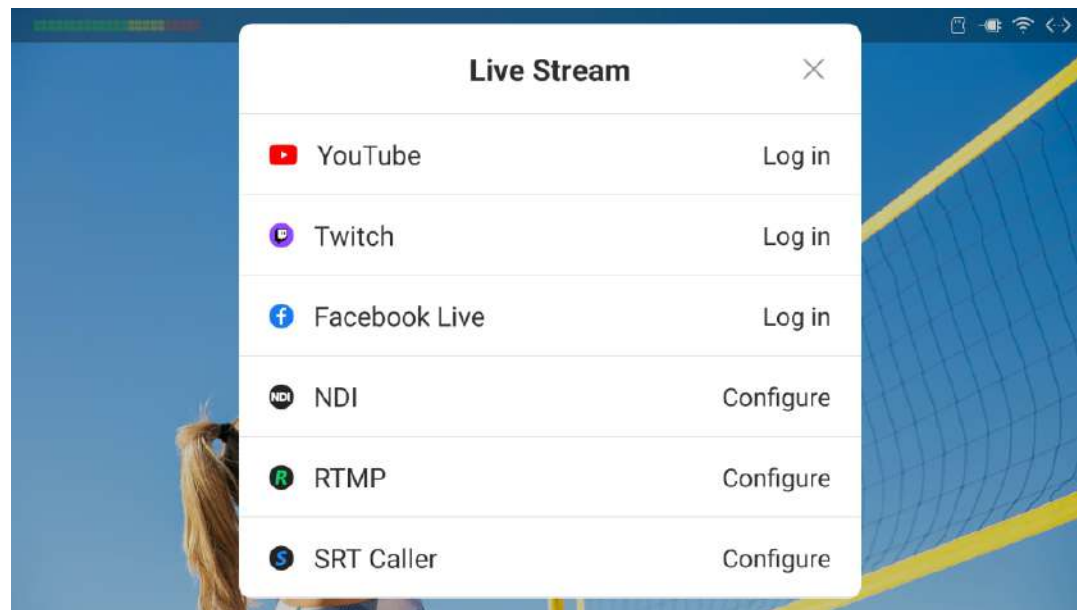

1. Long-press a scene thumbnail, and tap **Edit**.
2. In the Scene Editor, tap  to select a song from a storage path.
3. On the **Background Music** page, add more music and set playback policy and more actions by tapping the two buttons on the upper right corner.

### Control BGM

1. On the main screen, tap  >  **BGM** to reveal the BGM playback bar.
2. Tap the buttons on the playback bar to control the BGM playback. You can:
  - Start or stop BGM playback.
  - Play the previous or next song.
  - Drag the playhead to a desired time point.
  - Change the playback policies.
    -  : Repeat the playlist. (default policy)
    -  : Repeat the selected song.
    -  : Shuffle the playlist.



## Live Stream, Record and Screenshot

1. Tap  and select a target platform to configure, such as **RTMP**, and then tap  to go back.
2. Tap  to start streaming, tap  to start recording, and tap  to take screenshots of the program output.
3. Tap  >  to set and show live comments when streaming to YouTube, Twitch or Facebook. Long-press one comment to send it as an overlay.
4. Tap  to stop streaming, and tap  to stop recording.

# Produce Your Show

Director enables simple video production by allowing you to build a run of shows which contain a series of scenes, while each scene consists of live sources, video clips, images, text, etc.

## Create and Manage Shows

You can create and manage multiple shows in your Director device.

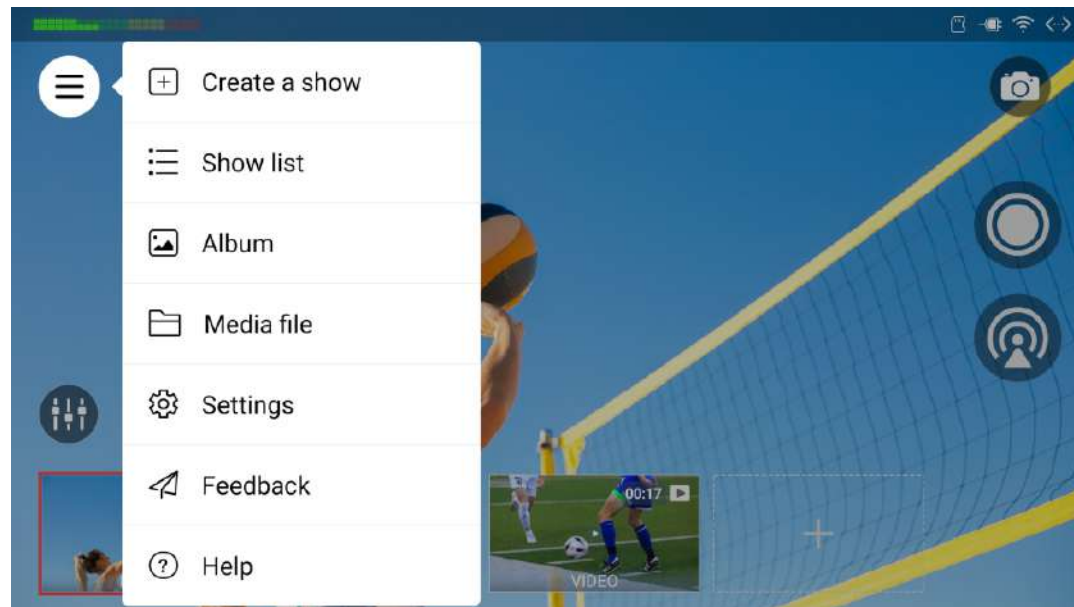

### Create Show

1. Tap  > **Create a show**.
2. Enter your show name, and then tap **Save**.
3. Select the frame rate. Options include 60/59.94/50/30/29.97/25/24/23.98 fps.
4. Choose the screen orientation: 16:9 (landscape), 9:16 (portrait).
5. Tap **Create**.

After you create a show, the show is opened as the current show.

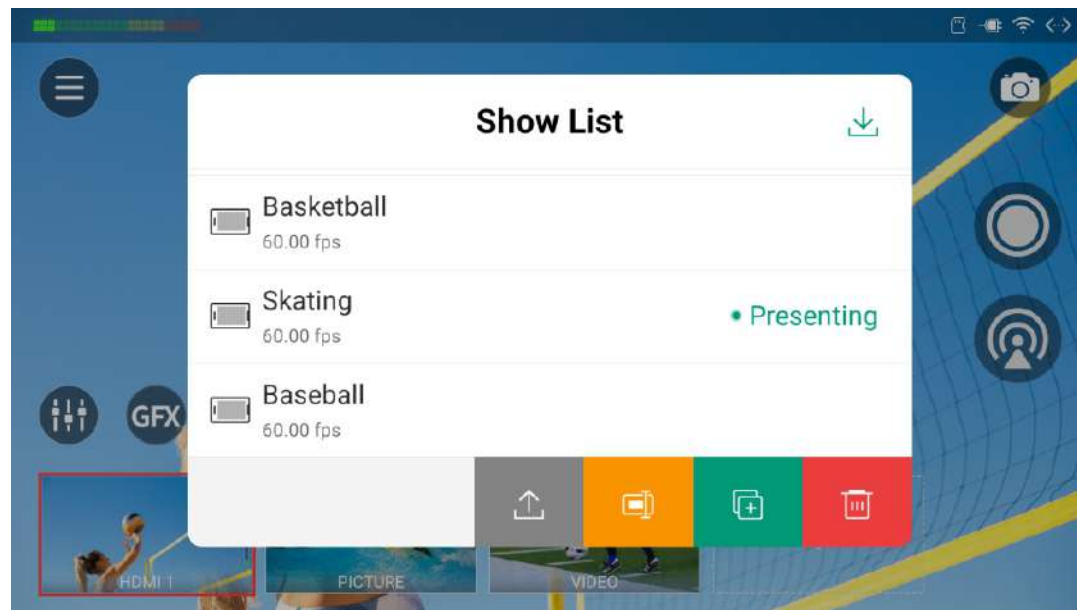



## Show List

The show list displays the name and frame rate of each show, through which you can switch and manages shows.



## Switch Show

1. Tap  > **Show list**.
2. Tap a show name to switch to the show.

## Rename Show



1. Tap  > **Show list**.
2. Swipe a show to the left.
3. Tap .
4. Enter a new name, and tap .

## Copy Show

1. Tap  > **Show list**.
2. Swipe a show to the left.
3. Tap .
4. Enter a new name, and tap .



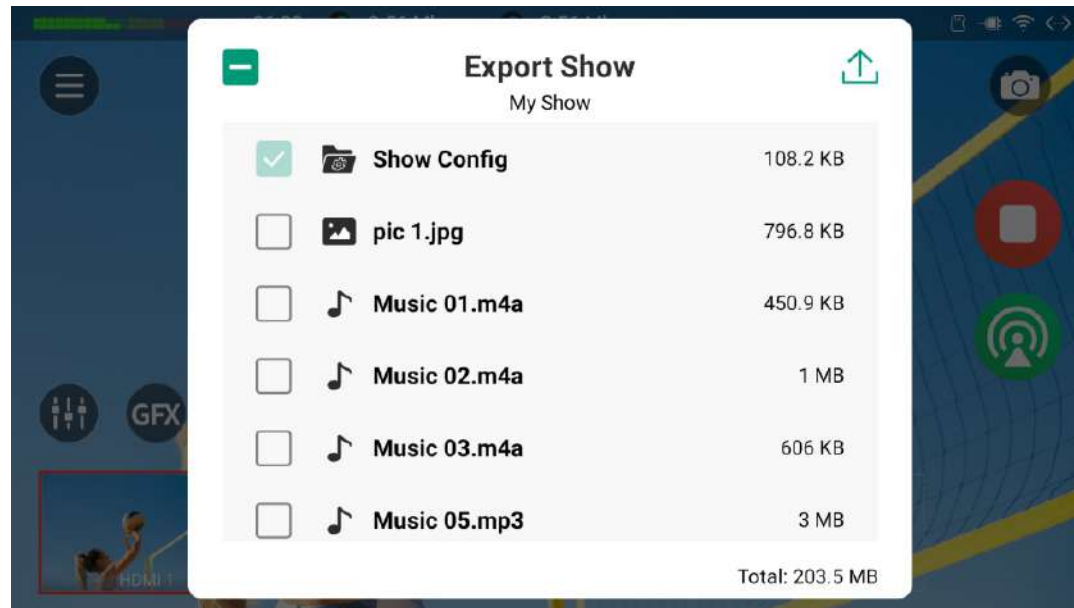

The new show you created inherits everything from the original show.

## Delete Show



1. Tap  > **Show list**.
2. Swipe a show to the left.
3. Tap , and confirm to delete on the popup.



## Export Show

1. Tap  > **Show list**.
2. Swipe a show to the left.
3. Tap .
4. Select the media files to export together with the Show Config file, or tap  to select all the files, and then tap .
5. Select USB flash drive or SD card to export. The show is exported as a .zip file.

## Import Show



1. Tap  > **Show list**.
2. Tap  at the upper right corner.
3. Select a show file (.zip) from the storage.

## Create and Manage Scenes

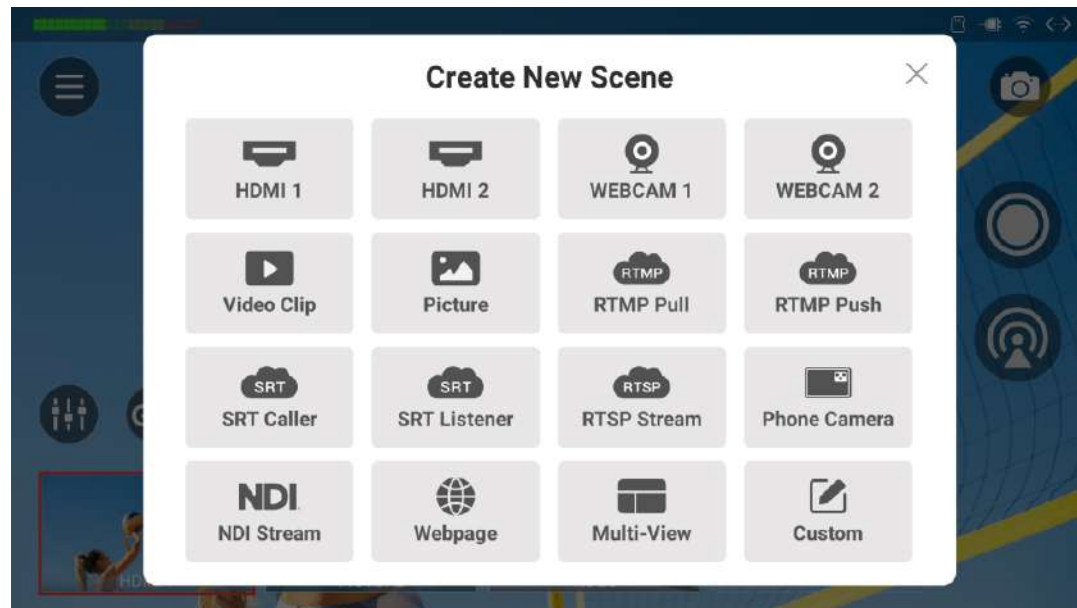
A show consists of one or more scenes, while a scene contains various sources, including HDMI input signal, webcam input signal, phone camera input signal, video clips, pictures, [RTMP/SRT/RTSP](#) streaming signal, webpages, NDI<sup>®</sup> input signal, etc.



### Create Scene

1. Tap **+** on the main screen.
2. Select a source in the **Create New Scene** window to add, and then it enters the Scene Editor page. For details about how to add different sources, see [Add Source](#).
3. To create a multi-view scene quickly, you can tap **Multi-View** option in the **Create New Scene** window to use the prebuilt layouts. For details, see [Add Multi-View Scene](#).
4. Edit the scene in the Scene Editor.  
Many tools are available for you to edit your scene, such as position, size, crop, transition. For details, see [Edit Scenes](#).
5. Tap  to add a private GFX for the scene. For details, see [Use GFX](#).
6. Tap  in the Scene Editor to set audio. For details, see [Volume Control](#).
7. Tap  in the Scene Editor to add background music (BGM). For details, see [Background Music](#).
8. Tap **Save** at the upper right corner.  
The scene thumbnail appears in the scene list.
9. Repeat the above steps to create more scenes.

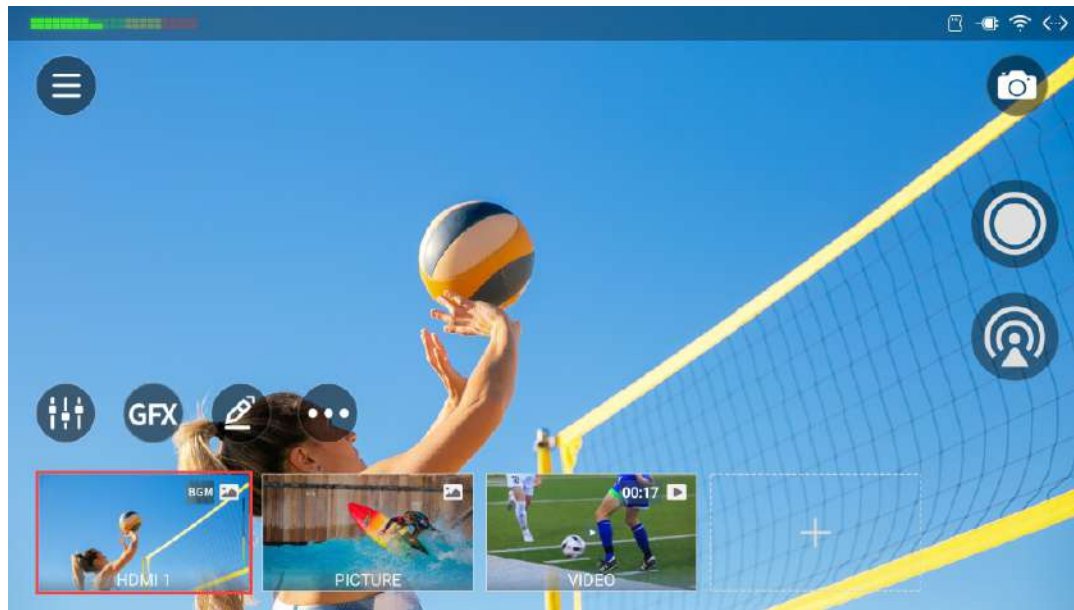



## Scenes

The scene list is displayed at the bottom of the main screen, and each scene has a corresponding thumbnail in the scene list.

The following information will be displayed on the thumbnail.

- A red box indicates which scene is in Program view.
- The scene name is displayed at the bottom.
- The layer type icon is displayed at the upper right corner: when there is only one layer in the scene, the type icon of the current layer is displayed; when there are multiple layers in the scene, an icon stack is displayed, and the icon at the front represents the uppermost layer.
- When the "BGM" icon is displayed, it means that the scene has added background music.
- When a scene contains phone camera source, the thumbnail displays the phone's battery level.

With the scene list, you can browse, switch, view the scene, and even edit and manage the scenes.

- Swipe the scene list left and right to browse the scenes.
- Swipe the scene list to the far right, and tap  to create a scene.
- Tap a thumbnail in the scene list to switch scenes. It supports quick mode and manual mode, please refer to [Switch Scenes](#).
- Long-press a thumbnail to manage the scene, or control PTZ, webpage or private GFX (if added).
- Tap any blank area to enter full-screen, and tap anywhere to exit. If no operation for three minutes, it will automatically enter the full-screen mode. Go to  > Settings > Display to set the duration of Auto Full Screen.

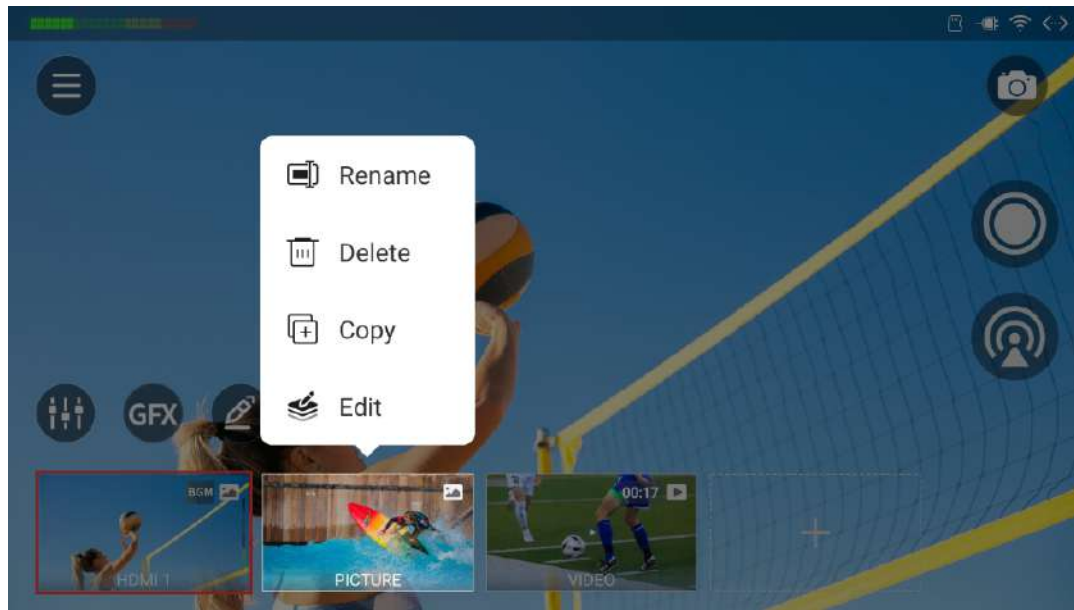

## Rename Scene

1. Long press a scene thumbnail.
2. Tap **Rename** on the popup menu.
3. Enter new scene name, and tap ✓.

## Delete Scene

You can delete a scene through the following ways.

### Method 1

1. Long press a scene thumbnail.
2. Tap **Delete** on the popup menu.
3. Confirm to delete on the popup.

### Method 2

1. Tap ⋮ on the main screen.
2. Select **Rearrange/Size** on the popup menu.
3. Tap the ⊗ button on a thumbnail, and then tap **Delete**.
4. Tap **Done** at the upper right corner.

A scene that is in Program view cannot be deleted. Switch to a different scene and then you can delete the desired scene.



## Copy Scene

You can also copy an existing scene to create a new scene by the following two ways.

Method 1:

1. Long press a scene thumbnail.
2. Tap **Copy** on the popup menu.
3. Enter new scene name, and tap .

Method 2:

1. Tap  on the main screen.
2. Select **Rearrange/Size** on the popup menu.
3. Tap  on the thumbnail of the scene you want to copy.
4. Enter a new name and tap .
5. Tap **Done** at the upper right corner to go back to the main screen.

## Edit Scene

1. Long press a scene thumbnail.
2. Tap **Edit** on the popup menu.
3. Edit the scene in the scene editor.



## Zoom Scene List

1. Tap on the main screen.
2. Select **Rearrange/Size** on the popup menu.
3. Tap or button on the right to change the size of thumbnails. It supports three sizes: small, middle and large. By default, the Scene List uses middle thumbnails.
4. Tap **Done** at the upper right corner.

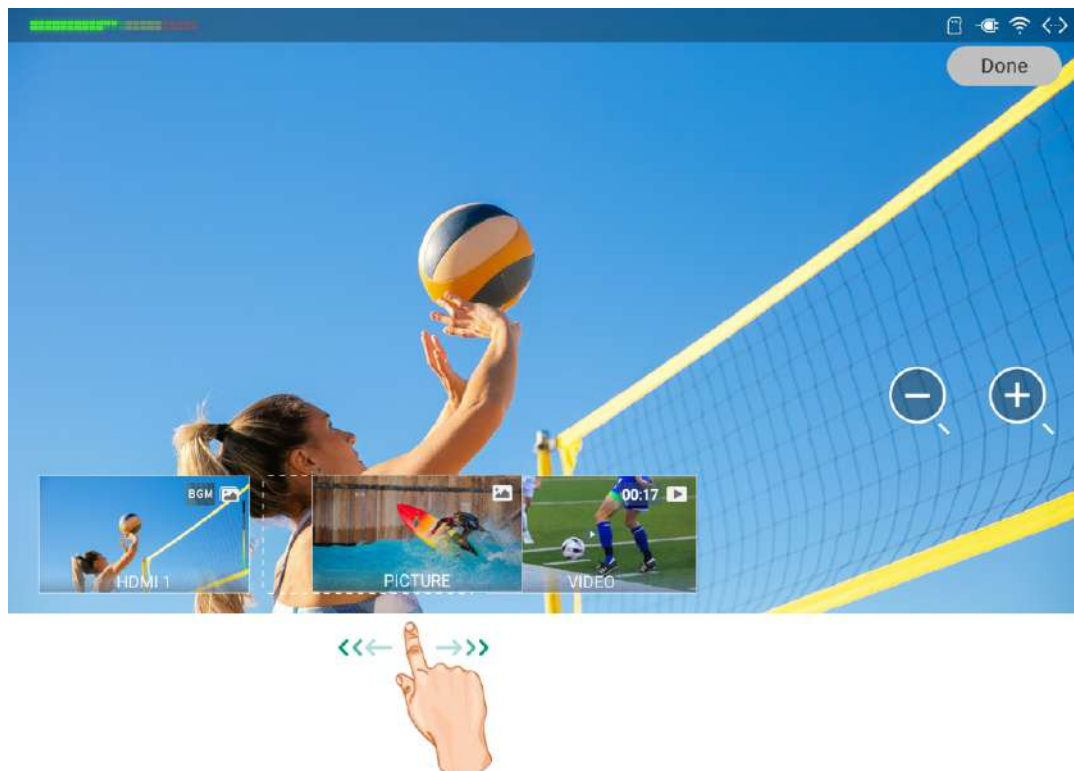

## Rearrange Scene Order

You can rearrange scene order by long-pressing a thumbnail and then drag it to a desired position in the scene list.

Besides, here is another method to rearrange scene order.

1. Tap on the main screen.
2. Select **Rearrange/Size** on the popup menu.
3. Long press a thumbnail and then drag it to a desired position in the scene list.
4. Tap **Done** at the upper right corner.



## Show or Hide the Scene List



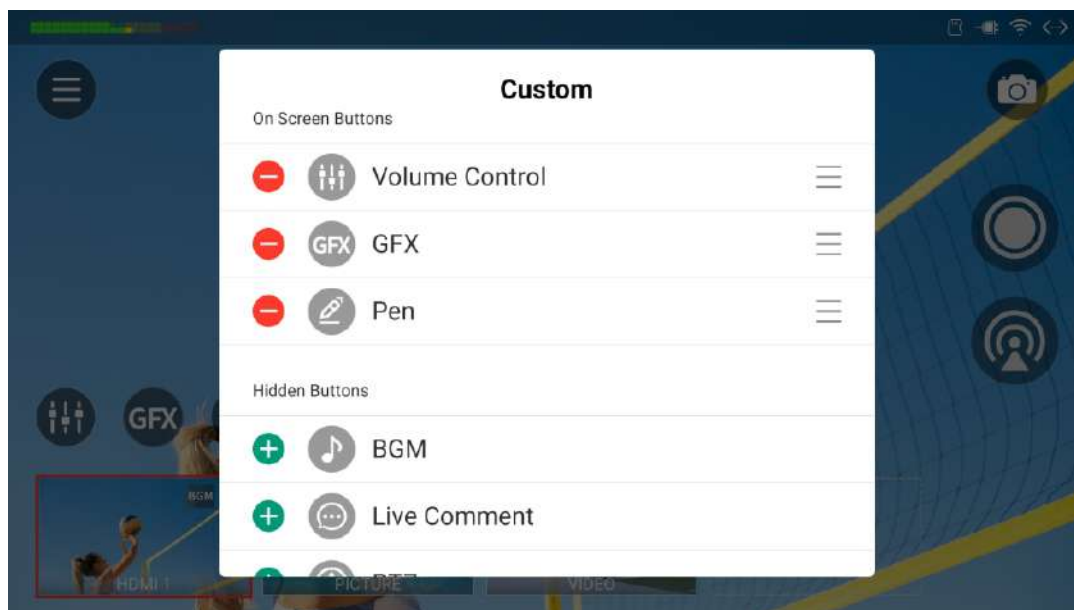

- When the Scene List is visible, swipe down to the bottom of the screen to hide it.
- When the Scene List is hidden, tap  or swipe up from bottom to expand it.

You can show or hide the GFX list through the same way.



## Customize Buttons

To focus on the task at hand, you may customize buttons appearing on the screen for each show.

1. Tap  on the main screen.
2. Tap **Custom**. Then it lists the displayed buttons and hidden buttons.
3. Tap  to add a button to the displayed buttons list.  
It supports displaying up to 6 buttons, including the  More button which is always displayed.
4. Press and hold , and drag up and down to change a button's display order.
5. To hide a button, tap  or swipe the button to left and then tap **Remove**.
6. Tap the blank space to exit.

## Edit Scenes

Sources are the building blocks of scenes. You can fill a scene with a combination of various sources such as HDMI, WEBCAM, [RTMP Pull](#), [RTMP Push](#), [SRT Caller](#), [SRT Listener](#), [RTSP stream](#), NDI<sup>®</sup>stream, Webpage, Video, Picture and Text. With the rich sources on hand, creativity is unlimited. You will use the Scene Editor to plan out your scene and add eye-catching effects to your sources.

The following picture illustrates the elements on the Scene Editor. This picture is in landscape mode, and some buttons will change positions in portrait mode.



Scene Editor

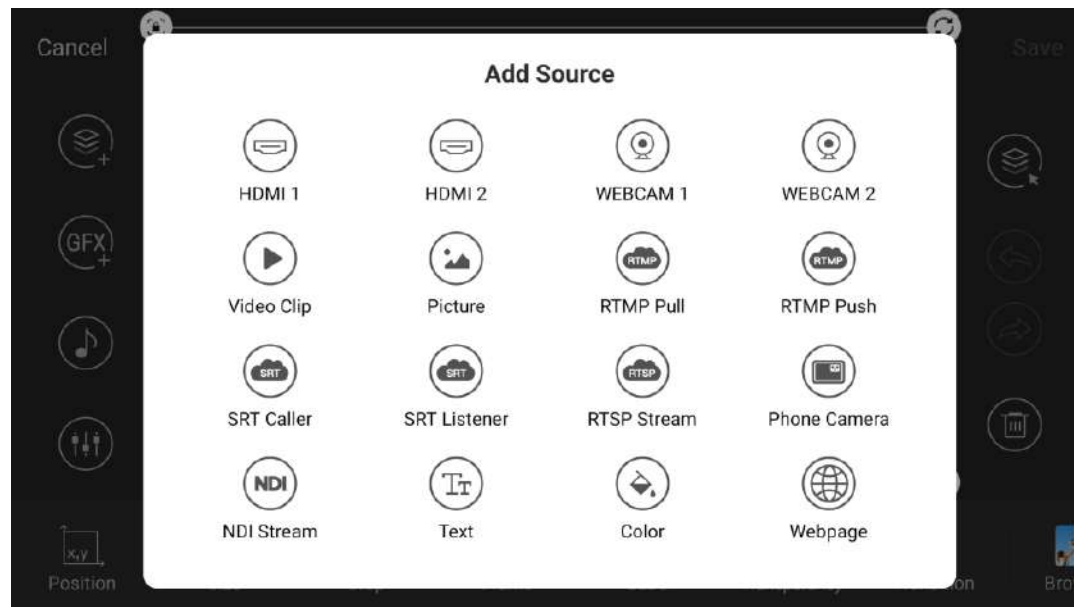

## Add Source

You can add multiple sources in one scene, and then you can arrange the layout to look the way that you want.

1. Long press a scene thumbnail and then tap **Edit** to open the Scene Editor.
2. Tap  in the Scene Editor.
3. Scroll up and down and tap a source in the **Add Source** window:

- **HDMI**

A high-quality external signal from a professional camera, computer, game console, etc. Up to 4K signal input is supported.

- **WEBCAM**

A high-quality external signal from a USB device, such as webcam. Up to 1080p60 signal input is supported. For details, refer to [Add WEBCAM](#).

- **Video Clip**

A video file selected from the internal storage, SD card or USB flash drive, which can be up to 4K, encoded in H.264, and in MOV, MP4, WebM or MKV format. Besides, you can select 2 to 100 videos to enable a video slide show.

If you upload a MOV file in ProRes 4444 format, it will be automatically converted to the WebM format to enhance performance.

To select files from the internal storage, you should import files to Director device at first. Please refer to [How to import/export files](#).

- **Picture**

A picture file selected from the internal storage, SD card or USB flash drive, which can be JPG, PNG or BMP. Besides, you can select 2 to 100 pictures to enable a picture slide show.

To select files from the internal storage, you should import files to Director device at first. Please refer to [How to import/export files](#).

- **RTMP Pull**  
A streaming source pulled via [RTMP](#) from a third-party server. Please refer to [Add RTMP Pull](#).
- **RTMP Push**  
A streaming source pushed to Director device via [RTMP](#). Please refer to [Add RTMP Push](#).
- **SRT Caller/Listener**  
A streaming source supporting [SRT](#) protocol. Please refer to [Add SRT Caller/Listener](#).
- **RTSP**  
A streaming source pulled via [RTSP](#). Please refer to [Add RTSP Stream](#).
- **Phone Camera**  
A camera signal from the phone installed with the Director Utility App. You can [Add Phone Camera](#) at first, and then use your phone to connect the device.
- **NDI® Stream**  
A streaming source pulled via [NDI® HX2](#), [NDI® HX3](#) or [Full NDI®](#). Please refer to [Add NDI Stream](#). It supports H.264 and H.265 codec.
- **Webpage**

The content of a webpage. Please refer to [Add Webpage](#).

- **Text**

Static annotations and crawling messages.

Tap the text frame to enter content, and tap Save to return to the Scene Editor.

A maximum of 1024 characters are supported. The more text, the smaller the font appears. The font size also changes automatically with the text box size.

- **Color**

A solid color source. It is white by default.

**Notice:**

- **In the same scene**, you can add up to three kinds of video sources, including HDMI, WEBCAM, [RTMP/SRT/RTSP](#) stream, NDI Stream, Phone Camera and video clips, in which:
  - Each source can be added repeatedly except the video clip.
  - You can only add one video layer, which can be a single video or a video slide show.
  - If a video layer is added, you cannot add a picture slide show, vice versa.
- **In the same scene**, you can only add one webpage.
- **In the same show**, you can create up to 3 streams, including [RTMP/SRT/RTSP/NDI](#). One NDI stream cannot be use by a scene and a GFX at the same time.
- **In the same show**, you can create up to 3 Phone Cameras.

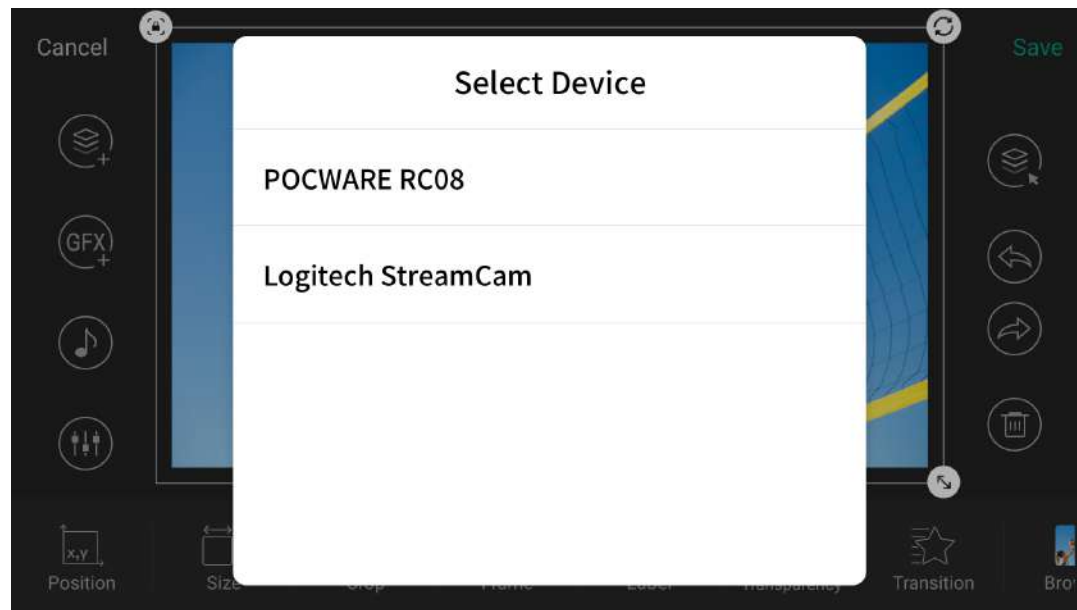

## Add WEBCAM

1. Tap  in the scene editor.
2. Select **WEBCAM 1** or **WEBCAM 2**.
3. Bind a webcam device to WEBCAM 1 or WEBCAM 2 according to the following situations.
  - If one USB device is connected, choose **WEBCAM 1**, then the device will be bound with WEBCAM 1 automatically. When you add **WEBCAM 2**, no-signal screen will be displayed, vice versa.
  - If two or more USB devices are connected, when adding **WEBCAM 1** or **WEBCAM 2**, please select a device on the popup to bind.

You can refer to [Changing WEBCAM's Properties](#) to select or change the USB device bound to WEBCAM 1 or WEBCAM 2 as well set the WEBCAM's property.

**Create RTMP Pull**

Name:

URL:

Key:

Advanced

Cancel Create

---

**Create RTMP Pull**

Advanced

Buffer duration:  ms

Authentication:

Username:

Password:

Cancel Create

## Add RTMP Pull

1. Tap  in the Scene Editor, and select **RTMP Pull**.
2. Enter the following information.
  - **Name:** Specify an alias name for your convenience of multi-item management.
  - **URL:** Enter the **RTMP** URL of the **RTMP** server. To add a video stream from a live platform, you can get the **RTMP** URL from the platform.
  - **Key:** Enter the key set on the **RTMP** server.
3. (Optional) Tap **Advanced** to set the following parameters.
  - **Buffer duration:** It ranges from 20ms to 8000ms, and the default value is 60ms. You can set a short duration when low latency matters.
  - **Authentication:** If the **RTMP** sender requires authentication, toggle on **Authentication** and enter **Username** and **Password** provided by the **RTMP** sender.
4. Tap **Create**.
5. To add more **RTMP** streams, repeat step 1 and 2, tap **Create Stream**, and operate as step 3 to 5 to finish creation.
6. After a stream is added, its information is saved in the show. You can select an existing stream when you create a new scene or add a source to a scene.
7. To edit a stream, you can use the **URL** tool in the scene editor. For details, please refer to [URL](#).
8. To delete a stream, you can delete all the scenes containing this stream, or delete the stream source in all the relative scenes.

**Create RTMP Push**

Name:

Key:

Buffer duration:  ms

rtmp://10.10.12.127/live/123  
 rtmp://192.168.67.227/live/123

Cancel
Create

## Add RTMP Push

As is to send **RTMP** streams to Director device, the IP address of Director device is the destination.

1. Tap  in the Scene Editor, and select **RTMP Push**.
2. Enter the following information.
  - **Name:** Specify an alias name for your convenience of multi-item management.
  - **Key:** Specify a stream key.
  - **Buffer duration:** It ranges from 20ms to 8000ms, and the default value is 60ms. You can set a short duration when low latency matters.

A stream address is automatically generated at the bottom of the window, including an Ethernet address and/or a wireless network address. The sender should use this address as the destination address.

3. Tap **Create**.
4. To add more **RTMP** streams, repeat step 1 and 2, tap **Create Stream**, and operate as step 3 to 4 to finish creation.
5. After a stream is added, its information is saved in the show. You can select an existing stream when you create a new scene or add a source to a scene.
6. To edit the stream, you can use the **URL** tool in the scene editor. For details, please refer to [URL](#).
7. To delete a stream, you can delete all the scenes containing this stream, or delete the stream source in all the relative scenes.

**Create SRT Caller**

Name: 1-32 characters

Address: IP address or domain name

Port: 1-65535

Stream ID: 0-256 characters

Advanced

Cancel Create

**Create SRT Caller**

Stream ID: 0-256 characters

Advanced

Latency: 120 ms

Buffer duration: 60 ms

Encrypted:

Cancel Create

**Create SRT Listener**

Name: 1-32 characters

Address: 0.0.0.0

Port: 1-65535

Advanced

Cancel Create

**Create SRT Listener**

Port: 1-65535

Advanced

Latency: 120 ms

Buffer duration: 60 ms

Encrypted:

Cancel Create

## Add SRT Caller/Listener

1. Tap  in the Scene Editor.
2. Tap **SRT Caller** or **SRT Listener**.
3. Enter the following information.
  - **Name:** Specify an alias name for your convenience of multi-item management.
  - **Address:** Available for **SRT Caller**. If the **SRT** listener and caller are on the same LAN, enter the private IP address of the **SRT** listener on the LAN. If the **SRT** listener and caller are in different network environments, enter the public IP address of the **SRT** listener.
  - **Port:** Enter the port of the source. It ranges from 1 to 65535.
  - **Stream ID:** Available for **SRT Caller**. Enter the stream ID of the listener, which can contain 0 to 256 characters. You can leave it empty if the listener has no stream ID.
4. (Optional) Tap **Advanced** to set the following parameters.
  - **Latency:** Enter a number between 20 to 8000. The default value is 120. It is recommended that the latency is configured the same as that of the source.
  - **Buffer duration:** The value ranges from 20ms to 8000ms. The default value is 60ms. You can set a short duration when low latency matters.
  - **Encrypted:** If the stream from the source is encrypted, toggle on **Encrypted**, select the encryption mode, which can be **AES 128**, **AES 192** or **AES 256**, and then enter the **Passphrase**.
5. Tap **Create**.

6. To add more [SRT](#) streams, repeat step 1 and 2, tap **Create Stream**, and operate as step 3 to 5 to finish creation.
7. After a stream is added, its information is saved in the show. You can select an existing stream when you create a new scene or add a source to a scene.
8. To edit a stream, you can use the **URL** tool in the scene editor. For details, please refer to [URL](#).
9. To delete a stream, you can delete all the scenes containing this stream, or delete the stream source in all the relative scenes.

**Create RTSP Stream**

Name:

URL:

Buffer duration:

TCP first:

## Add RTSP Stream

1. Tap  in the Scene Editor, and select **RTSP Stream**.
2. Enter the following information.
  - **Name:** Specify an alias name for your convenience of multi-item management.
  - **URL:** Enter the **RTSP** URL. The URL syntax is `rtsp://[username:password@]IP-address:port/path`, where "username:password@" is optional which is required only if the streaming server demands authentication, "IP-address" is the IP address of the streaming server, "port" is the port number of the streaming server, and "path" is the path on the server that identifies the media resource.
  - **Buffer duration:** The value ranges from 20ms to 8000ms. The default value is 60ms. You can set a short duration when low latency matters.
  - **TCP first:** It is disabled by default, which means that the device will attempt to establish a connection with the **RTSP** server using the UDP protocol first. If it fails, it will then switch to TCP. When it is enabled, the device will first attempt to use TCP for communication. If it fails, it will then try to use UDP instead.
3. Tap **Create**.
4. To add more **RTSP** streams, repeat step 1 and 2, tap **Create Stream**, and operate as step 3 to 5 to finish creation.
5. After a stream is added, its information is saved in the show. You can select an existing stream when you create a new scene or add a source to a scene.

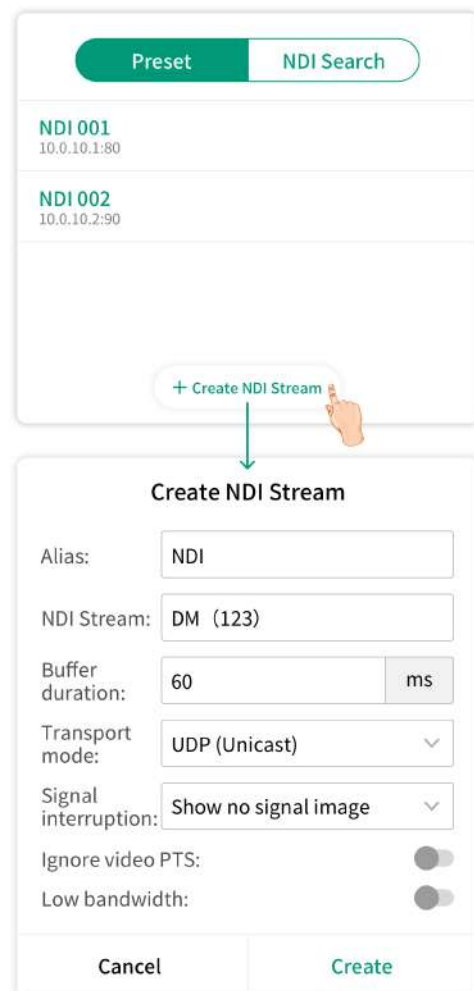

6. To edit a stream, you can use the **URL** tool in the scene editor. For details, please refer to [URL](#).
7. To delete a stream, you can delete all the scenes containing this stream, or delete the stream source in all the relative scenes.

## Add NDI Stream

### Add NDI Stream Manually

1. Tap  in the Scene Editor.
2. Tap **NDI Stream**.
3. Tap the **Preset** tab, and then tap **Create NDI stream**.
4. Enter the following information.
  - **Alias:** Specify an alias name for your convenience of multi-item management.
  - **NDI stream:** Enter the stream name of NDI source, which is case-insensitive, or enter IP:Port.
  - **Buffer duration:** The value ranges from 20ms to 8000ms. The default value is 60ms. You can set a short duration when low latency matters.
  - **Transport mode:** Options include UDP (Unicast), UDP (Multicast), RUDP (Unicast), TCP (Uni-connection) and TCP (Multi-connection).
  - **Signal interruption:** Select to show no signal image or show last frame when NDI signal is interrupted.
  - **Ignore video PTS:** For some video streams with wrong timestamps, toggle on this function to ensure smooth video output.
  - **Low bandwidth:** It is recommended to enable this function when the

connected network speed is too low to output smooth video. When toggled on, the video stream drops to medium quality and uses significantly less bandwidth.

5. Tap **Create** to add the stream to the scene.
6. Repeat the steps above to create more NDI streams.  
When multiple NDI streams are created, you can select one to add to a scene.
7. To edit an existing NDI stream, swipe the stream to the left, and tap **Edit**.
8. To delete an existing NDI stream, swipe the stream to the left, and tap **Delete**.

If a NDI stream is in one or more scenes, it cannot be deleted. Please delete the source in relative scenes at first, and then delete it.

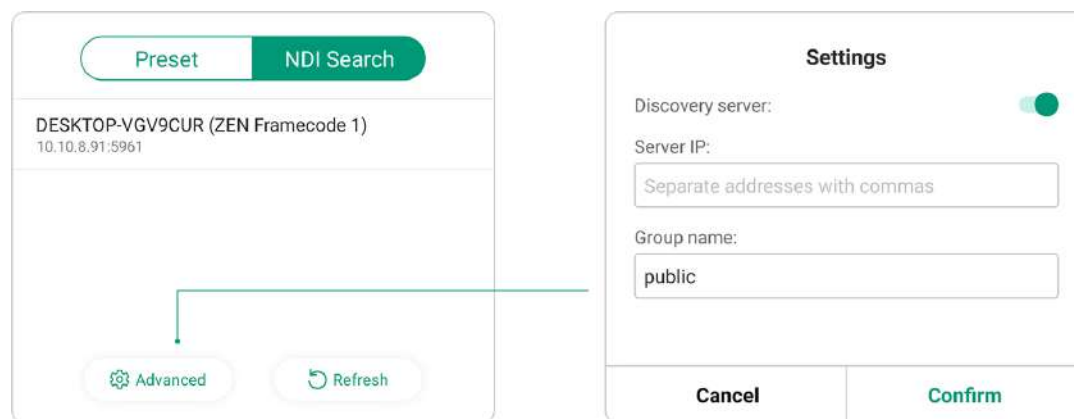

### Search NDI Stream Automatically

1. Tap  in the Scene Editor.
2. Tap **NDI Stream**.
3. Tap **NDI Search**, and it starts searching NDI sources in the same LAN. By default, it searches NDI sources of the public group.
4. Tap **Advanced**, enter **Group name**, and tap **Confirm**. Then it starts searching sources in corresponding group(s).  
Group name is case-insensitive, and should contain A to Z, a to z, 0 to 9 and special characters like \_-. The group name entry can contain comma-separated values, allowing the device search all the groups listed here.
5. If you toggle on **Discovery server**, it can auto-detect a source sender in different network segment but be able to ping. And the Server IP should be the IP address of the server running discovery server software.

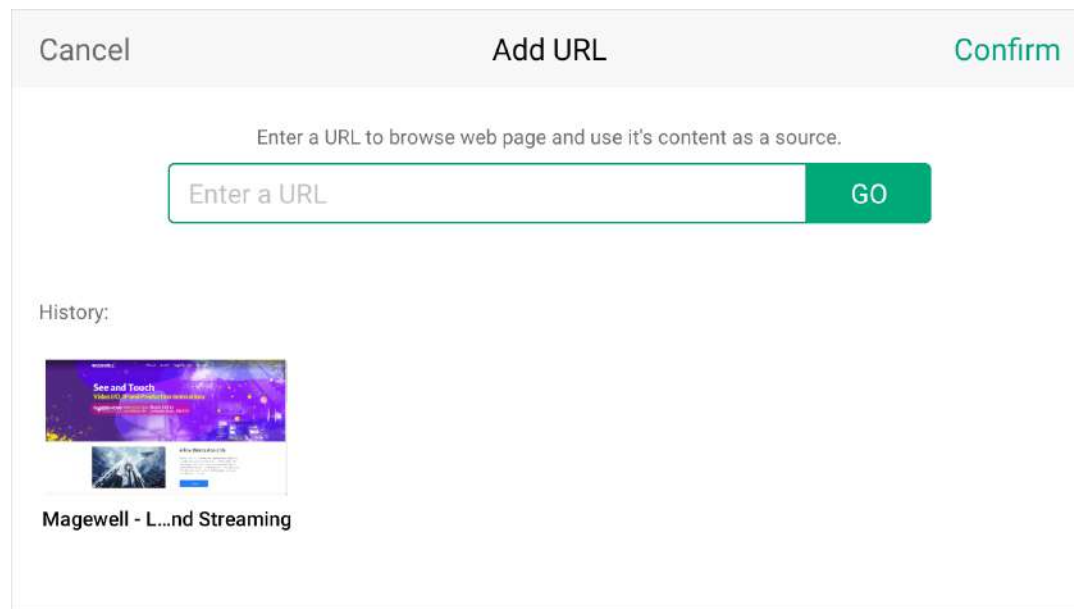

6. Select a detected NDI source in the list to add to the scene. And it is added to the **Preset** list at the same time.
7. Tap **Refresh** to refresh the NDI source list if needed, for example, when the network of Director device changes.

### Add Webpage

1. Tap  in the Scene Editor.
2. Tap **Webpage**.
3. Enter a URL, and tap **Go** or **Confirm**.  
The webpage appears in the canvas, and it is also recorded in the webpage history. You can select one from the history when you try to create a new scene.

- You can only add one webpage for one scene.
- You can add up to 3 webpages as scene sources in a show.
- It is not recommended to add a video URL as it will consume a lot of system resources.

**Create Camera**

Camera Name:

Microphone:

Image Quality:  High  Middle  Low

[Advanced](#)

---

**Create Camera**

Codec:  H.264  H.265

Resolution:  540  720  1080

Frame rate:  30  60

Video bitrate:

Audio bitrate:  64  96  128

Latency:

Buffer duration:

## Add Phone Camera

To use the image from your phone's camera as a source, you have to create Phone Camera on the device at first.

1. Tap in the Scene Editor, and then select **Phone Camera**.
2. Enter the camera name (1 - 32 bytes).
3. Toggle on Microphone, so that the Director device can capture audio from your phone.
4. Select the image quality: High, Middle, Low.
5. (Optional) Tap **Advanced** to set relative properties.
  - **Codec:** H.264, H.265
  - **Resolution:** 540, 720, 1080
  - **Frame rate:** Options change along with the frame rate of the show, which can be 60/59.94/50/30/29.97/25/24/23.98/15 fps. For the details, please refer to [Mapping between the show's frame rate and each output frame rate](#)
  - **Video bitrate:** enter your preferred value.
  - **Audio bitrate:** 64, 96, 128
  - **Latency:** enter a number between 20 to 8000. It is recommended that the latency is configured the same as that of the source.
  - **Buffer duration:** The value ranges from 20ms to 8000ms. You can set a short duration when low latency matters.
6. Tap **Create**.
7. To create more cameras, repeat step 1, and then tap **Create camera** in the **Select Phone Camera** window to add a new camera.

You can create up to three cameras in a show.

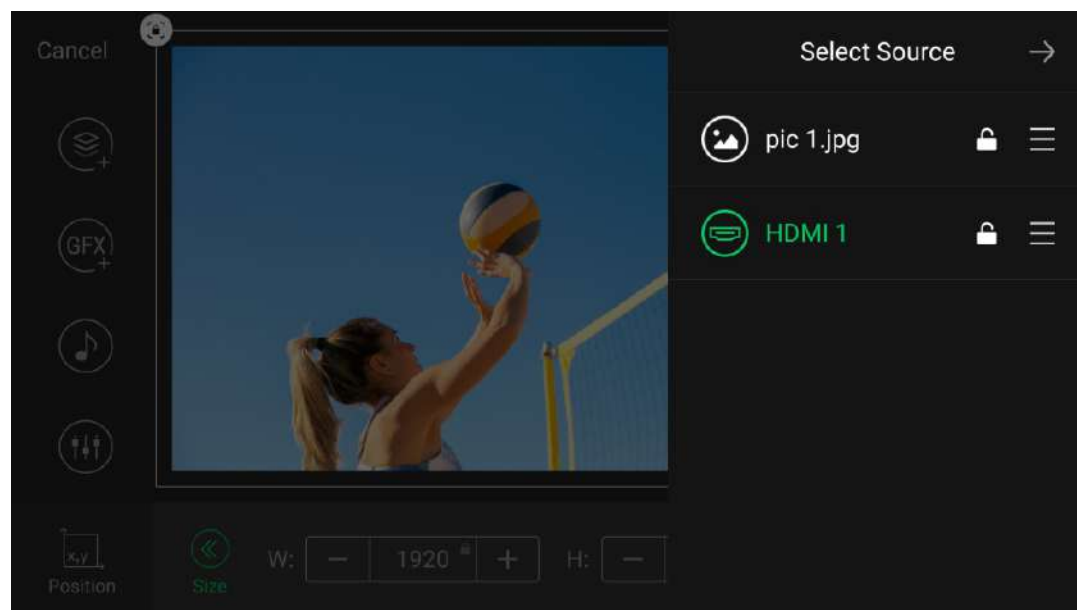
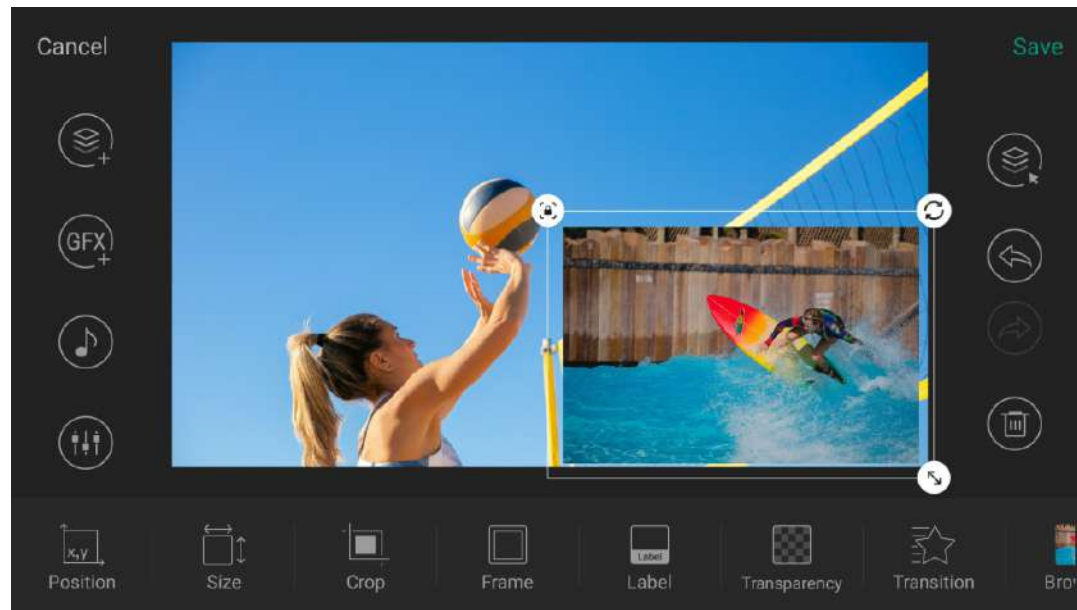

After you have created Phone Cameras on the device, you can use your phone installed with the Director Utility App to connect to the device and control the camera. Please refer to the [Director Utility App User Manual](#).



## Select Source

You can tap a source to select it, and the selected source will have a white frame surrounded.



If multiple sources overlap with each other, and you can select the covered layer by the following way.

1. Tap .
2. Select the source you want to edit in the pop-up window.
3. Tap the lock icon to lock or unlock the position and size of a source layer. When the layer is locked, a red lock button appears on the white frame. You can tap it to unlock the layer.
4. Tap  to go back.

For layers completely covered by a larger layer, you cannot move their position by dragging.

## Change Z-Order

Z-order is an ordering of overlapping sources. You can change the z-order to have a source appearing in front of other sources.

1. Tap .
2. Press and hold , and drag up and down to change a source's display order.
3. Tap  to go back.

## Delete a Source

1. In the Scene Editor, select a source.
2. Tap  to delete the selected source.

## Editing Tools

When a source is selected, editing tools for that source appear in the bottom toolbar.



### Move, Resize & Rotate

All kinds of sources can be moved, resized and rotated.



#### To move a source:

Drag and move the selected source to a new position.



When dragging a source around, guidelines will appear for you to align the source with other sources and the Scene Editor.



To control the position more precisely, see [Position](#).

#### To resize a source:

1. (Optional) Tap  or  on the selected source's frame to unlock/lock the aspect ratio of the selected source.

This operation is not available for a Text source.

2. Drag  (for locked aspect ratio) or  (for unlocked aspect ratio) on the source's frame to scale it up and down.

After you tap  to unlock the aspect ratio and drag  to freely resize a source, you can tap  to restore to the original aspect ratio.

When resizing a source, smart guides will appear for you to scale the source in reference to other sources and the Scene Editor.

To control the size more precisely, see [Size](#).

Cancel Save



X Coordinate  Width

Y Coordinate  Height

Angle  Deg

1	2	3	-
4	5	6	┌
7	8	9	⊗
,	0	.	←

### Undo or redo:

Tap  or  to undo or redo the movement or resizing.

### To rotate a source:

Press and rotate  on the selected source's frame.

To control the rotation more precisely:

1. Tap **Position** or **Size** at the bottom bar.
2. Tap the X or Y number (on the **Position** control), or the W or H number (on the **Size** control).
3. On the page displayed, set **Angle**.
4. Tap **Save**.



### Position

Apart from dragging and moving a source to change position, you can also tap **Position** to set position more precisely.

- **X, Y:** Tap the number to specify the X and Y coordinates of the source's center. Or tap or long-press an arrow button to move the source horizontally/vertically.
- **Auto:** Automatically move a source to a specified position. Nine positions are available, as shown in the image on the left.



## Size

Apart from dragging  on a source's frame to scale it up and down, you can also use the **Size** control to set size more precisely.

- **W, H:** Tap the W or H number to specify the width and height in pixels of the source. Or tap +/- to scale up/down the source.

The value ranges for W and H are as follows:

**When the aspect ratio is locked (indicated by the  icon on the source frame):**

- W: 0 to 1280 or 1920 pixels, depending on the resolution of your show
- H: 0 to 720 or 1080 pixels, depending on the resolution of your show
- When the value of W changes, the value of H changes accordingly, or vice versa.

**When the aspect ratio is unlocked (indicated by the  icon on the source frame):**

- W: 0 to 1280 or 1920 pixels, depending on the resolution of your show
- H: 0 to 1280 or 1920 pixels, depending on the resolution of your show

- **Full Screen:** Tap this button to expand the source to full screen.

- When you lock the aspect ratio, a source is expanded to full screen when either its width or height reaches that of the canvas.
- When you do not lock the aspect ratio, a source is stretched to fill the whole canvas, in which case the source can be distorted.

- **More:** You can tap or long-press one of the buttons to scale up/down the source towards the corresponding direction. Tapping changes the size by one pixel while long-pressing changes the size continuously.

-  : Scales up a source to a specified direction, as indicated by the arrow in the icon.

The buttons are unavailable when your source is already at the largest size.

-  : Scales down a source to a specified direction, as indicated by the arrow in the icon.

The buttons are unavailable when your source is already at the smallest size.

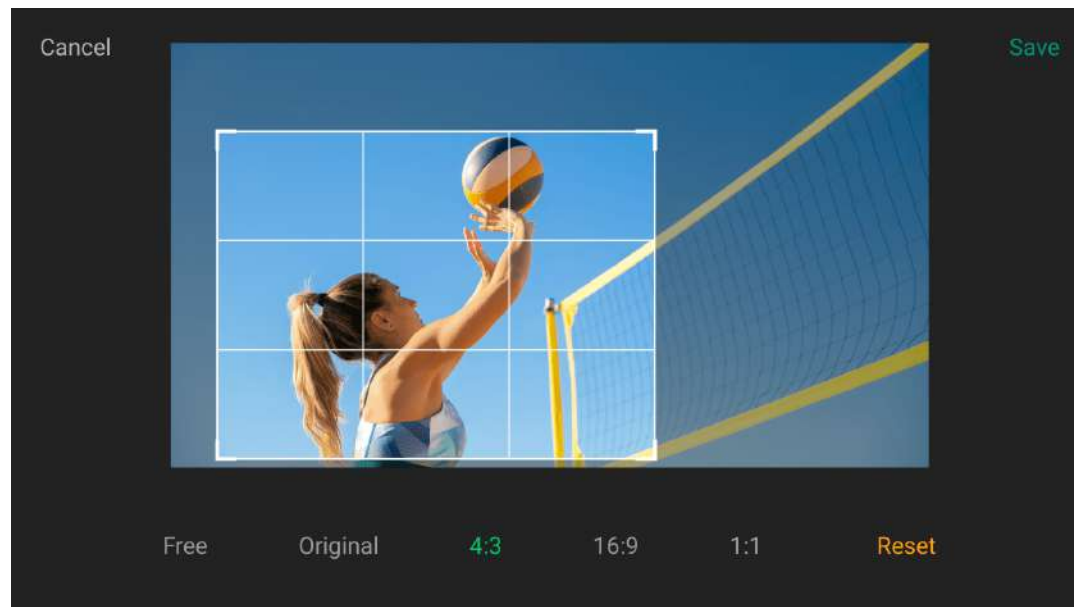

## Crop

Cropping allows only part of the source to be rendered in the scene. All sources except text and color can be cropped.

1. Tap **Crop** in the toolbar.
2. Select a cropping ratio.
3. Drag the corner handles to specify the crop boundaries.

Tap **Reset** to revert to the original size and aspect ratio of the source.

4. Tap **Save** to save changes and go back to Scene Editor.

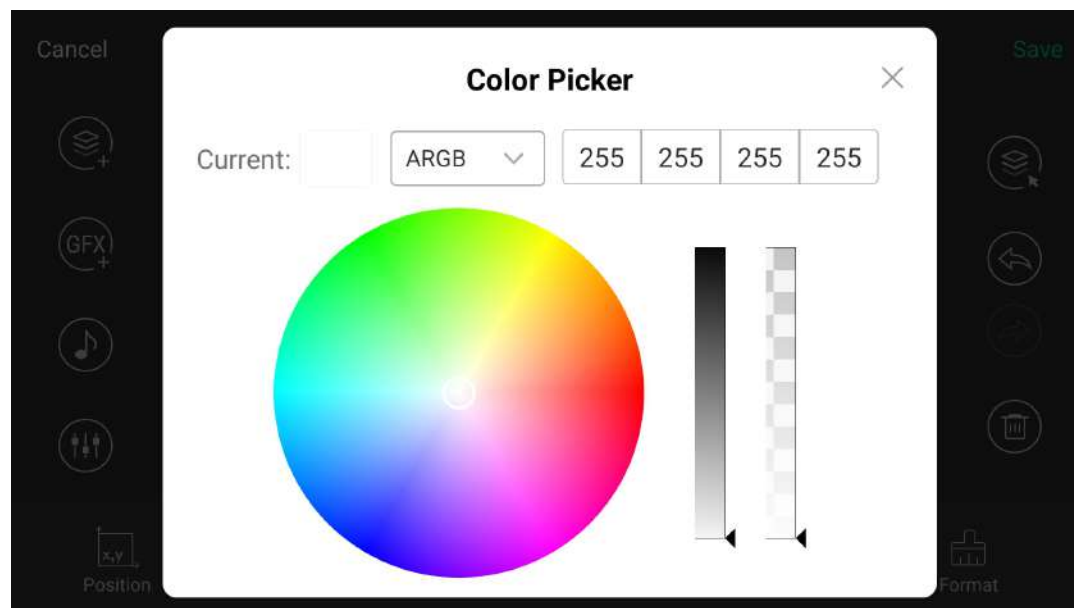

## Color

This function works with the color source. It is also a sub-function of other tools, such as text and background.

1. Tap **Color**.
2. Swipe the color bar to the left or right to choose a color.
3. If the color provided by the system cannot meet the needs, swipe the color bar to the far right, tap  to open the color selector.
  - Tap to select a color in the color wheel, drag the sliders on the right vertical bars to adjust the intensity and brightness.
  - Or select a color model which can be HEX, ARGB or HSL, and the code or value.

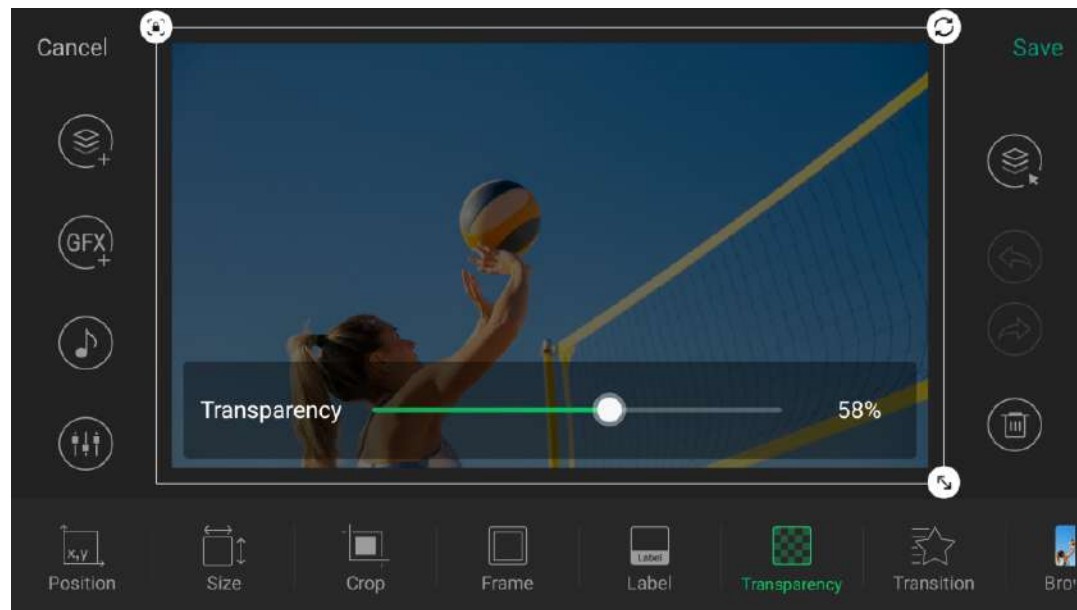

## Transparency

This feature works with the color, picture and video clip source. It is also a sub-function of other tools, such as text and background.

Tap **Transparency** and move the slider to adjust the transparency. It ranges from 0 (solid) to 100 (completely invisible).



## Frame

You can decorate a source with a **Frame**.

A frame is defined by the following properties:

- **Weight:** Sets the frame's border weight. It ranges from 0 to 50 pixels, with 0 indicating no frame.
- **Color:** Sets the frame's color, with white as the default.
- **Corners:** Sets the frame's corner radius, which can range from 0 to 100. When the **Round** value is zero, all corners are squared; otherwise, all corners are rounded accordingly.
- **Position:** Sets the frame's position to be inside or outside the source. It is inside the source by default, which means that the frame overlaps the source.
- **Reset:** Erases the frame.

💡 When you tap **Frame**, a basic white frame is instantly added on the source.



## Label

When you tap **Label**, the source is instantly labeled by its type name or file name. You can change the text and its properties to make a special mark. This tool is available for all sources except text and color.

1. Tap the text area and then change the text.

A maximum of 1024 characters are supported in total. The more text that is input, the smaller the font will appear. The font size also changes automatically with the label size.

2. Set properties of label.
  - **Theme:** Sets the label's theme color, with white as the default. If the theme provided by the system cannot meet your needs, swipe the theme bar to the far right, tap **Custom**, and then tap **Text** and **Background** to set the color of text and background.
  - **Dock:** Sets the label's direction (bottom, top, left or right).
  - **Position:** Sets the label's position (inside or outside the source). The default position is inside the source, which means that the label and source are overlapped.
  - **Size:** Sets the label's height, ranging from 0 to 45, which indicates the proportion of the label height to the source height. The default value is 30.
  - **Font:** Sets the label text's font.
  - **Alignment:** Sets the alignment (left, center or right) of the label text.
  - **Reset:** Removes the label.



## Transition

Tap **Transition** to add dynamic effects to your sources.

This tool is available for all sources.

### Add entrance transition:

Tap **In** and select an entrance effect from the **All** tab or any other category tab.



**None:** No entrance transition (default).



**Fade:** Fade in.





**Fly:** Fly in from 4 directions, as indicated by the arrows.

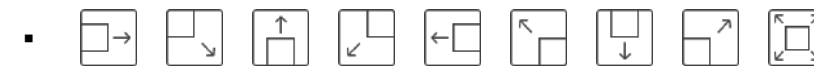

**Expand:** Expand in from 6 directions, as indicated by the arrows.



**Zoom:** Zoom in from 9 directions, as indicated by the arrows.

After you select an entrance transition for the first time, Director device automatically sets the corresponding exit transition for you. For example, when you set the entrance transition as , the exit transition is set to . You can change the exit transition effect.



### Add exit transition:

Tap **Out** and select an exit effect from the **All** tab or any other category tab.



**None:** No exit transition (default)



**Fade:** Fade out.



**Fly:** Fly out to 4 directions, as indicated by the arrows.



**Collapse:** Collapse out to 6 directions, as indicated by the arrows.

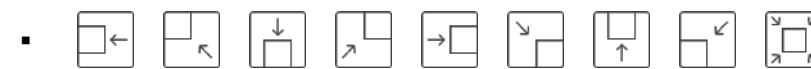

**Zoom:** Zoom out to 9 directions, as indicated by the arrows.

After you manually change the exit transition, the entrance transition will not change accordingly. The exit transition will not change along with the entrance transition thereafter.

### Change transition speed:

Tap **Duration** and move the slider. It applies to both the entrance transition and exit transition. A longer duration means a slower transition.

### Test transition effect:

Tap **Test** to preview the transition effect of the source layer.

### Erase transition:

Tap **Reset** to erase transition effects.

You can check the transition effect on second screen, recording video or streaming target.



## Text

This tool applies to the Text source.

Tap **Text** at the toolbar to define the following properties:

- **Color:** Sets text color.
- **Font:** Sets text font.
- **Case:** Sets text to all uppercase or lowercase.
- **Alignment:** Sets text alignment (left, center or right).
- **Transparency:** Sets text transparency.
- **Shadow:** Applies a shadow to the text. 0 indicates no shadow.
- **Crawl:** Makes the text crawling on the screen by specifying the crawling speed and direction. Speed 0 means no crawling.
- **Reset:** Reverts to the original properties.



## Background

This function applies to the Text source.

Tap **Background** to define the following properties:



- **Color:** Specifies a solid color as the text background.
- **Gradient:** Specifies a gradient color as the text background.
- **Picture:** Specifies a picture as the text background. The picture format can be JPG or PNG.
- **Transparency:** Sets the transparency of text background.
- **Reset:** Clears the background.

Color, Gradient and Picture are mutually exclusive. Applying one will overwrite the other.



## Flip



This tool applies to HDMI and webcam sources.

- Tap  **Horizontal** to flip the source from left to right.
- Tap  **Vertical** to flip the source from top to bottom.



## Chromakey

**Chromakey** can remove the background of HDMI, WEBCAM, SRT/RTMP/RTSP stream, NDI® stream, Phone Camera and Video sources.

1. Tap **Chromakey**, and the system implements keying with an auto algorithm.
2. Tap **Key color**, and select a color to key.
3. If you want to key other color, tap  to open the color setting page, tap on the preview image to select a color, or enter RGB value at the bottom, and then tap **Save**.
4. With  selected, you can tap **Advanced** to adjust Similarity, Smoothness and Spill.
5. To cancel keying, tap **Reset**.

To get a good effect, you can build the background as follows.

- Use a bright green or blue screen. The contrast in colors makes it easier to distinguish you in the foreground from the bright background. Professional physical green screens are recommended.
- Make sure the background is flat without any wrinkles or seams, avoiding shadows and uneven lighting.
- Use higher quality cameras.
- Ensure that your background color does not match your shirt, hair, or eye color.
- Adjust your distance from background to avoid color spill.
- Use uniform lighting to make the background receive light evenly, and avoid your shadow falling on the background. It is recommended to use a 3-point lighting setup.

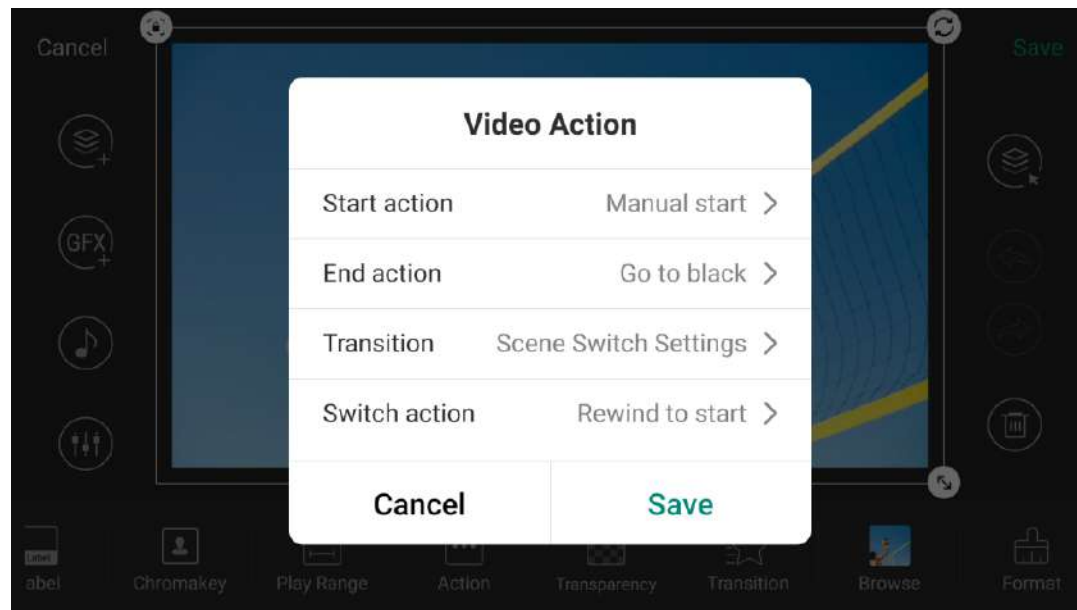

## Action

This function applies to the Video Clip source.

Action defines how a video source is played.

- **Start action:** Defines how video playback is started.
  - **Auto start:** Starts to play the video automatically.
  - **Manual start:** Starts to play or pause the video by tapping the Play/Pause button on the scene thumbnail.
- **End action:** Defines the action to take when the video playback is over.
  - **Go to black:** Video area turns black.
  - **Repeat video:** Plays the video repeatedly.
  - **Show last frame:** Stops the video and displays the last frame.
  - **Show first frame:** Stops the video and displays the first frame.
  - **Hide video:** Hides the video, which makes the video disappear from the screen.
  - **Switch to scene xx:** Switches to scene xx automatically. When the video is playing back, the scene to switch to will be highlighted with a flashing yellow frame, a LIVE SOON mark and a countdown clock during the last 10s of the current video.
- **Transition:** Defines the transition effect of the video when it is set to switch to scene xx.
  - **Always Cut:** an instant cut always applies when the video is switched out automatically.

- **Always Fade:** a fade effect always applies when the video is switched out automatically.
- **Scene Switch Settings:** follow the scene switch settings when the video is switched out automatically.
- **Switch action:** Defines how the video is continued if the scene is switched out to another scene and then back before the video playback ends.
  - **Rewind to start:** Replays the video from the beginning.
  - **Pause video:** Pauses the video when the scene is switched out, and resumes when the scene is switched back.

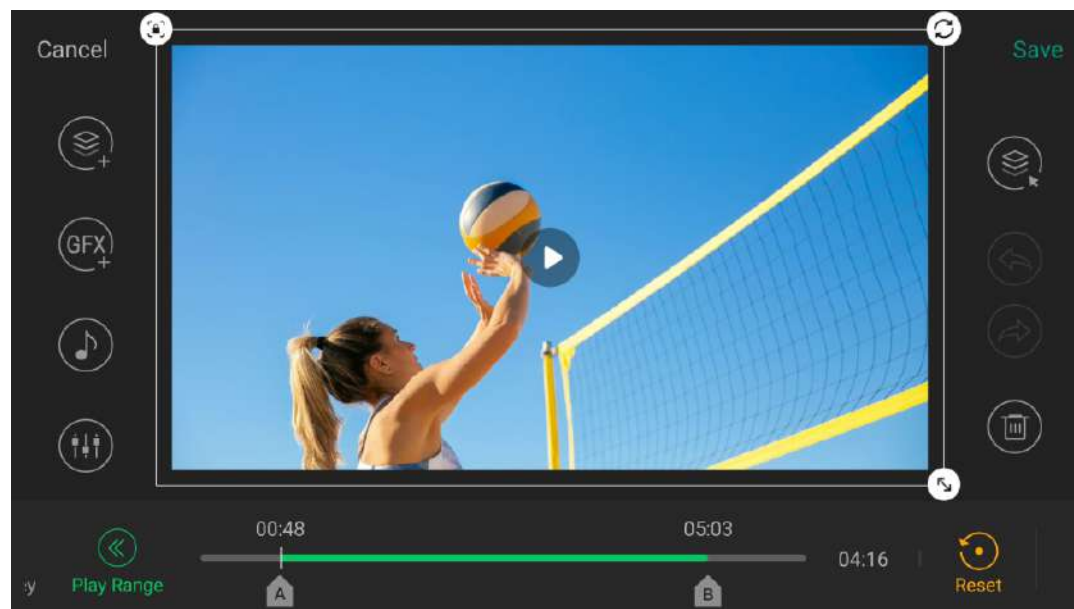

## Play Range

This function applies to the Video Clip source.

An entire video will be played by default, but you can specify a start and end point if you wish to only play part of a video.

As shown in the figure on the left, you can drag and move **A** and **B** tags on the video's progress bar to define start and end points.

## Browse

This function applies to the Video Clip and Picture sources.

Tap **Browse** to open the storage, where you can select an image or a video clip to replace the current one.

And you can select 2 to 100 pictures or videos to enable a picture or video slide show.

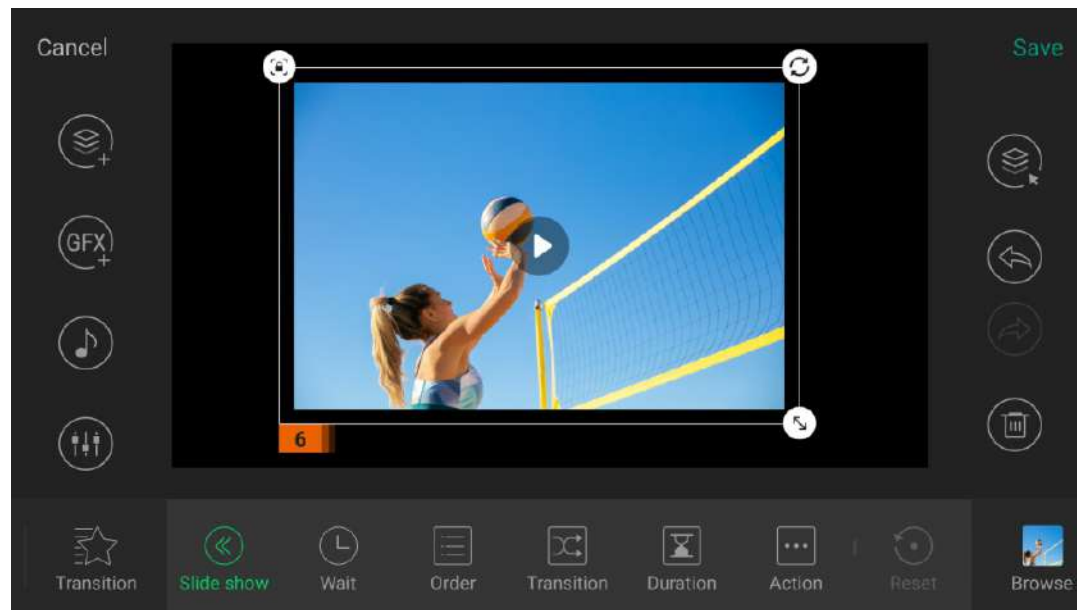

## Slide Show

To enable a slide show, you can select 2 to 100 pictures or videos when adding or browsing picture or video sources.

For the picture slide show, you can set the following properties.

- **Wait:** Set the time for each picture stayed on the screen.
- **Order:** Set the playback order of pictures, in shuffle or sequence.
- **Transition:** Set the transition effect for switching pictures.
- **Duration:** Set the transition duration.
- **Action:** Define how a slide is played.
  - **Start action:** Defines how slide playback is started.
    - **Auto start:** Starts to play the slide automatically.
    - **Manual start:** Starts to play or pause the slide manually.
  - **End action:** Defines the action to take when the slide playback is over.
    - **Display last image:** Stops the slide and displays the last image.
    - **Display first image:** Displays the first image.
    - **Go to black:** Slide area turns black.
    - **Repeat slide:** Plays the slide repeatedly.
    - **Hide:** Hides the video, which makes the video disappear from the screen.
    - **Switch to scene xx:** Switches to scene xx automatically.
- **Switch action:** Defines how the slide is continued if the scene is switched out to another scene and then back before the slide playback ends.
  - **Rewind to start:** Replays the slide from the beginning.

- **Pause video:** Pauses the slide when the scene is switched out, and resumes when the scene is switched back.

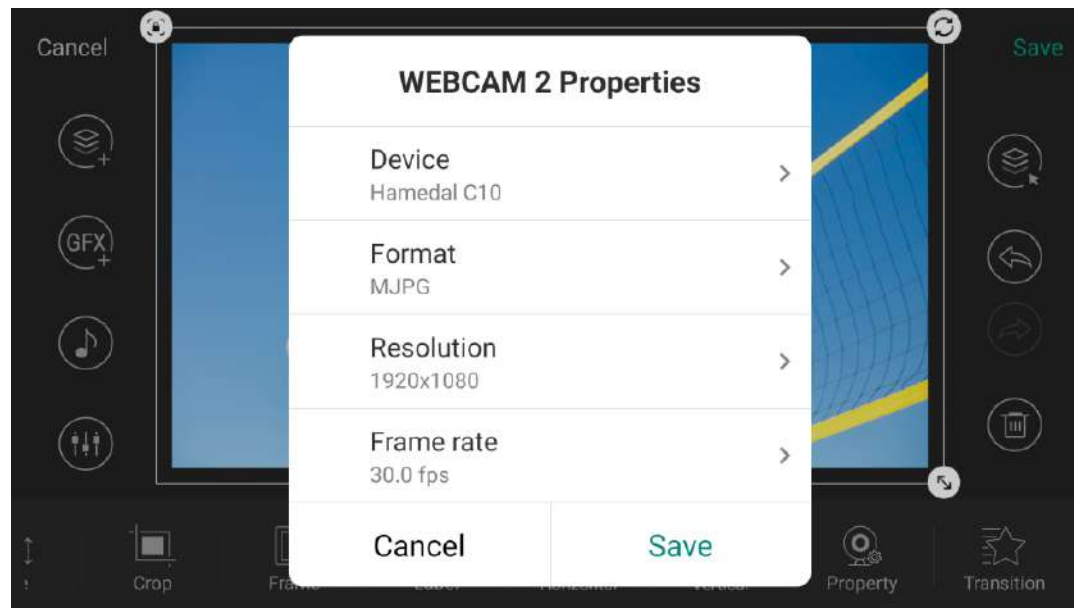

## Property

This tool applies to WEBCAM, Phone Camera and NDI sources.

### Change WEBCAM's Properties

1. Ensure that a WEBCAM is connected to the device.
2. Select the WEBCAM source.
3. Tap  to open the WEBCAM Properties window.
4. View and select properties of the WEBCAM.
  - **Device:** the information of current WEBCAM. Tap **Device**, and it lists all the connected WEBCAM devices. You can select one to switch. If one device is bound with the other WEBCAM, you need to confirm the selection after you tap Save.
  - **Format:** the current format. Tap **Format**, and it lists all the available format options. You can select one to switch.  
Supported formats: YUYV, MJPG, NV12, UYUV
  - **Resolution:** the current resolution. Tap **Resolution**, and it lists all the available resolution options. You can select one to switch.  
Supported resolution: up to 1920x1080
  - **Frame rate:** the current frame rate. Tap **Frame rate**, and it lists all the available frame rate options and uses the frame rate matching the show by default. You can select one to switch.

Supported frame rate: up to 60fps

The changeable properties and parameters of different WEBCAM devices may differ.

5. Tap **Save** after you change properties.

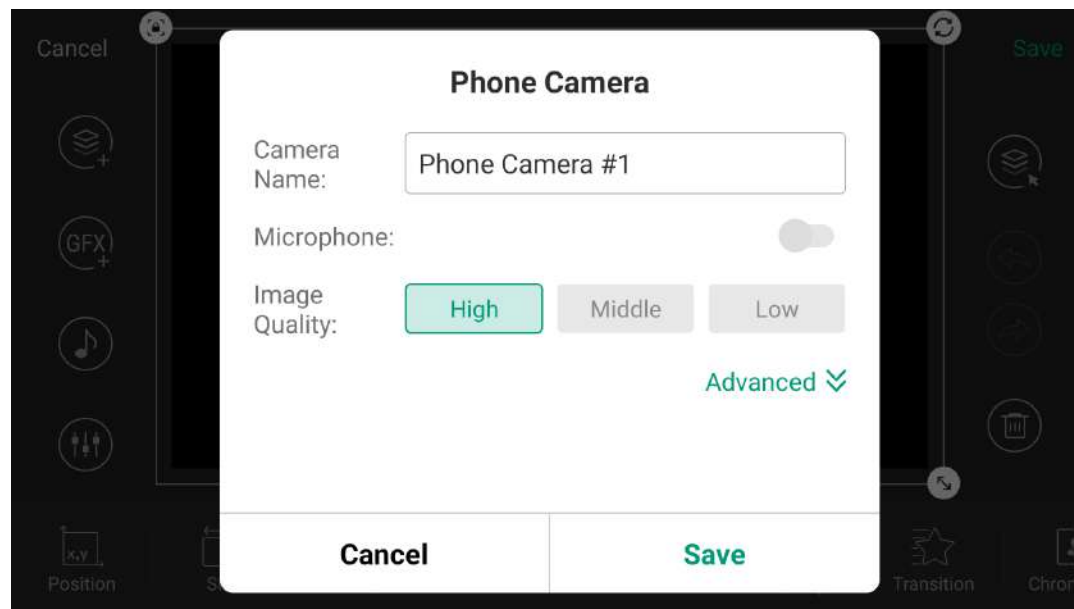

### Change Phone Camera's Properties

1. Select a Phone Camera source.
2. Tap  to open the Phone Camera window.
3. Change properties as needed. For details, please refer to [Create Phone Camera](#).
4. Tap **Save** after you change properties.

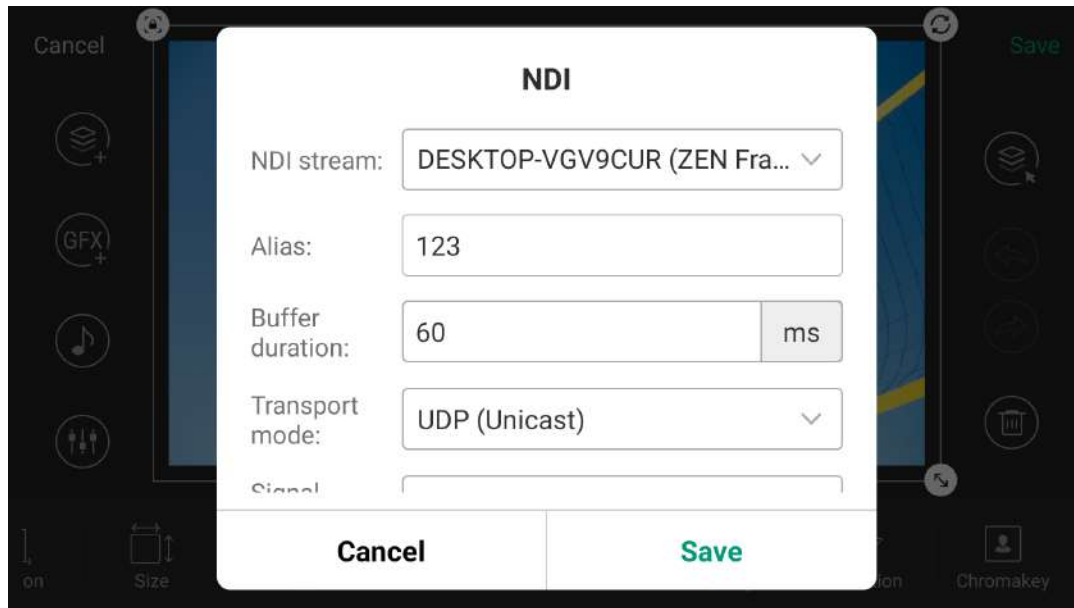

## Change NDI's Properties

1. Select a NDI source.
2. Tap  to open the NDI window.
3. Change NDI source or set properties as needed.
4. Tap **Save** after you change properties.

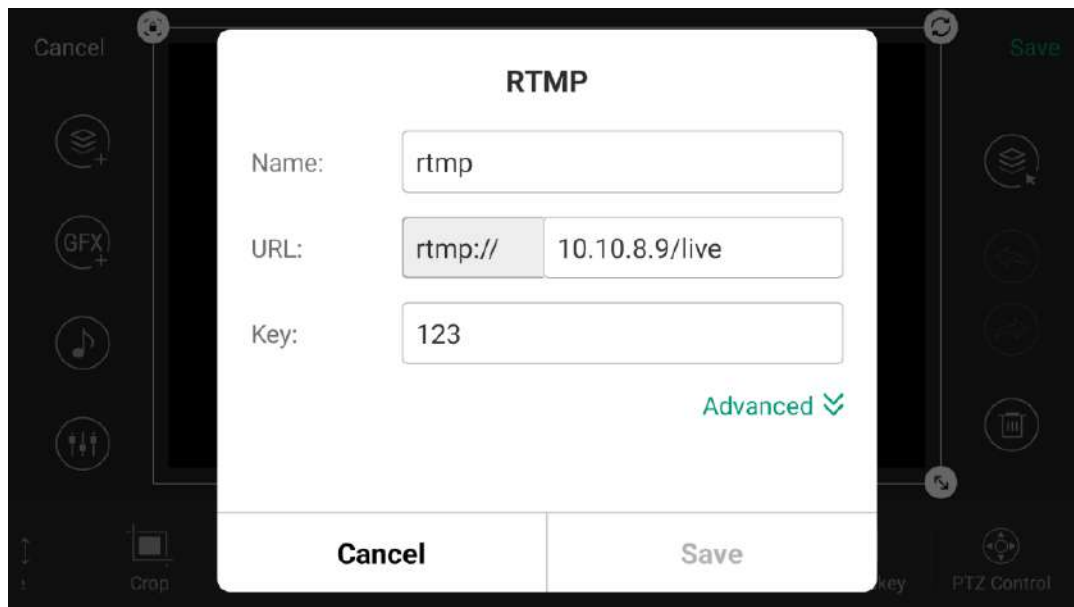

## URL

This tool applies to [RTMP](#), [SRT](#), [RTSP](#) and webpage sources.

### Stream

1. Tap **URL** to open the stream's property window.
2. Change properties as needed.
3. Tap **Save**.

### Webpage

1. Tap **URL** to open the **Edit Webpage** window.
2. Enter a new URL to change the webpage.
3. To delete a webpage, long-press a thumbnail in the History, tap , and confirm to delete in the popup.

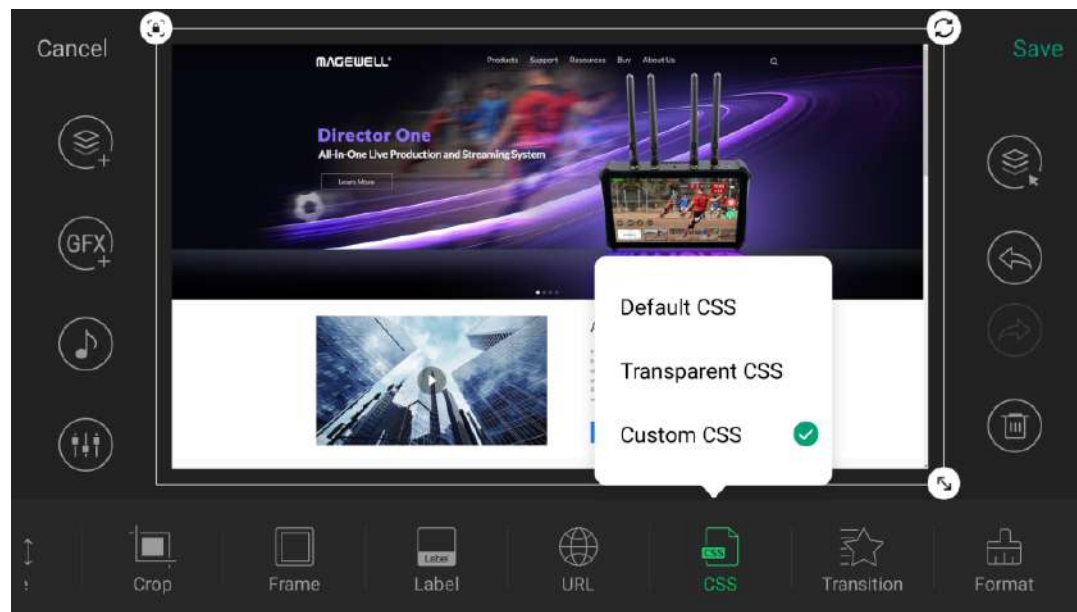

## CSS

This tool is used to set the background of webpage.

- Default CSS: Use the default background of the webpage.
- Transparent CSS: Change the background to transparent.
- Custom CSS: Enter your own CSS, or tap **Import** to import a CSS file from the storage, and then tap **Save**.



## Color Process

For HDMI source, you can use Color Process to adjust its color settings, including Format, Quantization, Brightness, Contrast, Saturation and Hue.

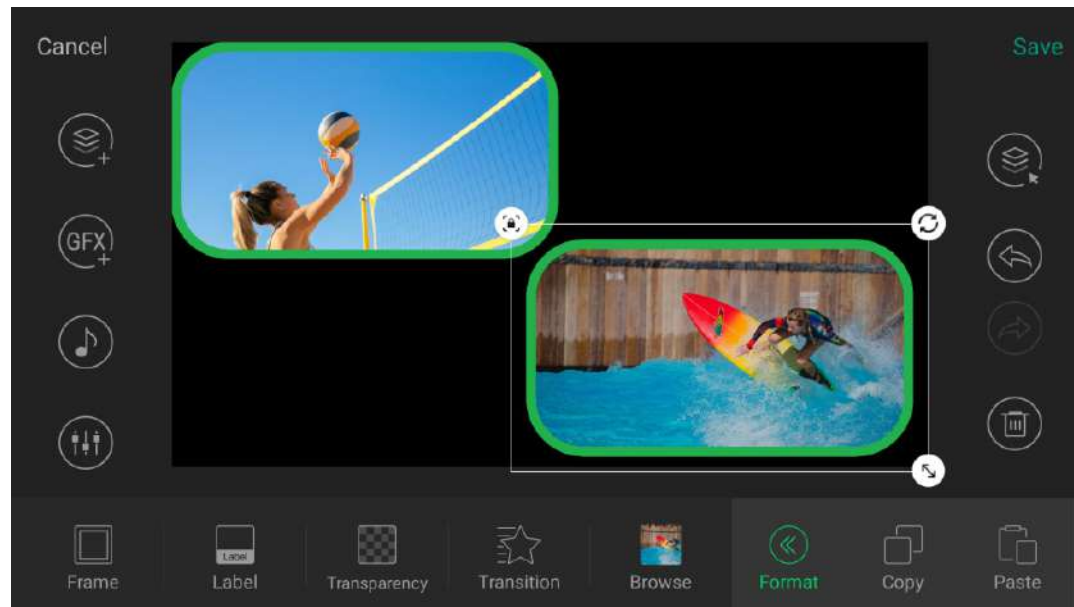
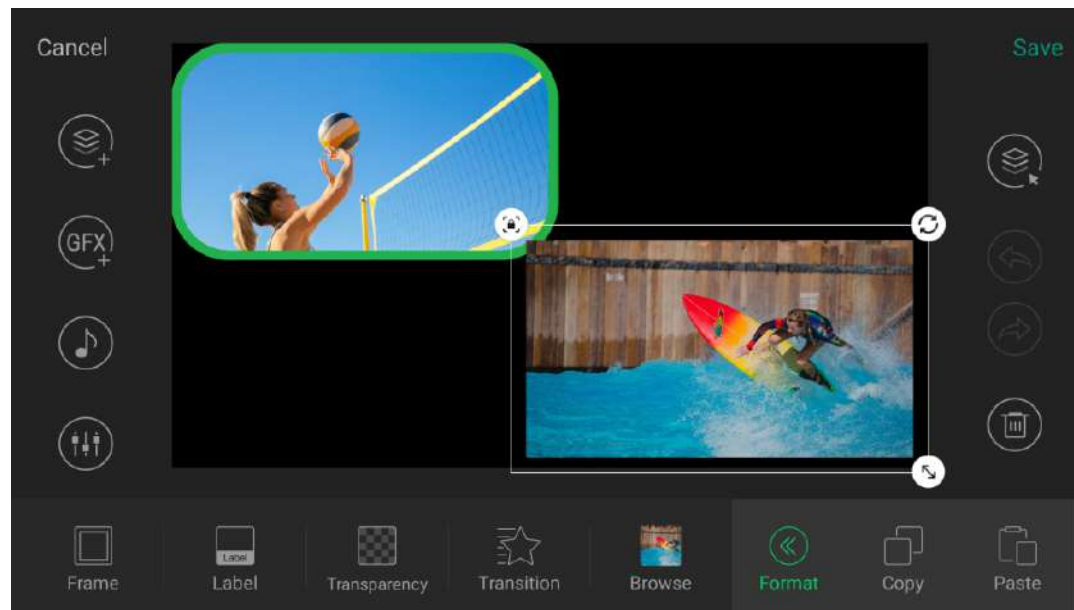

## Format

This function can copy the format of one source and past to another source. It is available for all sources.

However, for text source, it takes effect independently, that is, the format of a text source can only be pasted to another text source.

1. Select a source, tap **Format**, and then tap **Copy**. The format of current source is copied.
2. Select another source, tap **Format**, and then tap **Paste**. The copies format is pasted to the current source.

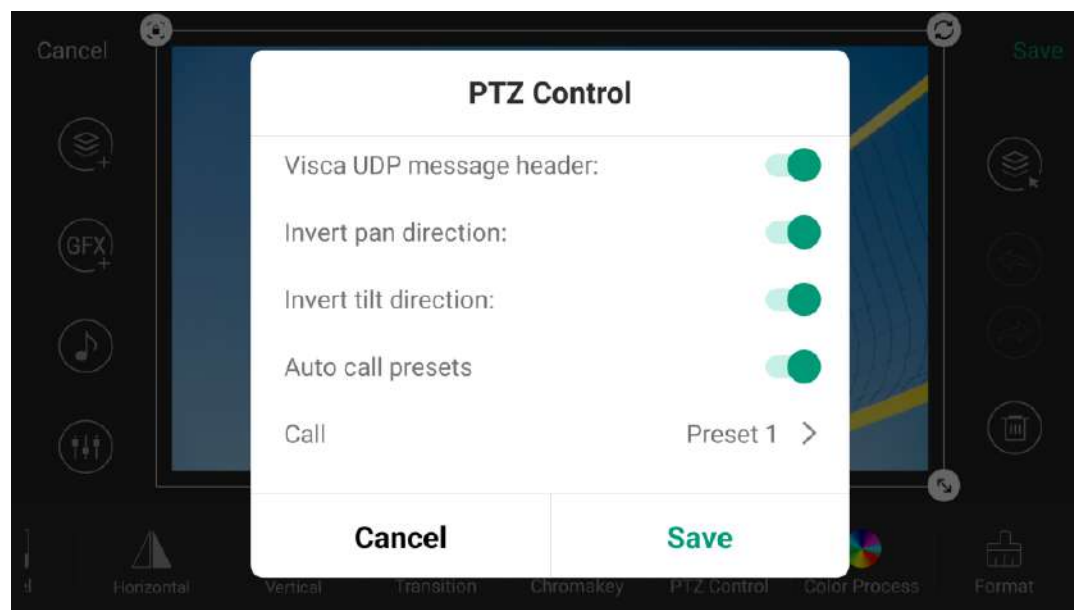
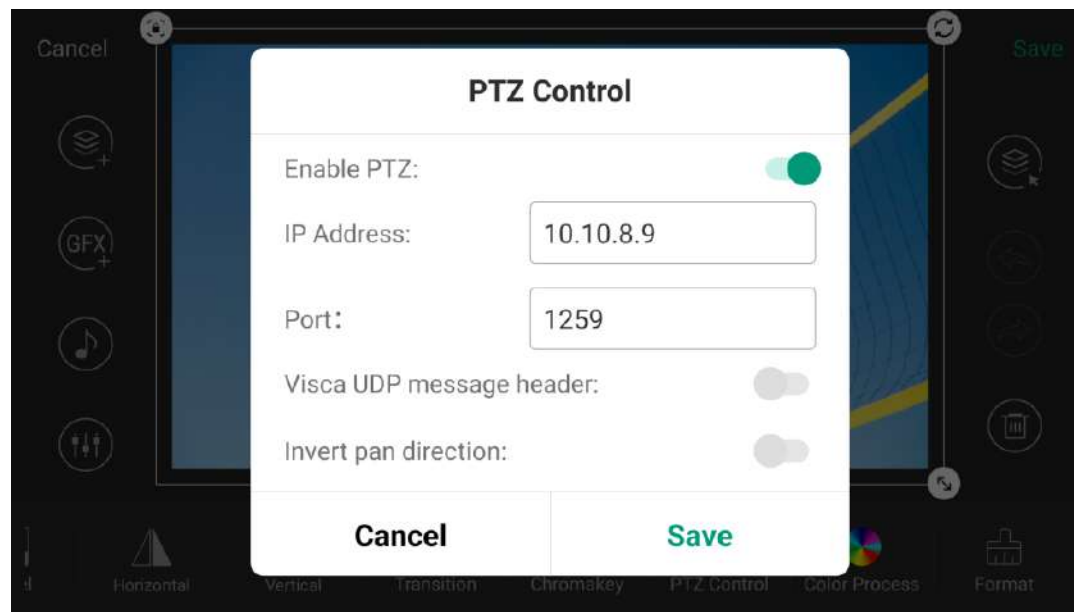

## PTZ Control

When a source is connected with a PTZ camera supporting Visca UDP, you can enable this function to control the PTZ camera through the network. The PTZ camera and Director device must be able to ping each other. Supported sources include HDMI, WEBCAM, [SRT](#), [RTMP](#) and [RTSP](#).





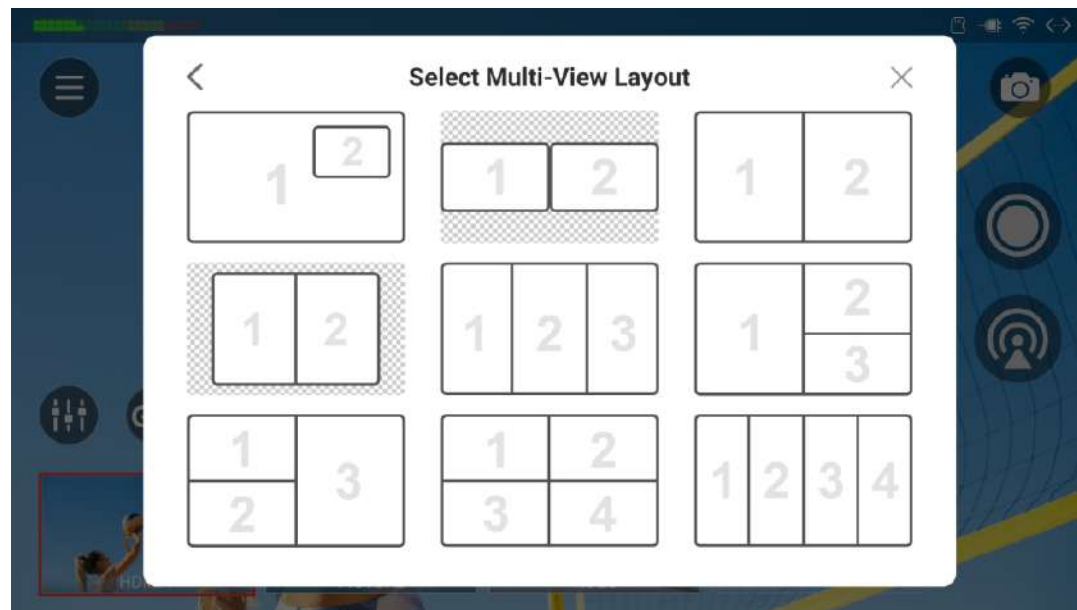

When the NDI source is connected with a PTZ camera, you can also setting relative properties.

- **Enable PTZ:** Toggle on to enable PTZ control. (Not available for NDI)
- **IP Address:** The IP address of your camera. (Not available for NDI)
- **Port:** Your camera's Visca protocol network port (Check the user manual of the camera or contact the manufacturer to get it). (Not available for NDI)
- **Visca UDP message header:** Toggle on this option if your camera's (e.g. SONY camera) communication protocol contains the Visca UDP header. Or else, the Director device may not be able to control the PTZ camera. (Not available for NDI)
- **Invert pan direction:** Toggle on to reverse the pan-direction movement. You can enable this option to make control more intuitive when the camera is not installed in the normal position.
- **Invert tilt direction:** Toggle on to reverse the tilt-direction movement. You can enable this option to make control more intuitive when the camera is not installed in the normal position.
- **Auto call presets:** Toggle on and select a preset. When the scene is switched to program, the camera moves to the selected preset position automatically. For how to set presets, please refer to [PTZ Control](#).



## Add Multi-View Scene

The prebuilt Multi-View layouts can help you create multi-view scenes more easily.

1. Tap  in the scene list on the main screen.
2. Select **Multi-View** in the **Create New Scene** window.
3. Select one layout template.
4. Tap each box and select source thumbnails, and you can tap  to add a source if needed.
5. The source fills the box and remains centered by default. You can move the source within a box to change the displayed portion, and double-click to return the source to its original centered display.
6. For some layout templates, you can drag the split lines to change their position.
7. Tap **Continue** to enter the scene editor.
8. Tap  to reselect sources.
9. Edit basic properties with tools, referring [Multi-View Layouts and Tools](#). You can also move the source within a box to change the displayed portion, and double-click to return the source to its original centered display.
10. Tap **Advanced** to edit other properties like normal scenes, and tap **Multi-View** to go back.
11. Tap  at the left to change layout if needed.
12. Tap  to add private BGM. For details, see [Background Music](#).
13. Tap  to set audio. For details, see [Volume Control](#).

14. Tap **Save** at the upper right corner.

## Multi-View Layouts and Tools

### Layout 1



- **Position:** change the position of the small box.
- **Size:** drag the slider to change the size of the small box.
- **Frame:** create a frame for the small box by setting thickness and color. If the thickness is set to zero, the frame is invisible.
- **Margin:** drag the slider to change the margin of the small box, which does not work when the small box is in the center.

### Layout 2



- **Background:** use a color, gradient or picture as the background.
- **Size:** drag the slider to change the size of the two boxes.
- **Frame:** create frames for the two boxes by setting thickness and color. If the thickness is set to zero, the frame is invisible.

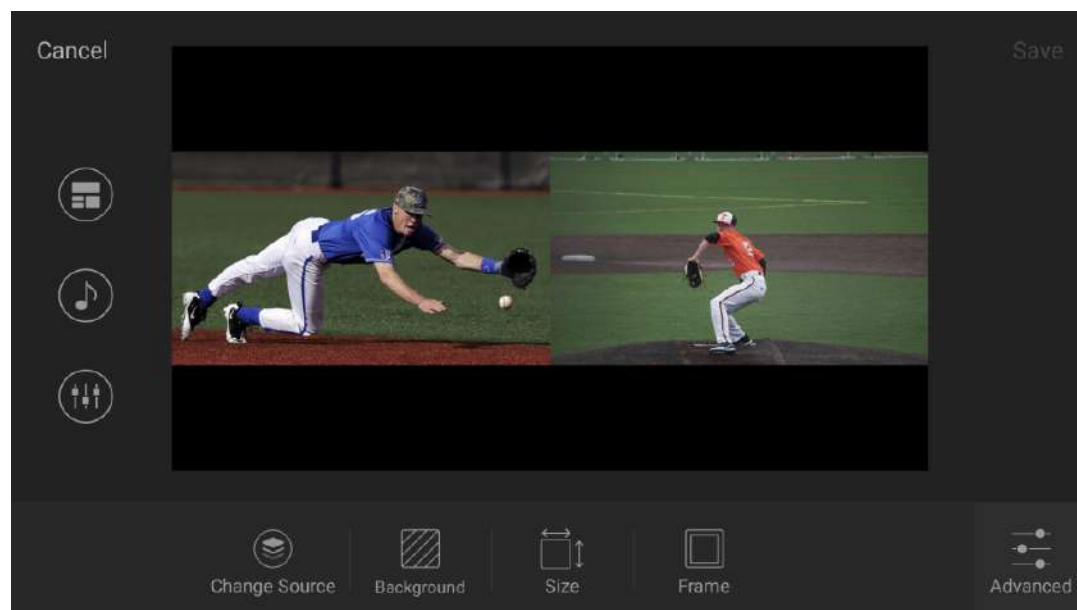
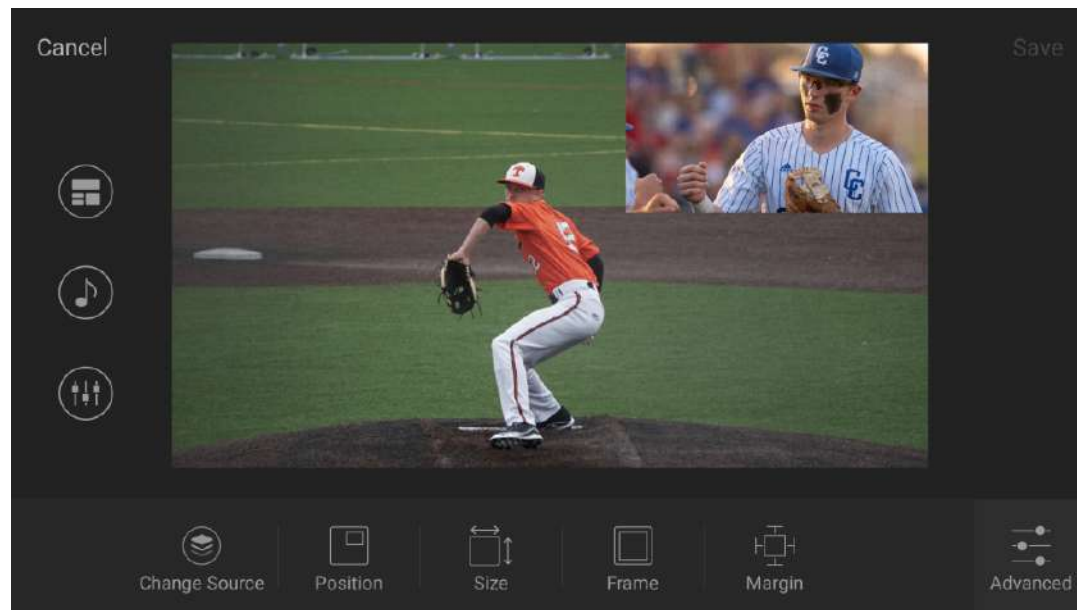

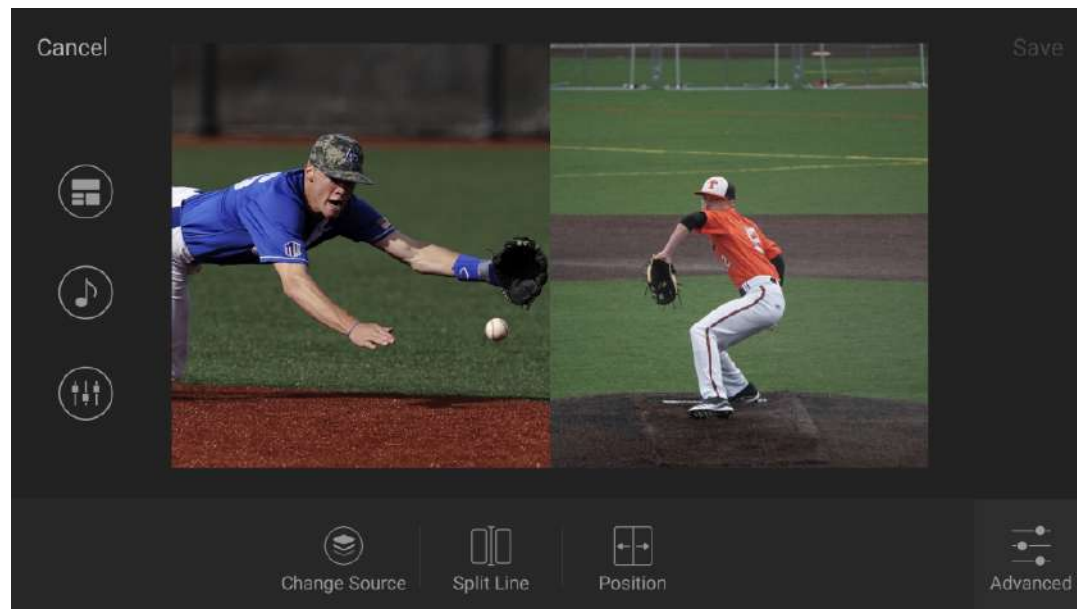

### Layout 3



- **Split Line:** show a split line between the two boxes by setting thickness and color. If the thickness is set to zero, the split line is invisible.
- **Position:** drag the slider to change the position of the split line.

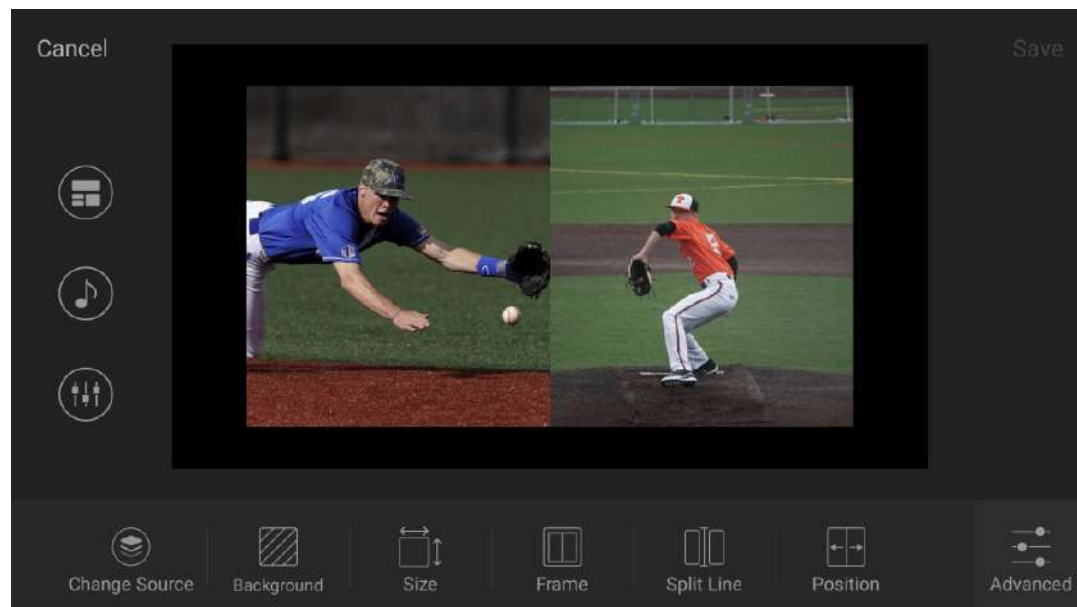

### Layout 4



The two boxes are combined as one layer.

- **Background:** use a color, gradient or picture as the background.
- **Size:** drag the slider to change the size of the whole layer.
- **Frame:** create a frame for the whole layer by setting thickness and color. If the thickness is set to zero, the frame is invisible.
- **Split Line:** show a split line between the two boxes by setting thickness and color. If the thickness is set to zero, the split line is invisible.
- **Position:** drag the slider to change the position of the split line.

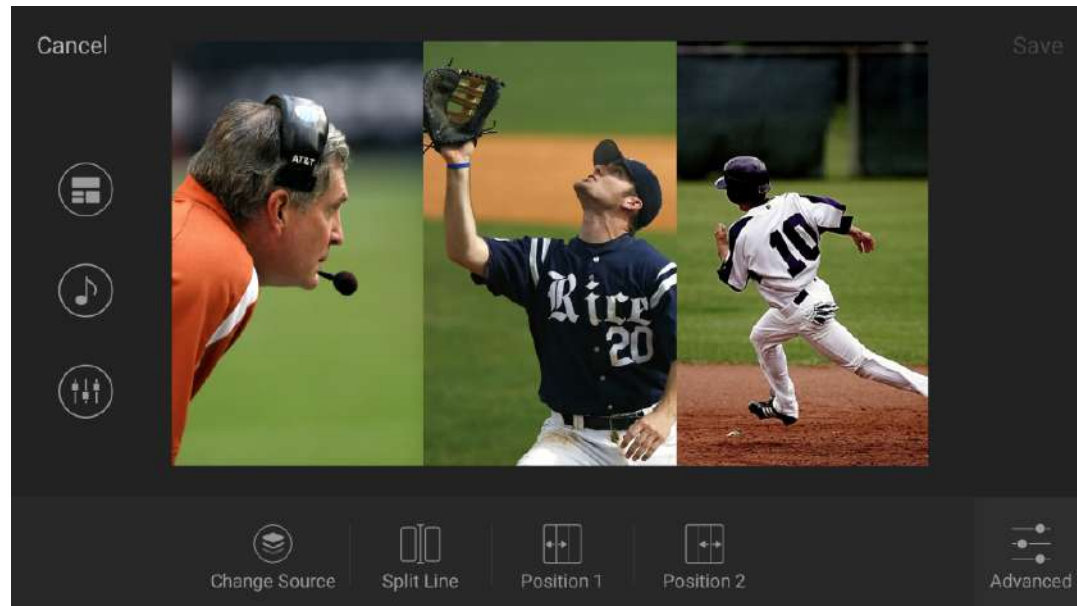

### Layout 5



- **Split Line:** show split lines among the three boxes by setting thickness and color. If the thickness is set to zero, the split line is invisible.
- **Position 1/2:** drag the slider to change the position of the split lines.

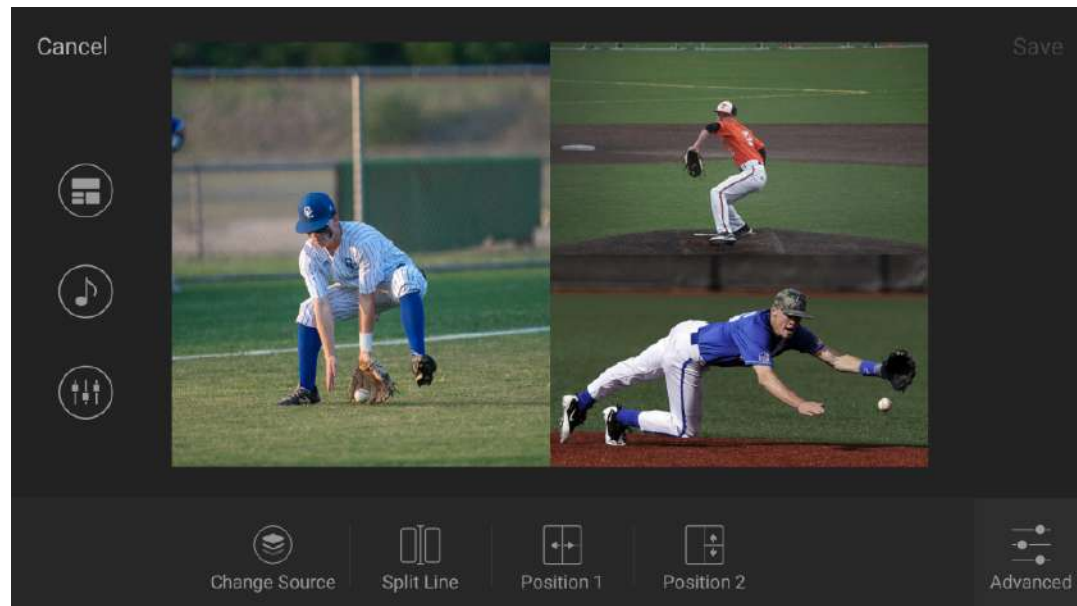

### Layout 6

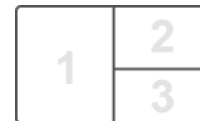

- **Split Line:** show split lines among the three boxes by setting thickness and color. If the thickness is set to zero, the split line is invisible.
- **Position 1/2:** drag the slider to change the position of the split lines.

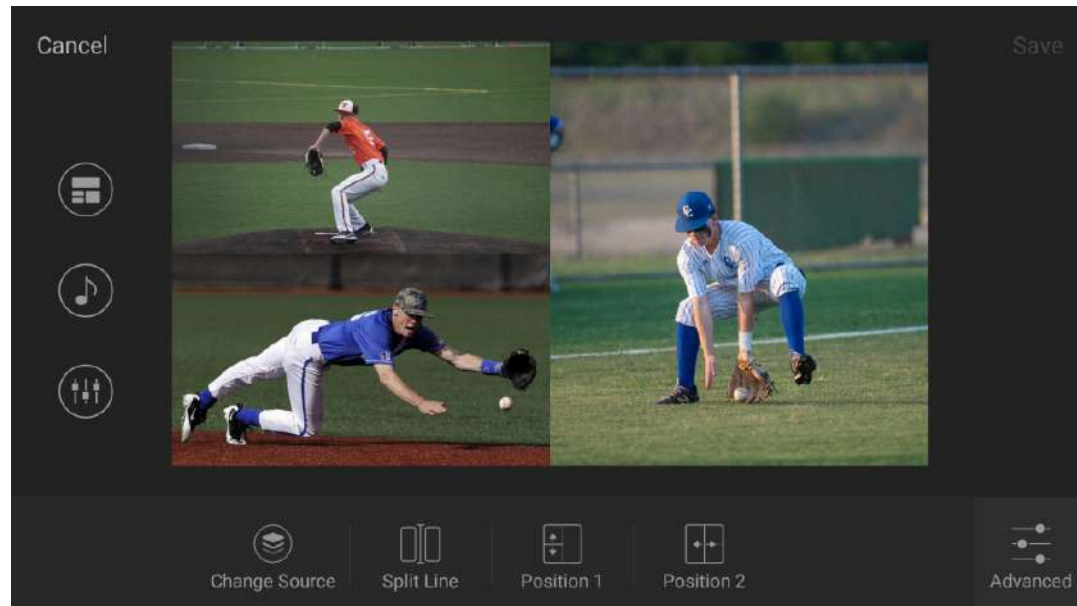

### Layout 7

1	3
2	

- **Split Line:** show split lines among the three boxes by setting thickness and color. If the thickness is set to zero, the split line is invisible.
- **Position 1/2:** drag the slider to change the position of the split lines.

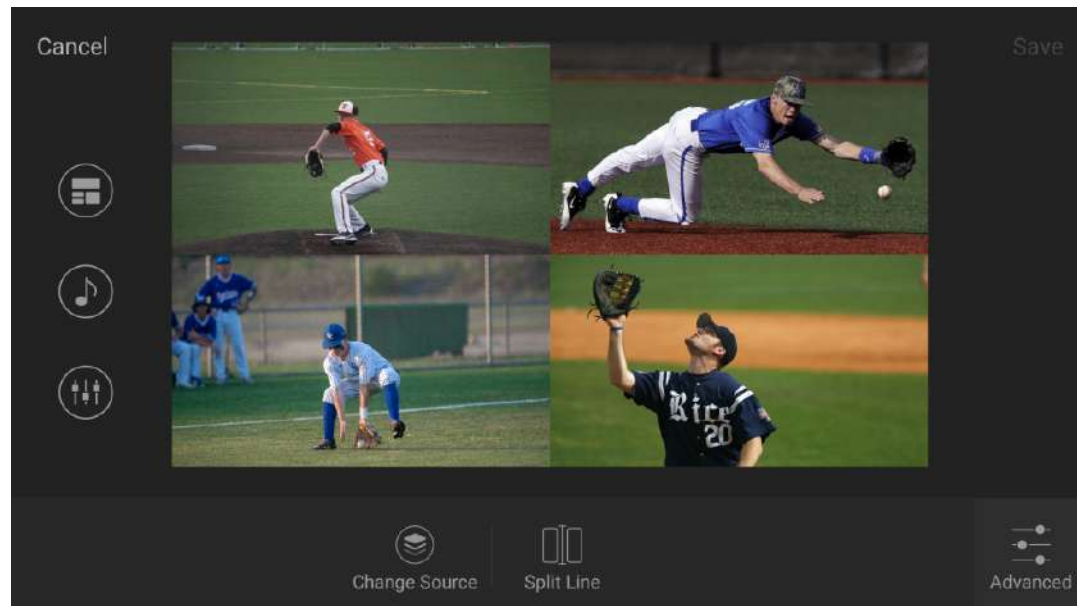

### Layout 8

1	2
3	4

- **Split Line:** show split lines among the four boxes by setting thickness and color. If the thickness is set to zero, the split line is invisible.

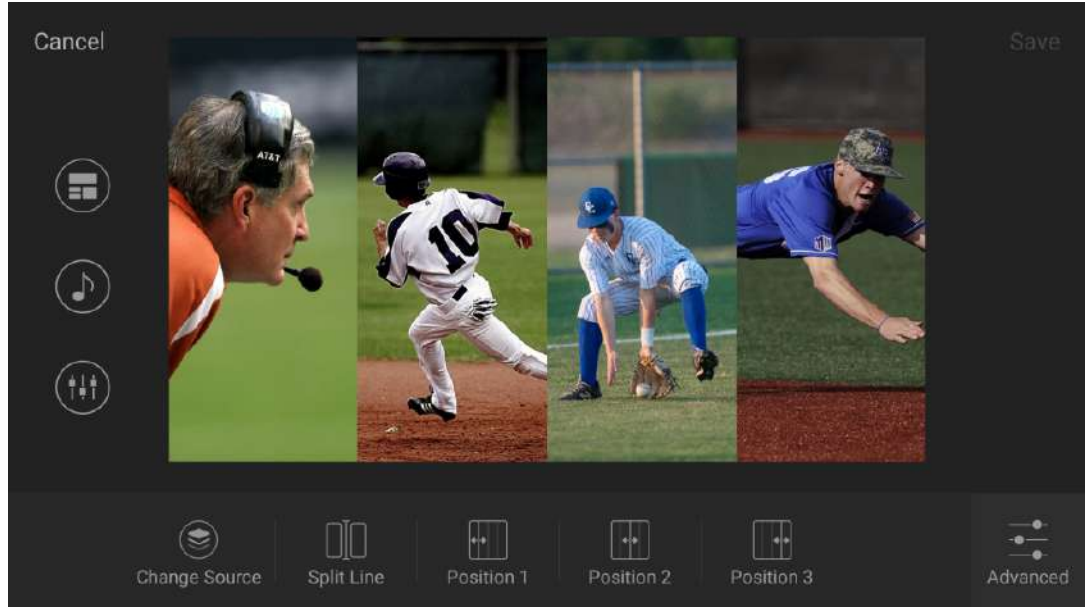

Layout 9

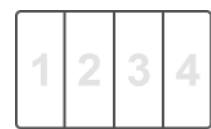





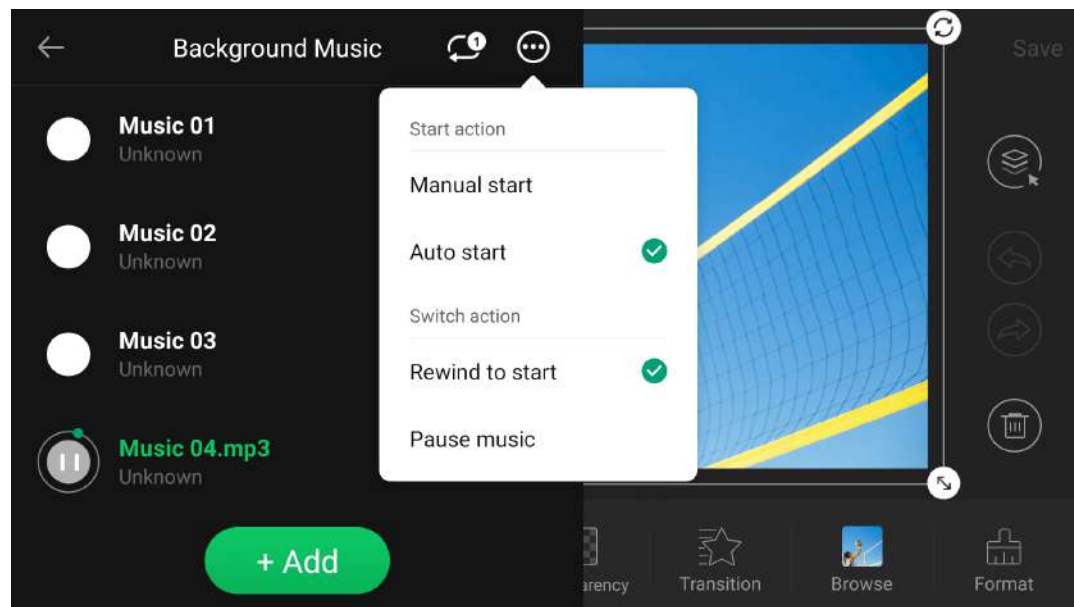
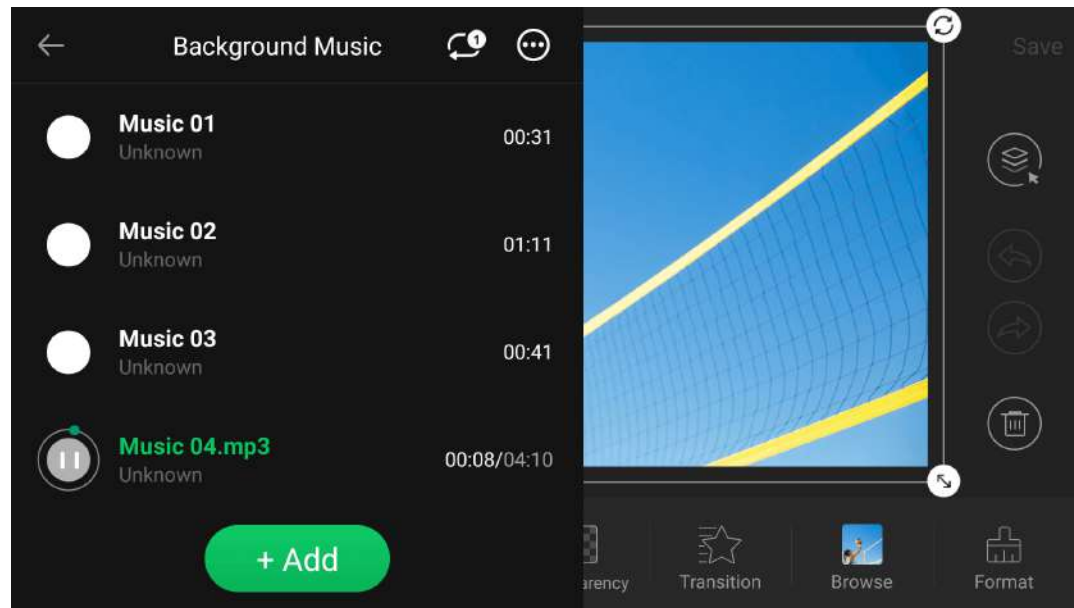

- **Split Line:** show split lines among the four boxes by setting thickness and color. If the thickness is set to zero, the split line is invisible.
- **Position 1/2/3:** drag the slider to change the position of the split lines.

## Background Music

You can add background music to a scene to enrich your scene. Such music is considered as the scene's private BGM. You can also go to Web UI to add global background music to play with the whole show.



1. On the main screen, long press a scene thumbnail and tap **Edit** to open the Scene Editor.
2. Tap , select a storage path, and then select an audio file to add. Then, the **Background Music** page pops out. Supported formats are MP3, M4A, WAV files.
3. Tap **+ Add** to add more songs.
4. Tap on a song to start or pause.
5. Set the music playback policy at the upper right corner.
  -  : Repeat the playlist. (default policy)
  -  : Repeat the selected song.
  -  : Shuffle the playlist.
6. Tap  to set start action and switch action.
  - Start action:
    - Manual start: you need to start playing music manually.
    - Auto start: music starts playing automatically.
  - Switch action:
    - Rewind to start: Replays the song from the beginning.
    - Pause music: Pauses the song when the scene is switched out, and resumes when the scene is switched back.
7. To delete a song, swipe the song to the left and tap .

# Present Your Show



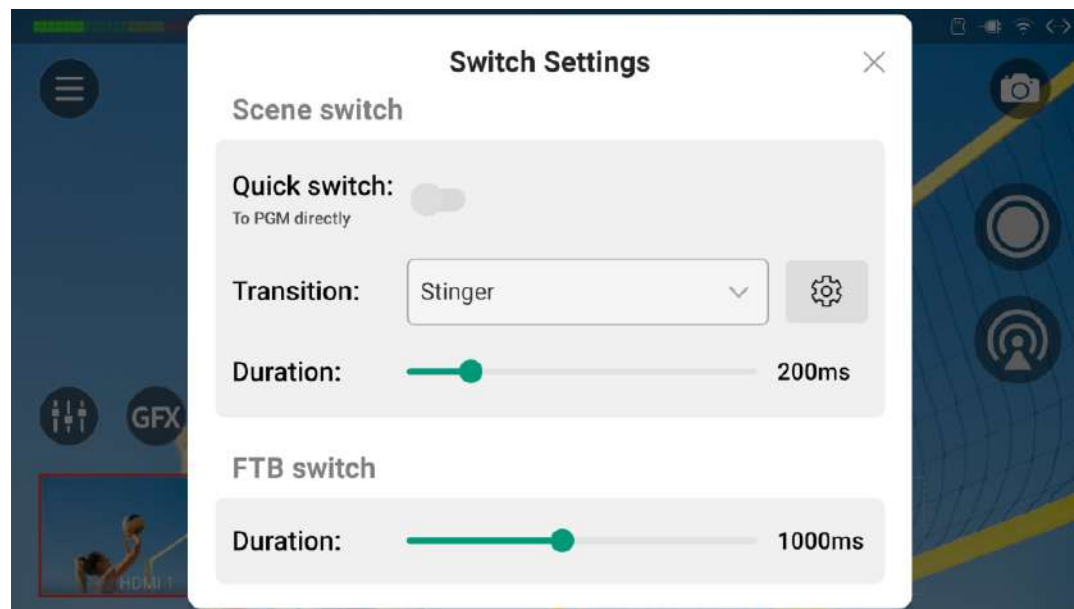

Director device provides lots of tools for conveniently presenting your show and adding eye-catching effects, making your show more professional and attractive.



## Control Scenes

Director device supports switching scenes with quick mode or manual mode.

### Set Switch Mode

1. Tap , and select **Switch Settings**.
2. In the **Scene switch** area, set scene switch mode and transition effect.
  - **Quick switch:** Toggle off the switch, it goes to the manual switch mode. To enable the quick switch mode, toggle on the switch.
  - **Transition:** Select the transition effect.
    - **Cut:** Scenes switch directly. (Default)
    - **Fade:** Scenes switch with the fade effect.
    - **DIP:** Scenes switch with a two-step transition with a color flash in the middle of the transition. Tap  for more settings.
    - **Wipe:** One scene is replaced by another gradually sweeping across the screen. Tap  for more settings.
    - **DVE:** One scene is replaced by another according to a 2D Digital Video Effect (DVE) pattern. Tap  to select a DVE effect.
    - **Stinger:** A stinger is played over the top to cover the transition. Tap  for more settings.

- **3D:** One scene is replaced by another according to a 3D pattern. Tap  to select a 3D pattern.
  - **Duration:** Drag the slider to set the transition duration for effects, ranging from 50ms to 1000ms.
3. In the **FTB switch** area, drag the slider of **Duration** to set the transition duration for **FTB**, ranging from 200ms to 2000ms.
  4. Tap X to exit.

### DIP Settings

- **Onset:** Duration from the current scene to the color flash.
- **Offset:** Duration from the color flash to the next scene.
- **Hold:** Duration that the color flash is held. This value is the residual of the total transition duration minus the onset and offset.
- **Color:** Select a preferred color.

### Wipe Settings

- **Angle:** Set the angle of linear wipe.
- **Line 1/2/3:** By default, the line is invisible. Toggle on the switch to display the line and tap  to set thickness, color and transparency.

### Stinger Settings

- **Thumbnail:** Tap a thumbnail to select a stinger, and tap it again to replace the default stinger with your own one. The stinger should be an MP4, MOV or WebM file within 1 to 5 seconds.
- **Chromakey:** Toggle on Chromakey and set similarity, smoothness and spill, to remove the background.

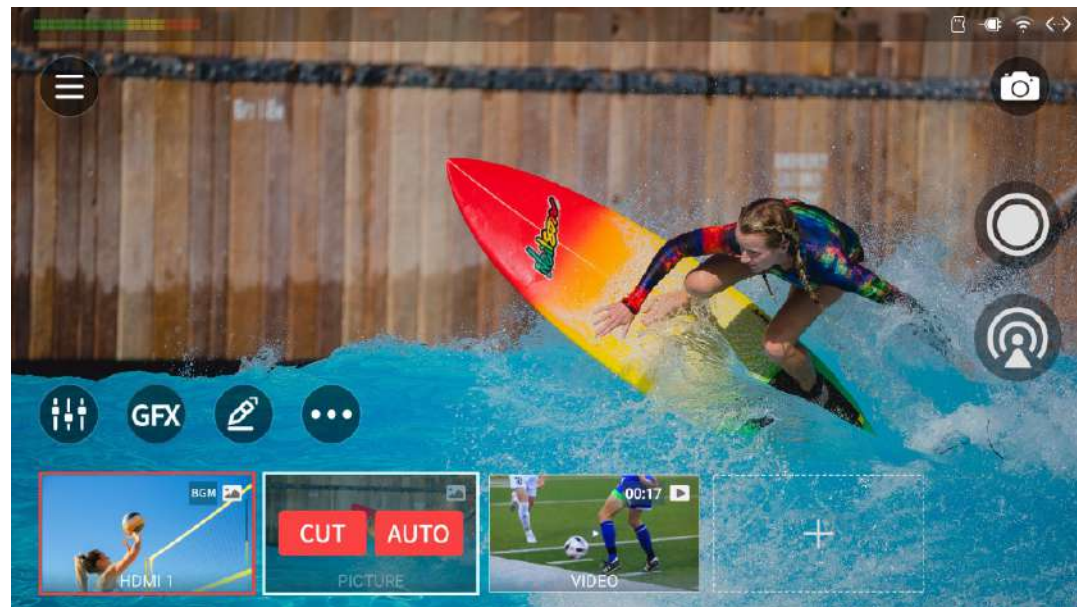

- **Enable audio:** If your video contains audio, you can toggle on **Enable audio** and adjust the audio volume.

You can also change switch settings in the **Settings**. For details, see [Switch](#).

## Switch Scenes

### Quick Switch

When **Quick switch is toggled on**, you can tap thumbnails in the scene list to switch scenes directly.

### Manual Switch

When **Quick switch is toggled off**, it goes to manual switch mode. You can set and preview the content to program. After you confirm everything is OK, you can program the scene.

1. Tap the thumbnail of next scene to program in the scene list. The main screen displays the preview content. The program scene thumbnail has a red frame, while the preview scene thumbnail has a white frame and displays **CUT** and **AUTO** buttons.

The output image is the scene in Program view.

2. Adjust the audio volume, select elements to go with the preview scene to program, such as a GFX, and check everything is OK.

If a video clip is contained in the preview view, it will execute the configured start action and end action. Here are two actions differing from that in the program view.



- If it is set to "Manual start", you can tap the Play button in the center of the video clip to start to play while tap the center again to pause.
  - If it is set to "Switch to scene x", it does not switch when the video clip ends, but displays the last frame.
3. Tap the **CUT** or **AUTO** button on the preview scene thumbnail, and the scene goes to program directly or with the selected transition effect.

If a video clip is contained in the scene, after going to program, it re-executes the configured actions. The play progress in the preview view will not take effect.

## FTB



The **FTB** (Fade to Black) function allows your show to fade into black or fade to image during streaming or recording, with no video nor audio output. This function is most often used at the end of a scene or show.

You can set fading to black or image on the Web UI.

- Tap , and select **FTB**.  
Your audio/video output will be stopped.
- To continue your show, tap  > **FTB**.  
Your show will go back to the screen and continue.



## Freeze Scene

You can freeze dynamic images while streaming or recording.

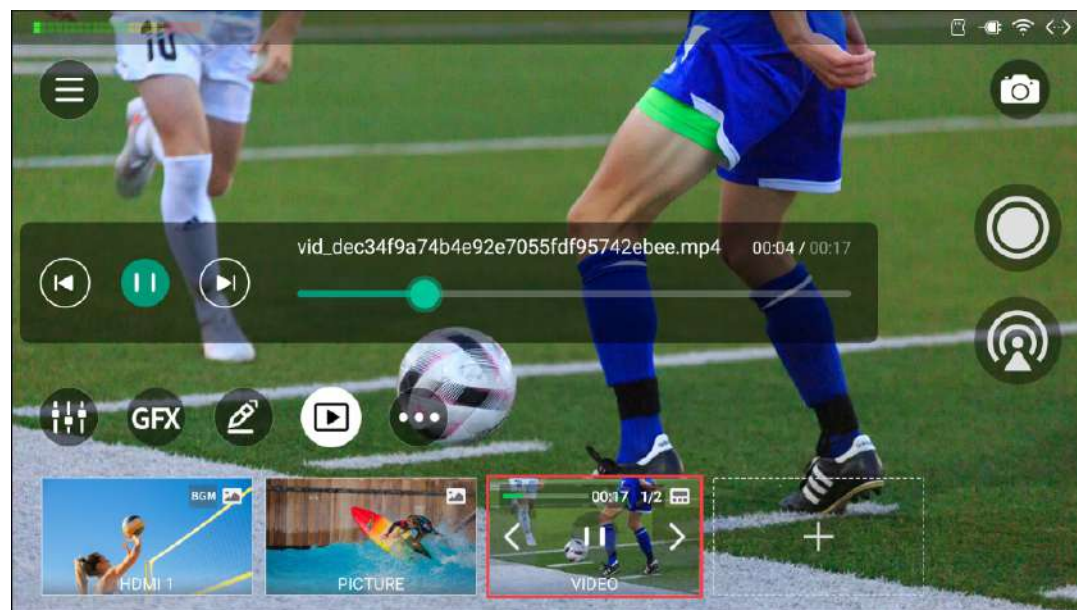
- To freeze the scene, tap  and select **Freeze**.
- To unfreeze the scene, tap  and select **Unfreeze**.





## Toggle Transition

If source layers in a scene is set with entrance and exit transition effects, you can tap  >  **Transition** to toggle transition in or out when the scene is in PGM.

For how to set transition effects, please go to [Transition](#).

## Control Video Playback

When a scene contains a video, its thumbnail displays the duration information. You can tap the play/pause button to control the video. Then, the progress bar of the video will appear on the top of the scene thumbnail.

Also, you can tap  >  **Video** to call out the progress bar to control the playback of video in Program view. For a video slide show, you can tap the left and right arrow to jump to the previous or next video.

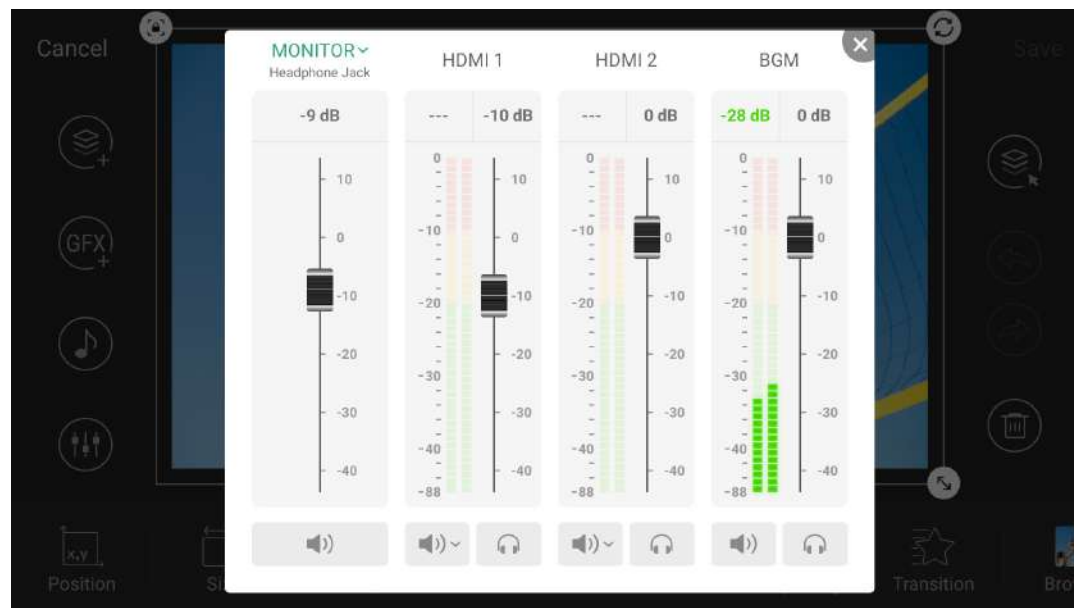
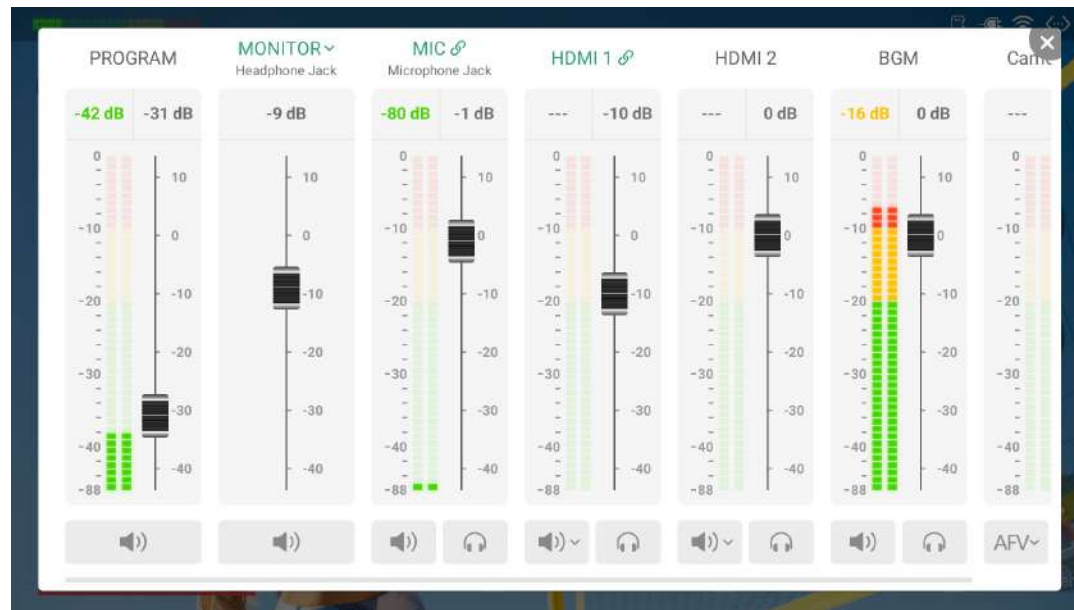

## Control Slide Show

If a scene has a picture or video slide show, you can tap the play/pause button to start or stop the slide show, and use the left/right arrows to turn pages or switch videos.



## Control Volume

The audio mixer is used to mix connected audio sources, external audio sources and built-in audio from BGM and video clips. You can access the audio mixer by the following ways.

- Tap  on the main screen to open the main audio mixer, which displays all the audio inputs and outputs of the current show.
- Long-press a thumbnail on the scene list, select **Edit** on the popup to enter the scene editor, and then tap  to open the scene's audio mixer, which displays the monitor and audio input sources of the current scene.

## Audio Type

Scroll the audio mixer to view all the audio sources.

- **PROGRAM:** Output audio of the program scene, for streaming or recording.
- **PREVIEW:** Output audio of current previewing scene, only displayed during manual switch.
- **MONITOR:** Audio output for monitoring.
- **Audio Input Sources:**
  - **MIC:** Audio of global microphone.
  - **Bluetooth:** Audio from a Bluetooth device, which is displayed when the device is connected with Director device. (You need to [select Bluetooth Audio Input mode](#) in the Settings.)
  - **USB AUDIO:** Audio from a USB device, which is displayed when the device is connected with Director device.
  - **HDMI:** Audio from an HDMI source, which is displayed on the main audio mixer by default.

- **RTMP Stream:** Audio from the **RTMP** stream source, displayed with the self-defined name.
- **SRT Stream:** Audio from the **SRT** stream source, displayed with the self-defined name.
- **RTSP Stream:** Audio from the **RTSP** stream source, displayed with the self-defined name.
- **NDI Stream:** Audio from the NDI stream source, displayed with the self-defined alias.
- **Phone Camera:** Audio from the phone, displayed with the self-defined name.
- **VIDEO CLIP:** Audio embedded in the video clip source, which appears when the current scene containing a video clip. It displays the file name under VIDEO CLIP to distinguish different files.
- **BGM:** Audio of the background music. Usually, it displays the global BGM. When the current scene has private BGM, the global BGM is overridden by the private one.
- **Webpage:** Audio from a webpage source.
- **GFX:** Audio from a GFX, such as webpage, NDI or video GFX, which appears when such GFX is displayed in the show.

### Audio Meter

Except monitor, each audio has its audio meter showing the real-time level. An audio meter of program is also displayed at the upper left corner of the home screen.

The range of the Audio Meter is -88 dB to 0 dB. It displays the peak value at the top of the audio meter (in portrait mode, on the right). Colored blocks and scales indicate the danger of clipping, as shown in the table below.

Color	Scale Range	Description
Green	-88 ~ -40	Audio device is connected.
Green	-40 ~ -20	Audio volume is low.
Yellow	-20 ~ -10	Audio is at normal levels.
Red	-10 ~ 0	Audio is in danger of clipping.



### Adjust Audio Level

Each audio has a fader for adjusting the maximum level.

- Move the fader to set the gain on the audio level. The range is from -40dB to 10dB.
- The current adjusted value is displayed at the top of the fader. Double tap the value to restore the fader to 0dB.

### Set Program Audio

Use the button at the bottom of PROGRAM (in portrait mode, on the right) to turn on or turn off the program output audio.

-  : indicating the program output audio is turned on.
-  : indicating the program output audio is turned off.

## Set Monitor

The monitor has an independent audio level with the default gain of -15 dB. You can set monitor audio without effecting the program output audio.



### Set Monitor Properties

Tap **MONITOR** to set the following properties.



- **Select Device:** select a device as the monitor.
  - Headphone Jack: device connected to the headphone jack.
  - Bluetooth Device: device connected through BT. (You need to [select Bluetooth Audio Output mode](#) in the Settings.)
  - *USB device:* USB device(s) connected to Director device. The system automatically lists device name(s).
- **Monitor Option:**  
Toggle on/off the switch of **MIC Input** to set whether to monitor the microphone. It is toggled on by default.

### Enable/Disable Monitor

Tap the button at the bottom of MONITOR (in portrait mode, on the right) to enable or disable audio monitoring.





-  : indicating audio monitoring is enabled.
-  : indicating audio monitoring is disabled.

### Solo Monitor

- Tap  to only monitor this audio input.
- Tap  to cancel.

## Set Audio Input Sources

### Audio Association State











- When an audio input source is added to multiple scenes, its name is displayed in green on the audio mixer, and you can tap the name to change its association state. It also applies to global input including MIC, Bluetooth and USB audio.
  -  : indicating the audio input is associated with multiple scenes. The settings to this audio input will take effect to all the scenes.
  -  : indicating the audio input is not associated with other scenes. You can customize the audio mixing mode and adjust audio level for each scene.
  - When the state changes from  to  , the settings to this audio input will take effect to the whole show.
- When an audio input source is only contained in one scene, its name is displayed in black on the audio mixer and cannot be tapped. The settings to this audio input will take effect to all the scenes.

When a webpage is added into different scenes or GFXs, it is treated as separate audio input sources, serving as the private audio for each scene or GFX.

### Set Audio Mixing Mode

Tap the icon to set the audio mixing mode of each audio input source.

- When the audio input source is in  state, or is only added in one scene, or is a webpage,

-  : Audio-follow-video. The audio will only be sent to the program output when the input is in program view.
-  : Always ON. An audio input will be permanently mixed into the program output.
-  : Always OFF. An audio input will be permanently not mixed into the program output.
- When it is private BGM, Video Clip, or other audio input source in  state
  -  : ON. When the current scene is in program view, the audio will be sent to the program output.
  -  : OFF. When the current scene is in program view, the audio will not be sent to the program output.
- When it is global BGM,
  -  : Always ON. It will be mixed into the program output.
  -  : Always OFF. It will be not mixed into the program output.
- When it is GFX audio,
  -  : ON. When the GFX is applied, the audio will be sent to the program output.
  -  : OFF. When the GFX is applied, the audio will not be sent to the program output.

If you connect a Magewell USB Capture device to Director device, the USB audio supports AFV. For other USB devices, they do not support AFV.





If the current scene is in Preview view, the PROGRAM audio changes to

**PREVIEW.**

All the audio settings in the Preview view will take effect after the scene goes to Program.

## Use Magewell USB Capture

When a Magewell USB Capture is connected to Director device, you can control the embedded audio from the input signal and microphone/Line In audio.

- Embedded audio from the input signal: support setting  and  state. Please refer to [Set Audio Input Sources](#).
- Microphone/Line In audio:
  -  : ON. The audio input will be permanently mixed into the program output.
  -  : OFF. The audio input will be permanently not mixed into the program output

You can set more audio properties through "  > Settings > Audio". For details, see [Audio](#).

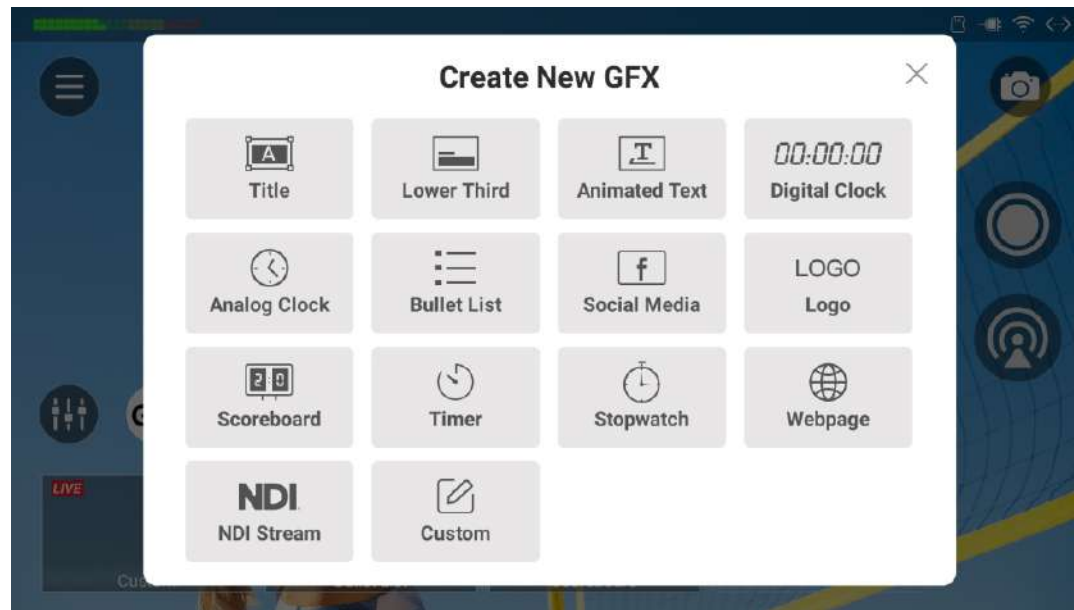

## Use GFX



Graphic Overlay (GFX) enables a predefined logo, picture and text combination to show on the scene during recording and streaming. It is ideal for adding professional elements like lower thirds or company logos to your show, enhancing its visual appeal and interactivity. A variety of pre-designed templates help you create GFX quickly and easily. You can also create GFX from scratch by using a webpage, NDI stream, HDMI source, Webcam source, video clip, PAG file, etc.





You can create GFX for global use, which can be applied at any time during your show. You can also create a private GFX specific to a scene by tapping the  button in the scene editor. The private GFX will only be displayed when the scene is in program view.

- Each scene can only include one of the following: a scoreboard, timer, or stopwatch. These cannot be duplicated or added simultaneously.
- You can add up to four private GFXs in a single scene.

The following sections use global GFX as an example to demonstrate how to create different types of GFX.

### Create GFX with Template

1. Tap  to open the GFX list.
2. Tap  to open the **Create New GFX** interface.
3. Select a GFX type.
4. Select a template to enter the editor.
5. Edit the GFX by referring to [GFX Templates](#).
6. Adjust the GFX size, rotation and position. For details, refer to [editing tools](#).

7. Tap the bottom left button to change the background, aiding in positioning the GFX.
  -  : Transparent.
  -  : Program scene with active GFX (if any).
  -  : Gridlines.
8. Tap  at the left to change template if needed.

Whether the template is changeable depends on the GFX type.

9. (Optional) Set timing, which makes the GFX disappearing automatically.
  - a. Tap  on the left.
  - b. Toggle on Timing.
  - c. Scroll time options to set the duration.
  - d. Tap Confirm.
10. Tap **Save**, and the GFX thumbnail appears in the GFX list.

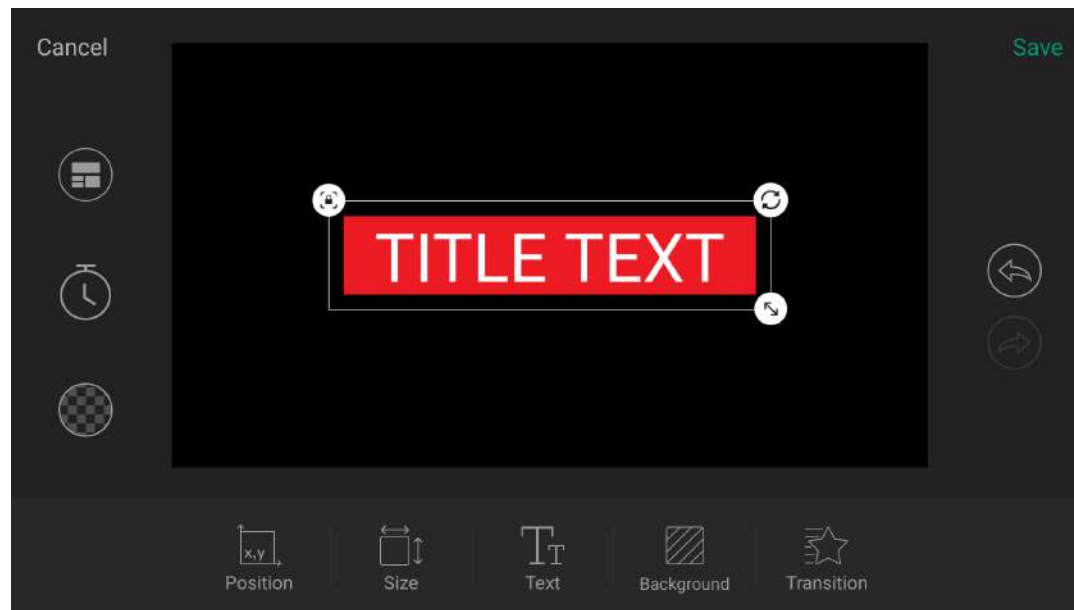

## GFX Templates

Director device provides various GFX templates helping you display more information during program.

### Title

A title shows the theme of your show, and a good title will make your show more engaging. It provides general and animated title templates.

#### General

1. Tap text boxes and enter content.
2. Set text format, background and transition effect. See [Editing Tools](#) for details.

#### Animation

Tap **Title (X)** to enter text and set size, color, font and case. Different templates contain different editable elements.

You can add a total of three animated GFXs, including animated title, animated lower third and PAG.

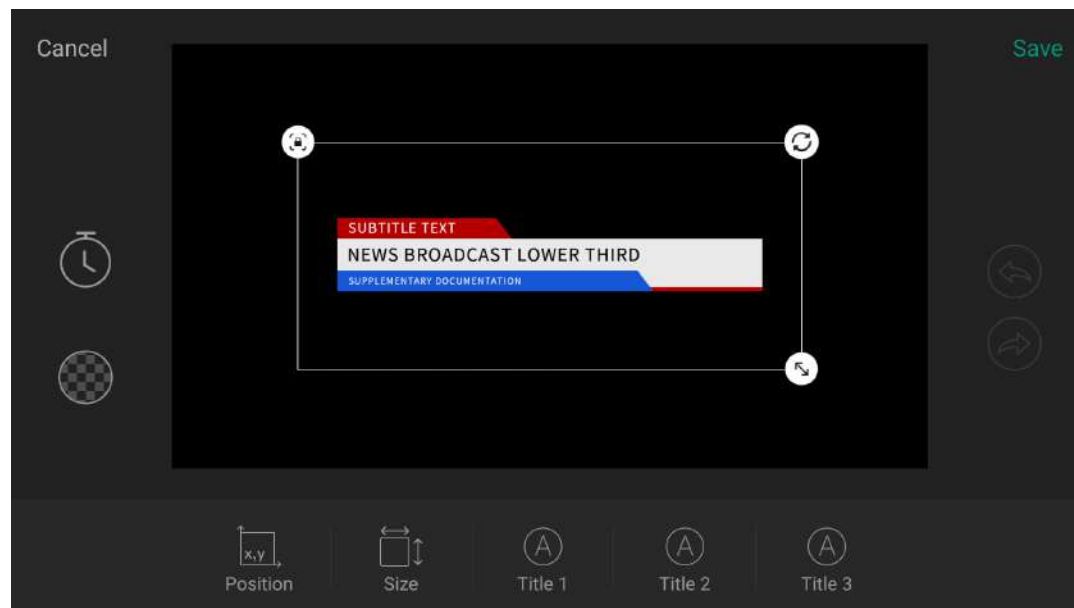
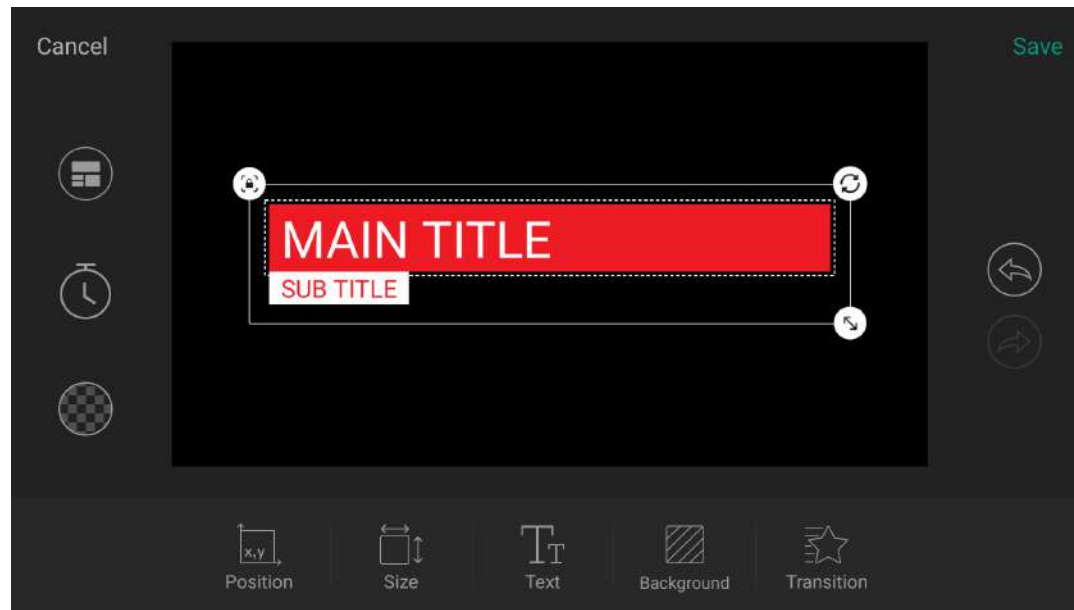

## Lower Third

Lower third is often used to show the name of who is talking or to give vital information about an event. It provides general and animated lower third templates.

### General

1. Tap text boxes and enter content.
2. Set text format, background and transition effect. See [Editing Tools](#) for details.

### Animation

Tap **Title (X)** to enter text and set size, color, font and case. Different templates contain different editable elements.

You can add a total of three animated GFXs, including animated title, animated lower third and PAG.

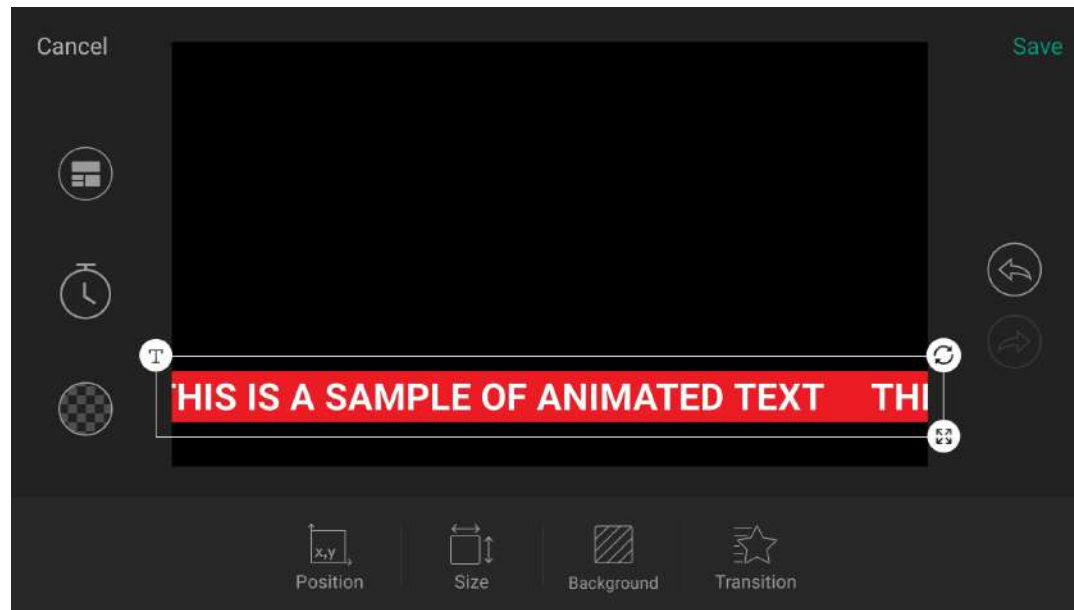

## Animated Text

Animated text crawls horizontally for displaying sports news, breaking news, weather report, etc.

1. Tap the text box, and then enter content, or tap **Import** at the upper right corner to import from a .txt or .rtf file. It supports up to 1024 characters. If the imported text has line breaks, you can select to import the first paragraph or import all paragraphs with line breaks being deleted automatically.
2. Set text format, background and transition effect. See [Editing Tools](#) for details.

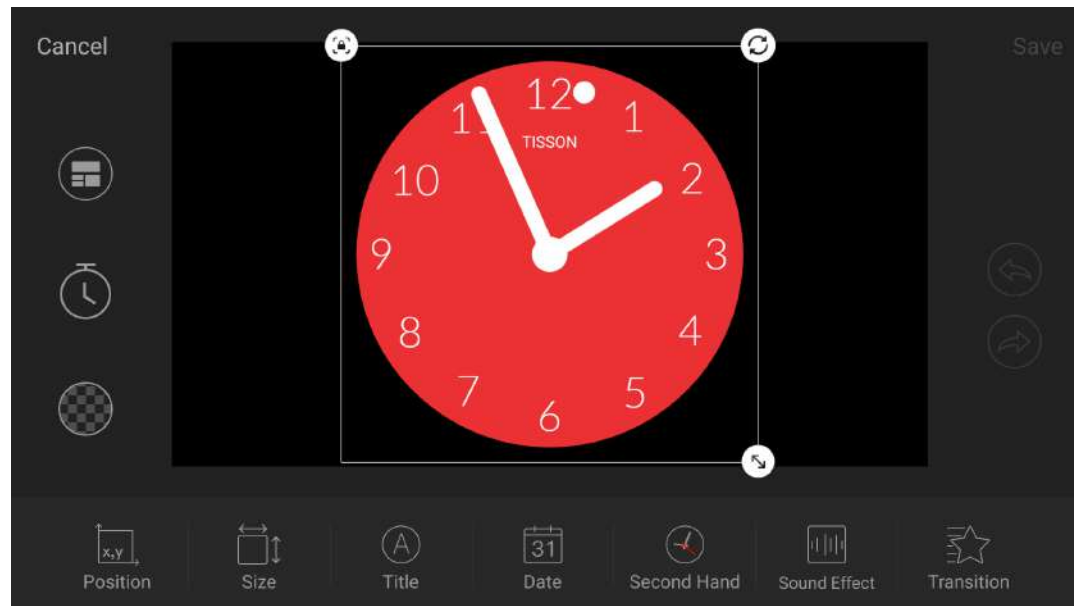

## Analog Clock

Analog Clock displays a clock, which can be embedded with date and other information.

- **Title:** Set whether to show the title, and edits the title's name, font, size, and transparency.
- **Date:** Set whether to show date and selects date format.
- **Second Hand:** Set the second hand mode. Options include No second, Sweeping second and Jumping second.
- **Sound Effect:** Set the clock's sound effect. Options include: None (default), Modern, Old, Crisp, Ticktock and Tradition.
- **Transition:** Set transition effect.

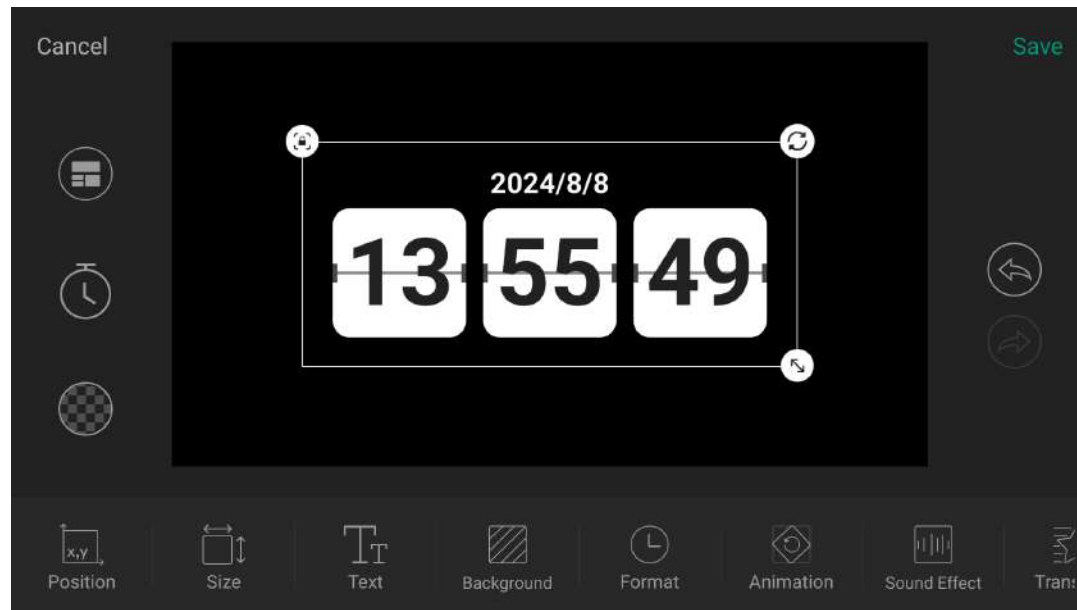

## Digital Clock

Digital Clock displays digital date and time, which are synchronized with the system.

- **Text:** Set the number's color, size, font and transparency.
- **Background:** Specify a solid color, gradient color or picture as the clock's background, and sets the transparency.
- **Format:** Toggle on/off the switches to enable or disable the following properties, and then tap Save.
  - 24 hour clock
  - Show seconds
  - Show colon
- **Animation:** Set the clock's animation effect. Options include Classic, Flip, Gradient, Drop and Swivel.
- **Sound Effect:** Set the clock's sound effect. Options include: None (default), Modern, Old, Crisp, Ticktock and Tradition.
- **Transition:** Set transition effect.

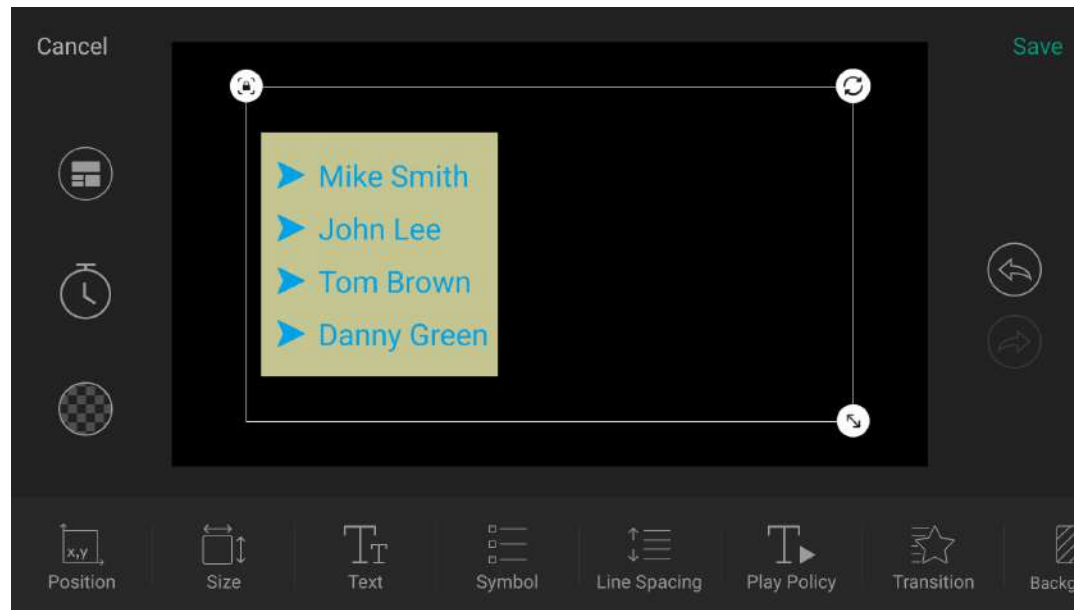

## Bullet List

Bullet List can list important information clearly.

1. Tap the text box, enter your content, and tap Enter to add a new item. To delete one list item, delete all the content of this item.
2. Set properties of the bullet list.
  - **Text:** Set the text's format, including font, size, color, case, transparency and shadow.
  - **Symbol:** Set the symbol's style, size and color.
  - **Line Spacing:** Set the vertical space between the lines.
  - **Play Policy:** Set how to play list items when the list is displayed.
    - **Play policy:** You can set to play "All at once", that is, all list items appear together; or play "By paragraph", that is, list items appear one by one.
    - **Play mode:** When playing by paragraph, you can choose "Auto Play", that is, the list items will be played automatically according to the set "Play speed"; or choose "Manual Play", that is, after the list is applied, you can tap the screen to display list items one by one.
    - **Play speed:** Set the play speed for auto play. Options include very slow, slow, medium, fast and very fast.
    - **Play effect:** Set the play effect of list items appearing by paragraph. Options include none, fade, fly in, expand, zoom in, and typewriter.
  - **Transition:** Set transition effect.
  - **Background:** Specify a solid color, gradient color or picture as the bullet list's background, and set the transparency.

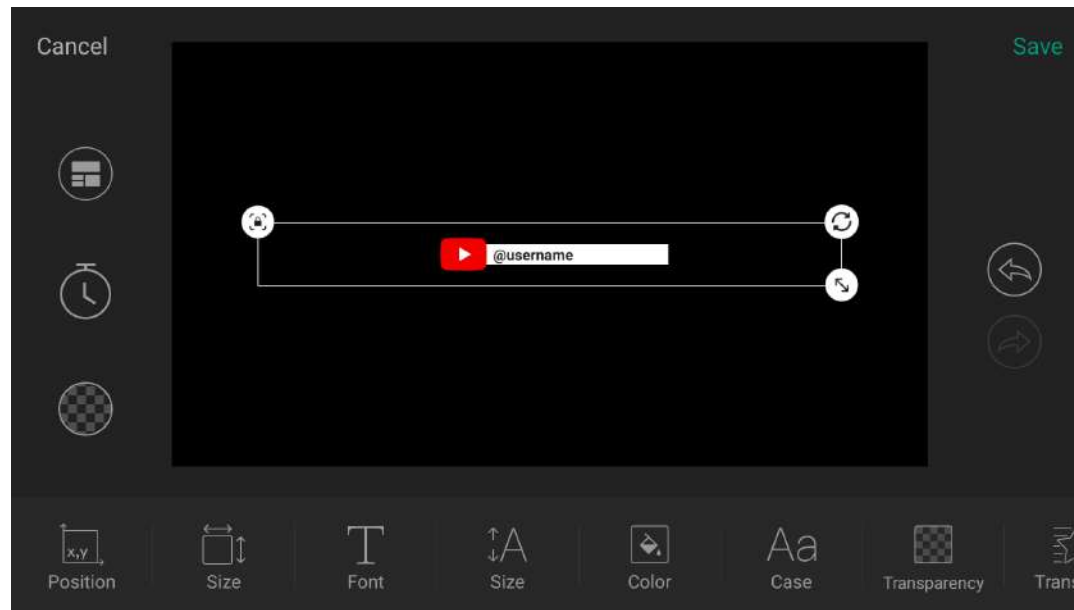

## Social Media

Social Media displays your account to attract more followers.

1. Tap text box and enter content.
2. Set text format and transition effect. See [Editing Tools](#) for details.

The logo cannot be changed. You can switch by changing the template.

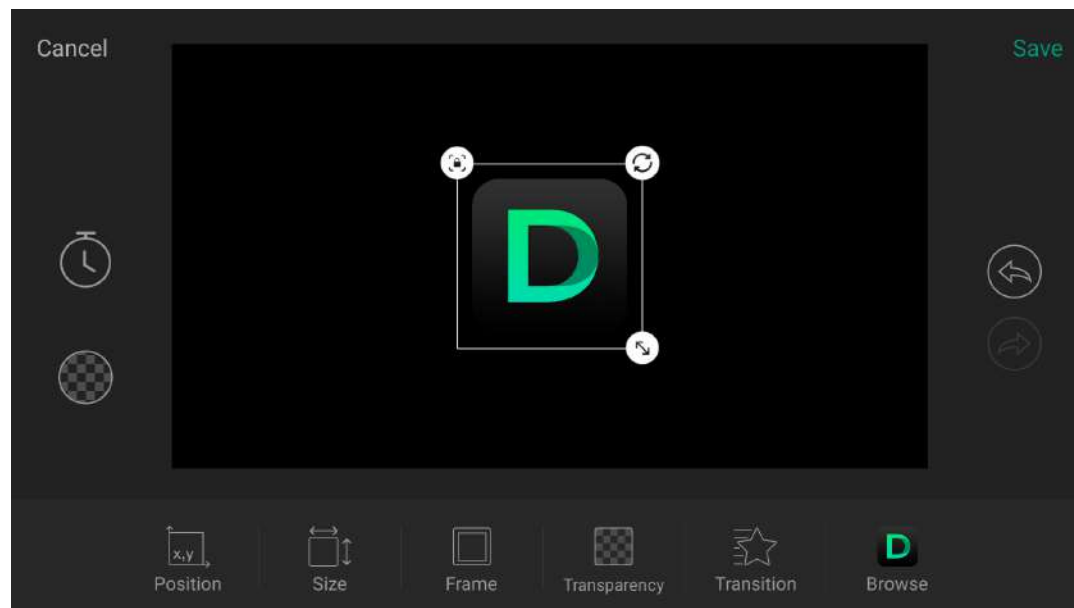

## Logo

Logo supports to import one picture, such as a company logo and brand logo. The supported formats include JPG, PNG and BMP.

1. Select a picture from the storage.
2. Set the picture's frame, transparency and transition effect. See [Editing Tools](#) for details.

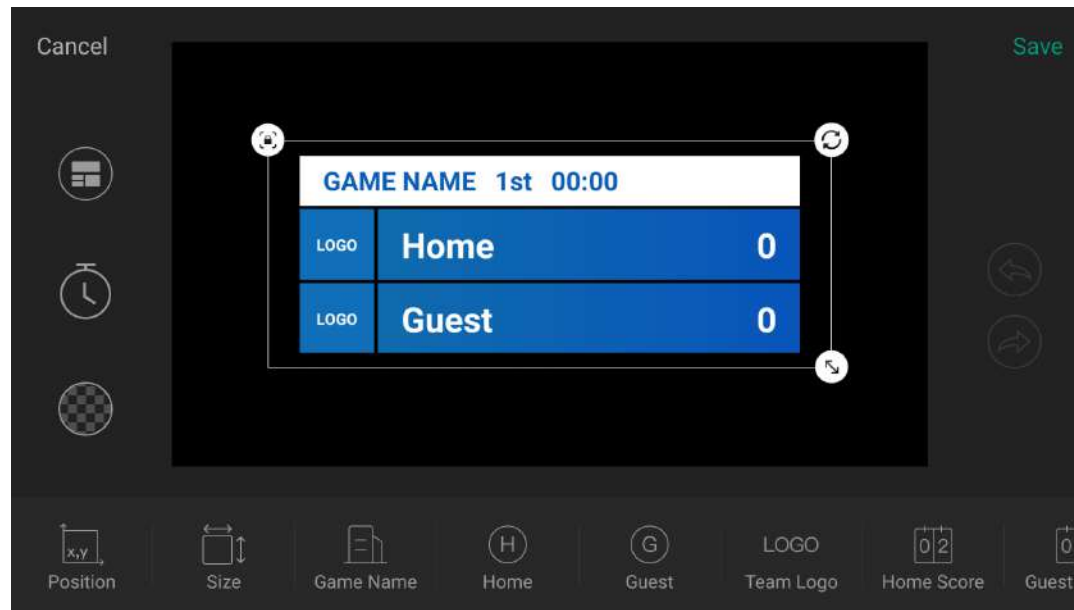

## Scoreboard

Scoreboard displays the scores of a game. It currently provides general, baseball and soccer scoreboard templates.

### General Scoreboards

#### Basic Settings

- **Game Name:**
  - Toggle on/off the switch of **Show Name** to set whether to show the game name.
  - Set game name's content, font, size, color, transparency, and background.
- **Home:** Set the home team's name, text font, size, color, transparency and background.
- **Guest:** Set the guest team's name, text font, size, color, transparency and background.
- **Team Logo:**
  - Toggle on/off the switch of **Show Logo** to set whether to show team logos.
  - Set the home logo and guest logo, and adjust their size.
- **Home Score:** Set font, size, color, transparency and background for the home team's score. Whether the score background can be set is determined by the template.
- **Guest Score:** Set font, size, color, transparency and background for the guest team's score. Whether the score background can be set is determined by the template.
- **Transparency:** Set the transparency of the scoreboard.

- **Transition:** Set transition effect.

### Advanced Settings

Tap **Advanced** to further customize the scoreboard.

- **Show game name:** Toggle on/off the switch to set whether to show game name.
- **Show game time:** Toggle on/off the switch to set whether to show game time. When it is toggled on, the Countdown option appears, and you can make the following settings.
  1. Toggle on/off the switch to set whether to enable countdown.
  2. Tap the number and scroll time options to set the duration.
- **Game time format:** Select a preferred format.
- **Show period:** Toggle on/off the switch to set whether to show period. When the switch is toggled on, the **Period name** option appears, tap to open the period list and make the following settings.
  - **Add period:** Tap "+ Add", enter the period name, and tap "Save".
  - **Select period:** Tap any period as the current period. The default periods include 1st, 2nd and 3rd.
  - **Delete period:** Swipe a period to the left, and then tap "Delete".
- **Score step:** Tap "+" or "-" to set the score to add each time. The default value is 1.
- **Allow negative score:** Tap on/off the switch to set whether to allow the score being lower than 0.

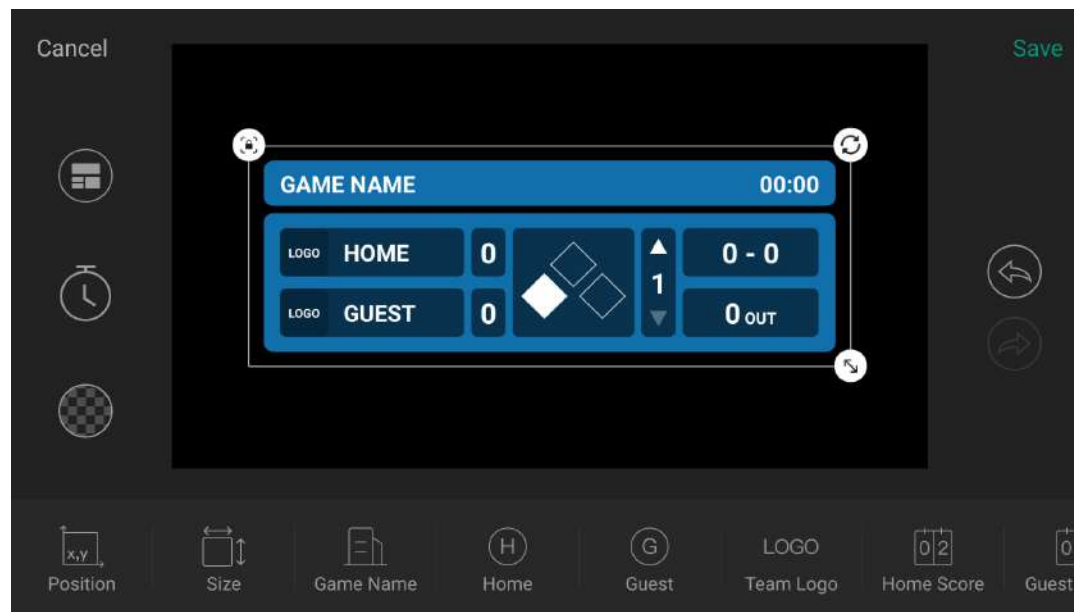

## Baseball Scoreboard

The baseball scoreboard can show lots of elements for easy control.

Select a baseball scoreboard from scoreboard template library, and then start customizing your own layout.

### Basic Settings

- **Game Name**
  - Toggle on/off the switch of **Show Name** to set whether to show the game name.
  - Set game name's content, font, size, color, transparency, and background.
- **Home:** Set the home team's name, text font, size, color, transparency and background.
- **Guest:** Set the guest team's name, text font, size, color, transparency and background.
- **Team Logo:** Whether the team logo can be set is determined by the template.
  - Toggle on/off the switch of **Show Logo** to set whether to show team logos.
  - Set the home logo and guest logo, and adjust their size.
- **Home Score:** Set font, size, color, transparency and background for the home team's score.
- **Guest Score:** Set font, size, color, transparency and background for the guest team's score.
- **Inning:** Set font, size, color, transparency and background for innings.
- **Out:** Set font, size, color, transparency and background for outs.
- **Ball-Strike:** Set font, size, color, transparency and background for balls and

strikes.

- **On Base Runners:** Set color, transparency and background for on-base runner indicators.
- **Background:** Set background for the baseball scoreboard. Whether the background can be set and the extent to which it takes effect is determined by the template.
- **Transparency:** Set the transparency of the scoreboard.
- **Transition:** Set transition effect.

### Advanced Settings

Tap **Advanced** to further customize the scoreboard.

- **Show game name:** Toggle on/off the switch to set whether to show game name.
- **Show game time:** Toggle on/off the switch to set whether to show game time. When it is toggled on, the Countdown option appears, and you can make the following settings.
  1. Toggle on/off the switch to set whether to enable countdown.
  2. Tap the number and scroll time options to set the duration.
- **Game time format:** Select a preferred format.
- **Show Inning:** Toggle on/off the switch to set whether to show Inning.
- **Show Outs:** Toggle on/off the switch to set whether to show Outs.
- **Show Ball-Strike:** Toggle on/off the switch to set whether to show Ball-Strike.
- **Show On-Base Runners:** Toggle on/off the switch to set whether to show On-Base Runners.

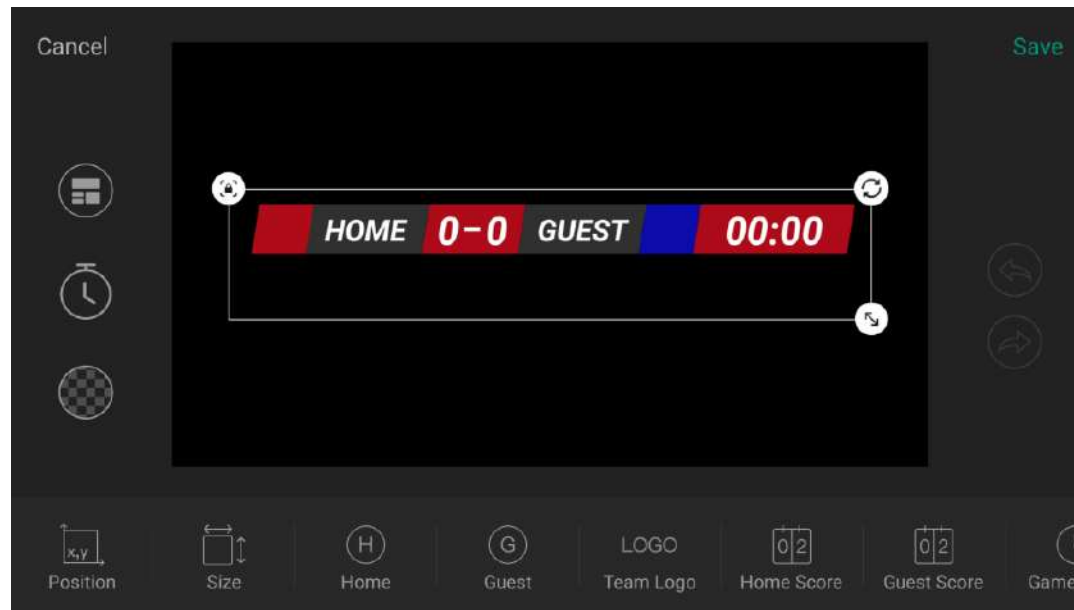

## Soccer Scoreboards

Select a soccer scoreboard from scoreboard template library, and then start customizing your own layout.

- **Game Name:**
  - Toggle on/off the switch of **Show Name** to set whether to show the game name.
  - Set game name's content, font, size, color, transparency, and background.
- **Home:** Set the home team's name, text font, size, color, transparency and background.
- **Guest:** Set the guest team's name, text font, size, color, transparency and background.
- **Team Logo:**
  - Set whether to show team logos.
  - Set the home logo and guest logo, and adjust their size.
  - Set the background color of home and guest logos.
- **Home Score:** Set font, size, color, transparency and background for the home team's score. Whether the score background can be set is determined by the template.
- **Guest Score:** Set font, size, color, transparency and background for the guest team's score. Whether the score background can be set is determined by the template.
- **Game Time:**
  - Set whether to show the game time.
  - Set font, size, color, transparency and background for the game time.

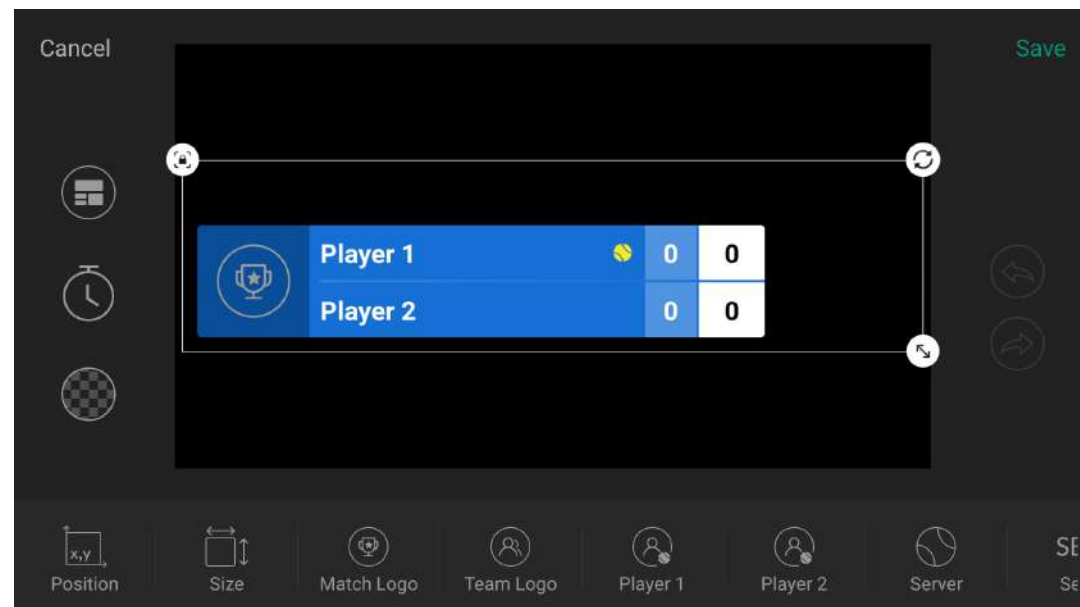

- **Transparency:** Set the transparency of the scoreboard.
- **Transition:** Set transition effect.

## Tennis Scoreboards

Select a tennis scoreboard from scoreboard template library, and then start customizing your own layout.

### Basic Settings

- **Match Logo:**
  - Set whether to show the match logo.
  - Set the logo by selecting a picture from the storage.
  - Adjust log size.
  - Set the background color of the logo.
- **Team Logo:**
  - Set whether to show team logos.
  - Set the logos of player 1 and player 2, and adjust their size.
  - Set the background color of the two logos.
- **Player 1:** Set the name of player 1, text font, size, color.
- **Player 2:** Set the name of player 2, text font, size, color.
- **Server:** Set the color of the server icon.
- **Sets:** Set font, size and color for sets.
- **Games:** Set font, size, color and background for games.
- **Points:** Set font, size, color and background for points.

- **Message:** Set font, size, color and background for message.
- **Background:** Set the color and transparency of the scoreboard background.
- **Transition:** Set transition effect.

### Advanced Settings

Tap **Advanced** to further customize the scoreboard.

- **Number of Sets:** Select the match format.
- **Games per Set:** Select the number of games required for a player to win a set.
- **Advantage Scoring (AD):** Enable advantage scoring when the game reaches deuce.
- **Tiebreak:** Enable a tiebreak when the set score reaches 6–6. A player wins the tiebreak by scoring at least 7 points with a 2-point lead.
- **Auto Message:** Set whether to display messages automatically. When enabled, notifications for game point, break point, and match point will appear automatically as the match progresses.
- **Final Set:** Select the rule for the final set.
  - **None:** A player must win the final set by leading by 2 games.
  - **Tiebreak (7 points):** At 6–6, a player wins by scoring at least 7 points with a 2-point lead.
  - **Tiebreak (10 points):** At 6–6, a player wins by scoring at least 10 points with a 2-point lead.
  - **Super Tiebreak:** If the match score reaches 1–1 (best of 3) or 2–2 (best of 5), the final set is replaced by a tiebreak played to 10 points, with a 2-point lead required.

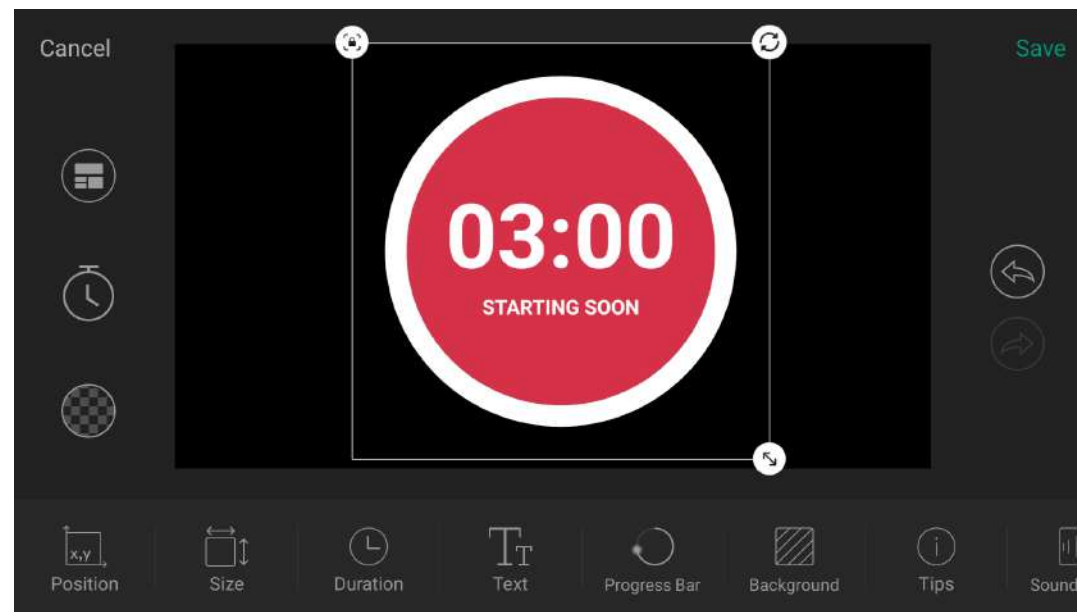

## Timer

You can use a Timer to countdown.

- **Duration:** Scroll hour, minute and second options to set the duration.
- **Text:** Set the font, size, color, and transparency of numbers.
- **Progress Bar:** Set the color of progress bar.
- **Background:** Set the color and transparency of background.
- **Tips:** add some custom tips under the numbers.
  - Toggle on/off the switch of **Show** to set whether to show tips.
  - Set the content, font, size, color and transparency of tips.
- **Sound Effect:** Set the timer's sound effect. Options include: None (default), Modern, Old, Crisp, Ticktock and Tradition.
- **Policies:** Set the policies of timer.
  - When the timer is displayed, you can set "Manual start" or "Auto start".
  - When the timer is hidden, you can select one policy.
    - Auto pause: If the timer is counting, it pauses.
    - Ignore: If the timer is counting, it continues counting; if the timer is not counting, it does not count.
    - Reset: The timer is restored to the set duration.
  - When the timer reaches zero, you can set to hide the timer.
  - When the timer reaches zero, you can also set to switch to another scene. After toggling on the switch, tap "Switch to", and select a scene. When the timer counts down to the last 10s, the scene to switch to will be highlighted with a flashing yellow frame, a LIVE SOON mark and a countdown clock.

- **Alert:** You can set different color for the last a few minutes or seconds to alert the coming event.
  - Toggle on/off the switch of **Enable** to set whether to enable the alert.
  - Set the duration, text color, progress bar color and background color.
- **Transition:** Set transition effect.

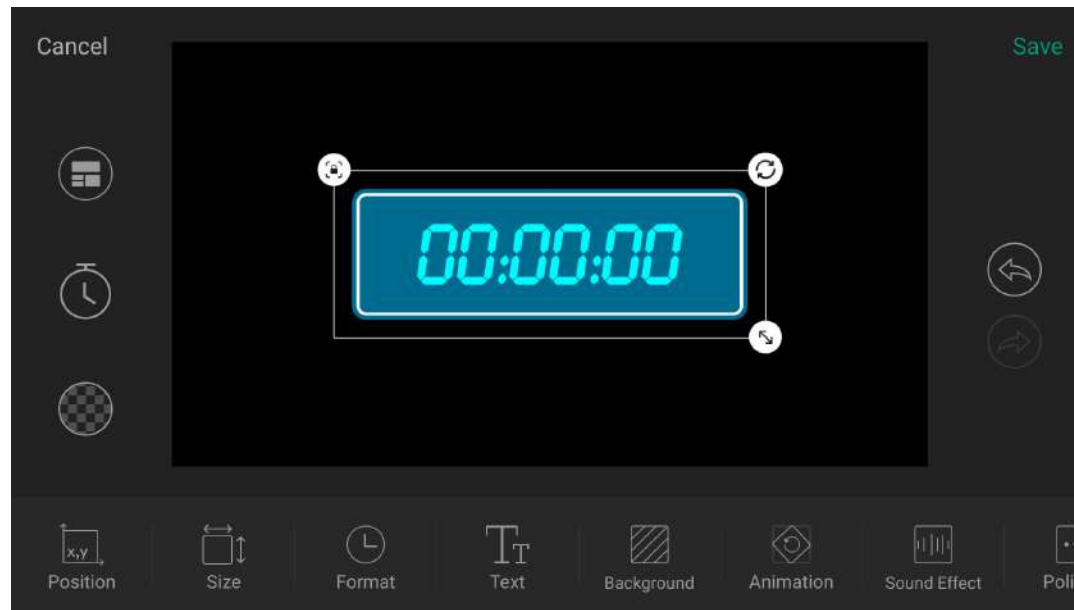





## Stopwatch

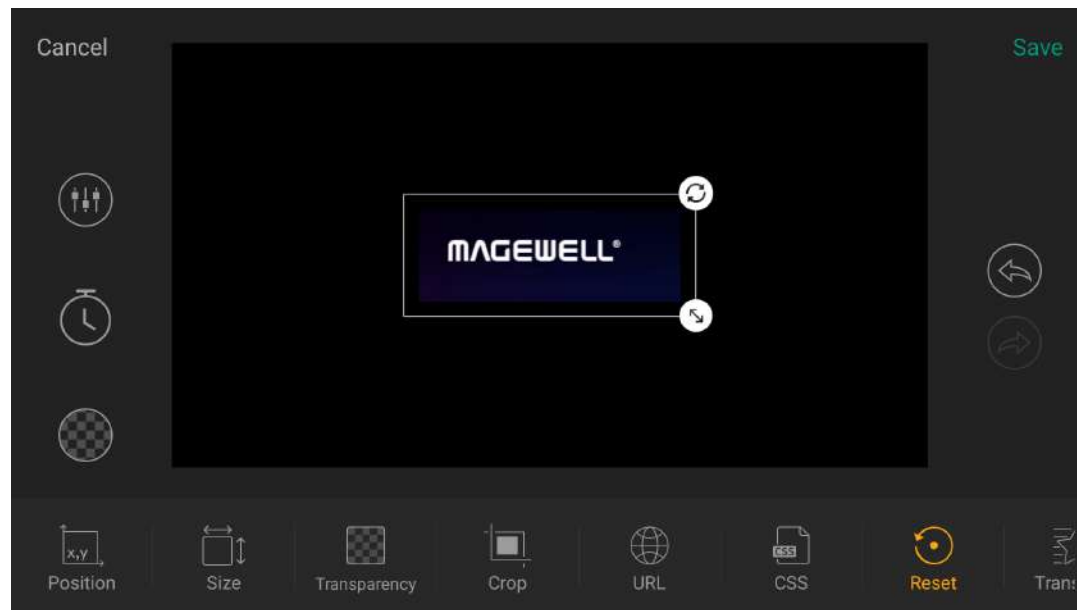



You can use Stopwatch to count up.

- **Format:** Select one stopwatch format. Options include H:M and H:M:S.
- **Text:** Set the font, size, color, and transparency of numbers.
- **Background:** Specify a solid color, gradient color or picture as the background, and sets the transparency.
- **Animation:** Select an animation effect for the numbers. Options include classic, flip, gradient, drop, and swivel. After you select an effect, the stopwatch will count three seconds to show the effect for preview.
- **Sound Effect:** Set the stopwatch's sound effect. Options include: None (default), Modern, Old, Crisp, Ticktock and Tradition.
- **Policies:** Set the policies of stopwatch.
  - When the stopwatch is displayed, you can set "Manual start" or "Auto start".
  - When the stopwatch is hidden, you can select one policy.
    - Auto pause: If the stopwatch is counting, it pauses.
    - Ignore: If the stopwatch is counting, it continues counting; if the stopwatch is not counting, it does not count.
    - Reset: The stopwatch is restored to zero.
- **Transition:** Set transition effect.



## Create Webpage GFX

1. Tap  to open the GFX list.
2. Tap  to open the **Create New GFX** interface.
3. Choose **Webpage**.
4. Enter a URL, and tap **Go** or **Confirm**.
5. Tap the bottom left button to change the background, aiding in positioning the GFX.
  -  : Transparent.
  -  : Program scene with active GFX (if any).
  -  : Gridlines.
6. Edit the webpage in the GFX editor.
  - Adjust the GFX size, rotation and position. For details, refer to [editing tools](#).
  - **Transparency**: adjust the webpage's transparency.
  - **Crop**: crop the webpage, referring to [Crop](#).
  - **URL**: change the URL and tap **Save**.
  - **CSS**: select a CSS option to set the background of webpage.
    - Default CSS: Use the default background of the webpage.
    - Transparent CSS: Change the background to transparent.
    - Custom CSS: Enter your own CSS, or tap **Import** to import a CSS file from the storage, and then tap **Save**.
  - **Reset**: clear all the changes.







7. Tap  to adjust the GFX's volume, referring to [Control Volume](#).
8. (Optional) Set timing, which makes the GFX disappearing automatically.
  - a. Tap  on the left.
  - b. Toggle on Timing.
  - c. Scroll time options to set the duration.
  - d. Tap Confirm.
9. Tap **Save**, and the webpage thumbnail appears in the GFX list.
10. To edit a webpage, tap , select **Webpage**, and tap a thumbnail in the History to enter the GFX editor. Or, you can refer to [Edit GFX](#).
11. To delete a webpage, tap , select **Webpage**, long-press a thumbnail in the History, tap , and confirm to delete in the popup.

It is not recommended to add a video URL as it will consume a lot of system resources.

You can add up to create webpage GFXs. When it reaches 7, you cannot delete webpage history by tapping .



## Create NDI GFX





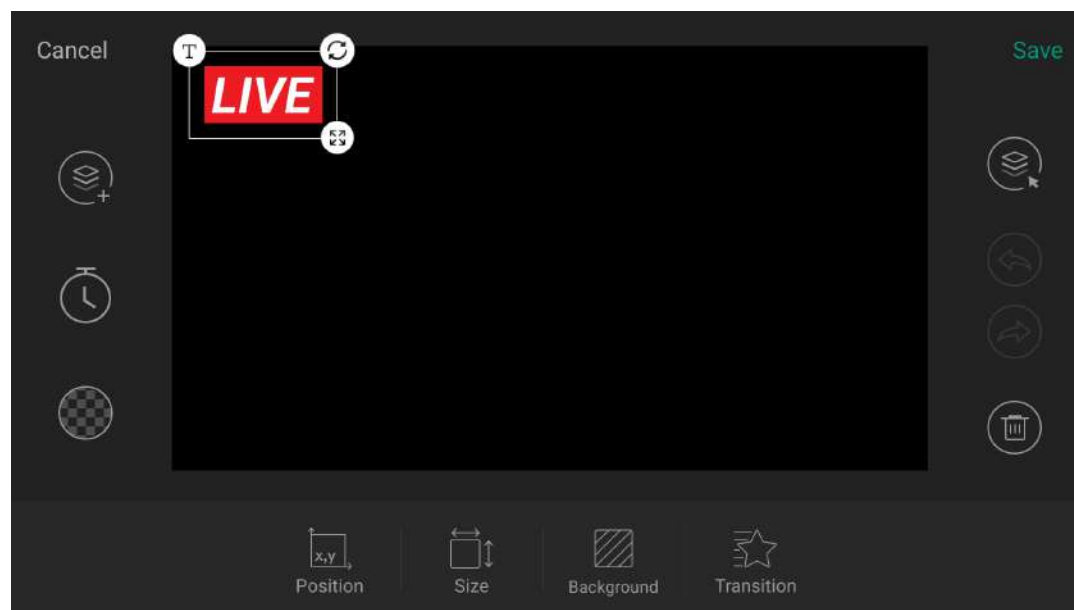
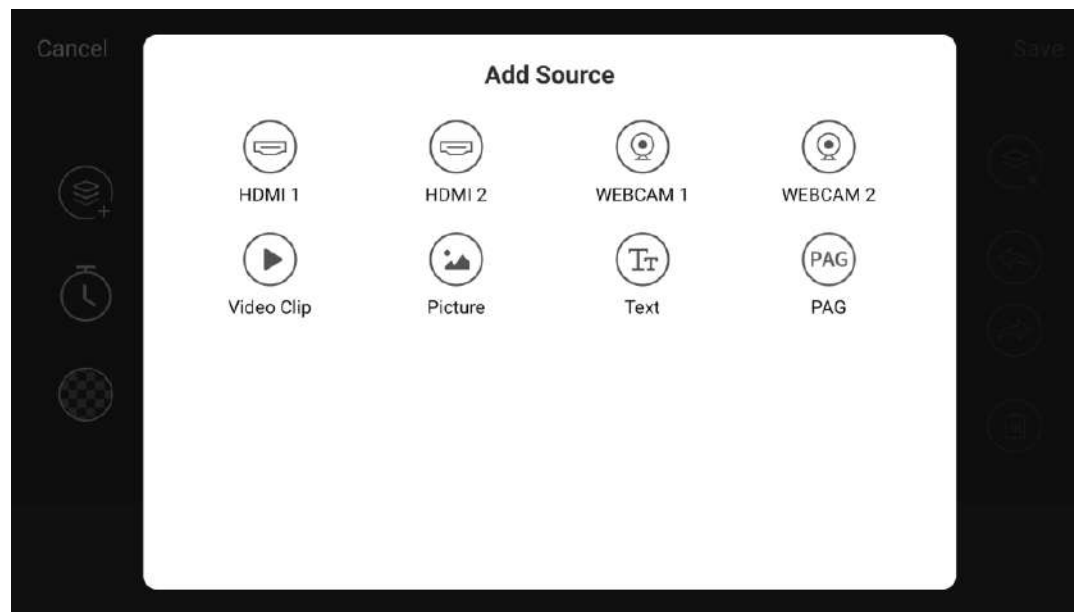

1. Tap  to open the GFX list.
2. Tap  to open the **Create New GFX** interface.
3. Choose **NDI Stream**.
4. Select the NDI source by referring to [Add NDI Stream](#).
5. Tap the bottom left button to change the background, aiding in positioning the GFX.
  -  : Transparent.
  -  : Program scene with active GFX (if any).
  -  : Gridlines.
6. Edit the GFX in the editor.
  - Adjust the GFX size, rotation and position. For details, refer to [editing tools](#).
  - **Transparency**: adjust the source's transparency.
  - **Crop**: crop the source.
  - **URL**: change the NDI source's property.
  - **Reset**: clear all the changes, not including transition.
  - **Transition**: set the transition effect.
7. Tap  to adjust the GFX's volume, referring to [Control Volume](#).
8. (Optional) Set timing, which makes the GFX disappearing automatically.
  - a. Tap  on the left.
  - b. Toggle on Timing.

- c. Scroll time options to set the duration.
  - d. Tap Confirm.
9. Tap **Save**, and the thumbnail appears in the GFX list.



## Create Custom GFX

You can add HDMI, WEBCAM, Video clip, picture, text or PAG (Portable Animated Graphics) file as GFX elements.

1. Tap  to open the GFX list.
2. Tap  to open the **Create New GFX** interface.
3. Choose **Custom** and then select a source type to add.
4. Tap  to add more sources.
  5. Tap the background button to change the background, aiding in positioning the GFX.
    -  : Transparent.
    -  : Program scene with active GFX (if any).
    -  : Gridlines.
6. Edit the GFX. See [editing tools](#) for details.
7. (Optional) Set timing, which makes the GFX disappearing automatically.
  - a. Tap  on the left.
  - b. Toggle on Timing.
  - c. Scroll time options to set the duration.
  - d. Tap Confirm.
8. Tap **Save**, and the GFX thumbnail appears in the GFX list.

You can add a total of three animated GFXs, including animated title, animated lower third and PAG.

Video GFX may reduce system performance.

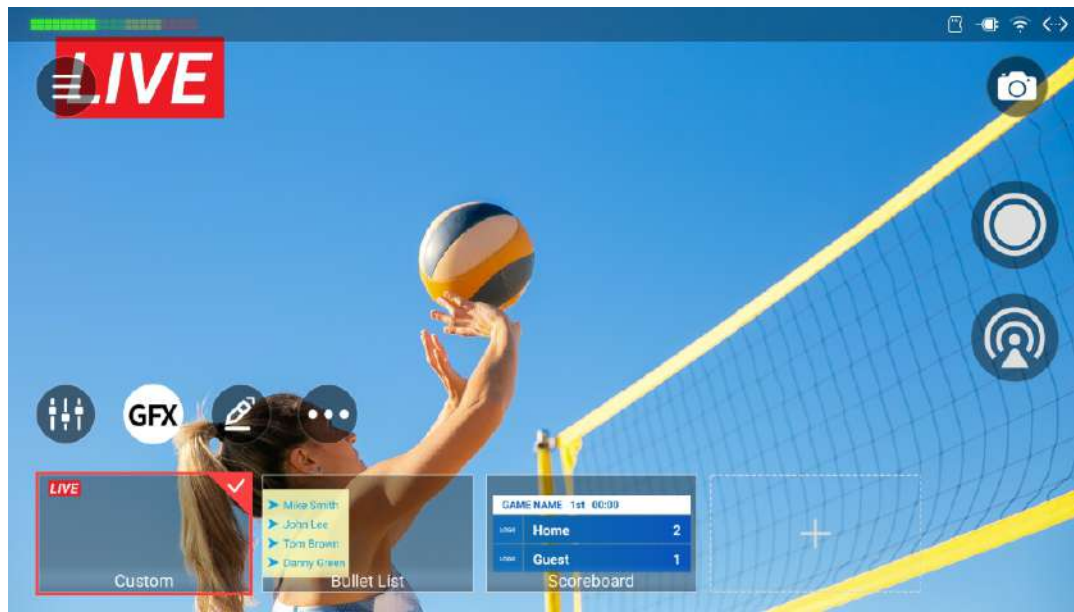

## Apply GFX

You can apply up to 8 GFXs in a show at the same time.

1. Tap  to open the GFX list.
2. Tap one GFX thumbnail, and then the GFX is displayed in the scene. A ✓ appears on the selected thumbnail.
3. If a bullet list is applied, and it is set as manual play mode, you can tap the text content on the screen to display the next line. (Only working in the program scene)
4. To cancel, tap one selected thumbnail, the GFX disappears.

If you select or unselect a GFX in the preview scene, your choice only takes effect after you switch the preview to program. If you do not tap the Switch button but tap the program scene again, your choice will be discarded.

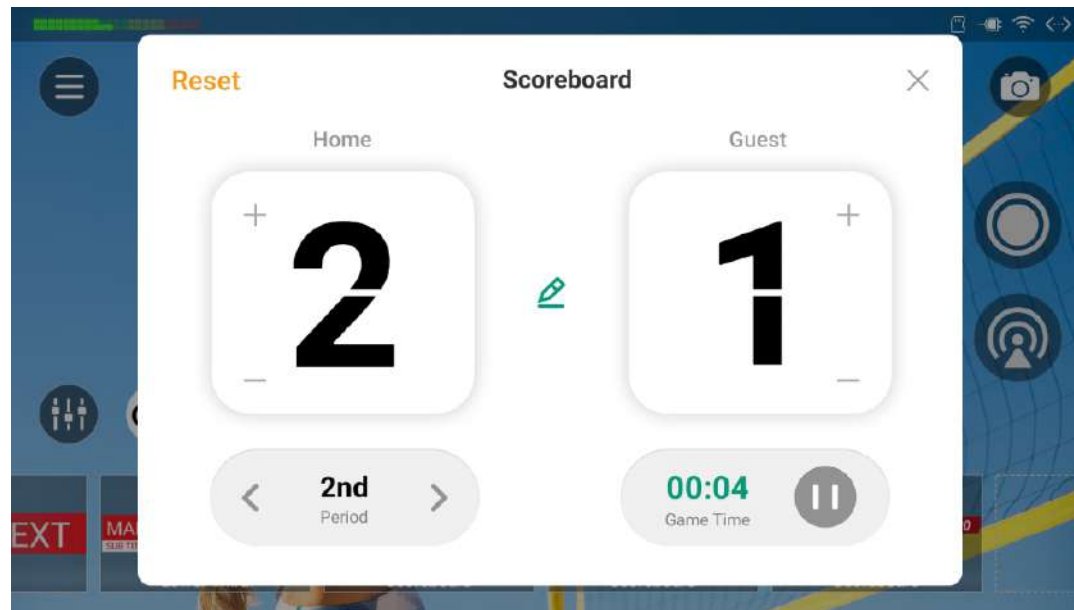

For the time counting related policies of some GFXs, including the policies of timer and stopwatch, and the timing of a custom GFX,

- In the program scene, when the GFX is selected, policies execute normally.
- In the preview scene, when the GFX is selected, policies do not execute; only when you switch the preview to program, policies start executing.
- If a GFX is applied in the program scene, in the preview scene, policies will go on executing.





## Control Scoreboard

You can only apply one scoreboard, but you can control all the scoreboards.



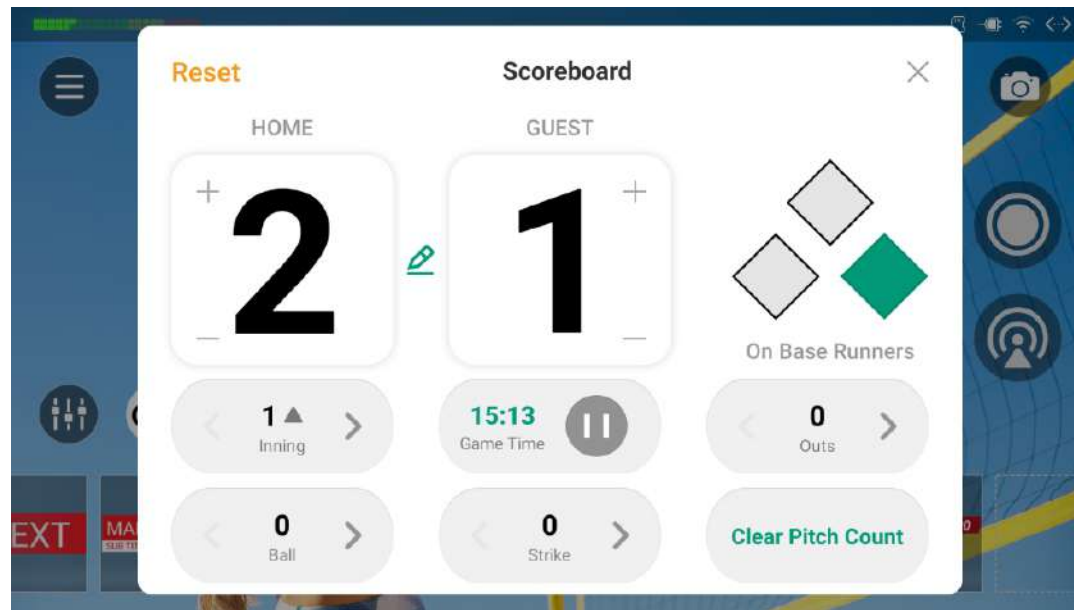

- Way 1: Tap  to control the displayed scoreboard.
- Way 2: Tap  to open the GFX list, long-press a scoreboard thumbnail and tap **Control** on the popup. By this way, you can control each scoreboard separately.
- Way 3: For a private scoreboard in a scene, long-press the scene thumbnail, and then tap the scoreboard control option on the popup menu.

## Control General Scoreboard

- Adjust score: Tap the upper part of the number to increase the score, and tap the lower part of the number to decrease the score.  
You can also tap , then scroll the score number of the home or guest team, and save your choice.
- Select period: Tap the left or right arrow at the bottom left to select a period. If the period is not set to be shown, you can tap "Show" to display it.
- Control game time:
  - Tap  at the bottom right to start counting; tap  to pause counting.
  - If the game time is not set to be shown, you can tap "Show" to display it.
  - Tap the time number, and scroll time options to adjust, or tap "Reset" to reset the game time to zero or the preset duration.
- Reset: Tap "Reset" to restore the score to 0:0, reset the game time to zero or reset to the preset duration.







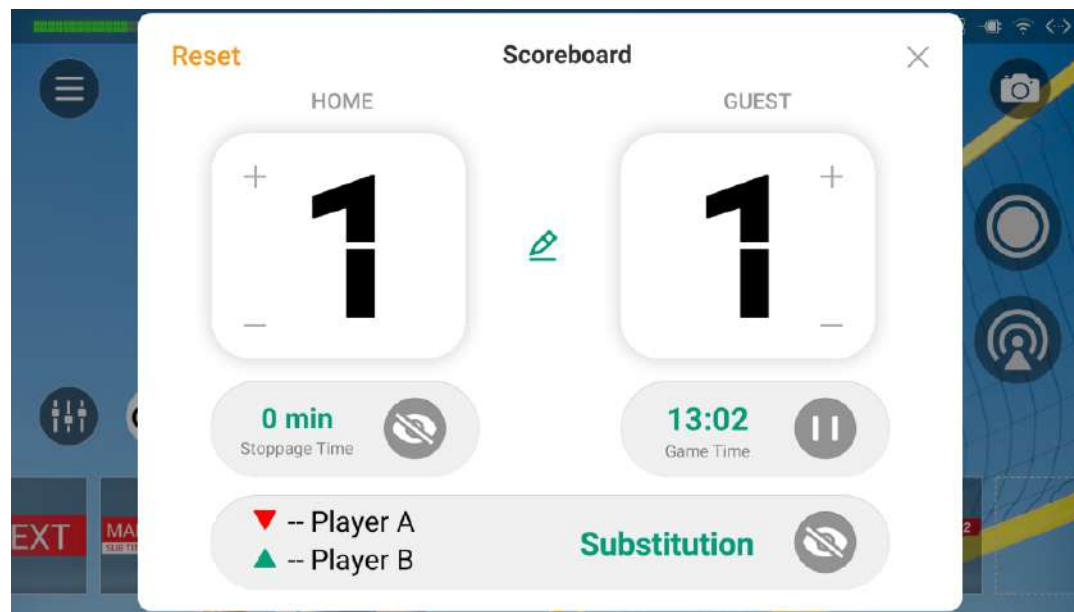

## Control Baseball Scoreboard

- Tap the upper part of the number to increase the score, and tap the lower part of the number to decrease the score.  
You can also tap , then scroll the score number of the home or guest team, and save your choice.
- Tap  to indicate runners on 1st Base, 2nd Base, and 3rd Base.
- Tap the left or right arrow of **Inning** to set inning number and its "top" or "bottom" half. And confirm whether to also clear settings of on-base runners, outs, balls and strikes on the popup.
- Control game time:
  - Tap  to start counting; tap  to pause counting.
  - Tap the time number, and then select time in the time box to adjust time, or tap "Reset" to reset the game time to zero or the preset duration.
- Tap the left or right arrow of **Out** to indicate outs as numbers or shapes.
- Tap the left or right arrow of **Ball** to indicate balls as numbers.
- Tap the left or right arrow of **Strike** to indicate strikes as numbers.
- Tap **Clear Pitch Count** to make balls and strikes both zero.
- Tap **Reset** to clean all the sets.

If some element is set to be hidden, you can tap "Show" to display it.



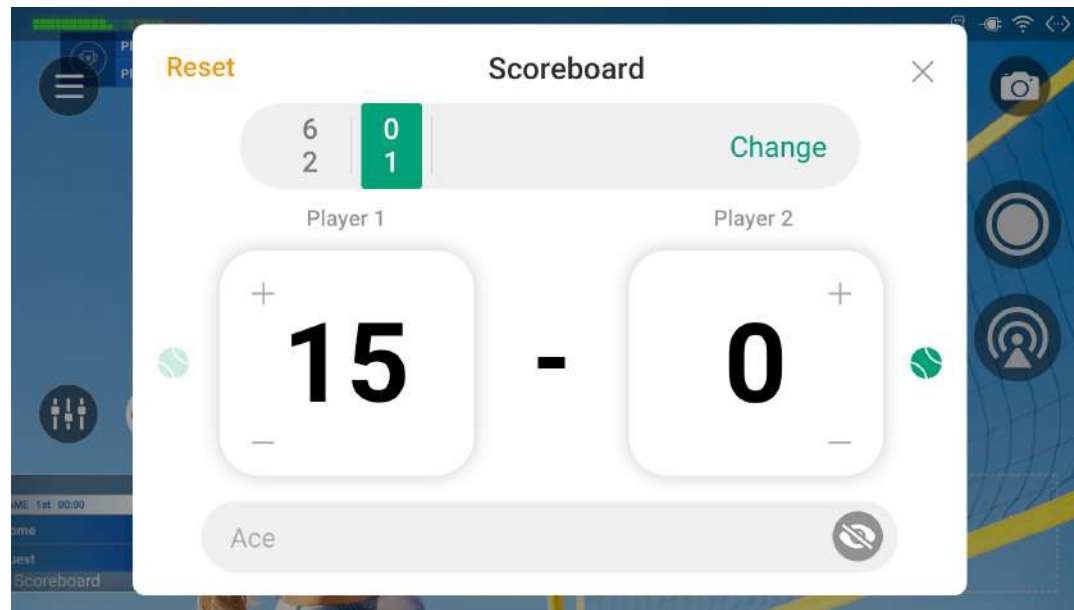

## Control Soccer Scoreboard

- Adjust score: Tap the upper part of the number to increase the score, and tap the lower part of the number to decrease the score. You can also tap , then scroll the score number of the home or guest team, and save your choice.
- Show stoppage time:
  - Tap the time number to select the stoppage time, and you can tap "Reset" to reset the stoppage time to zero.
  - Tap  to show the stoppage time, and tap  to hide.
- Control game time:
  - Tap  at the bottom right to start counting; tap  to pause counting.
  - Tap the time number, and scroll time options to adjust, or tap "Reset" to reset the game time to zero.
  - If the game time is not set to be shown, you can tap "Show" to display it.
- Show substitution:
  - Tap "Substitution" to enter the information of the players to enter and leave the field.
  - Tap  to show the substitution, and tap  to hide.
- Reset: Tap "Reset" to restore the score to 0:0, and reset the game time and stoppage time to zero.



## Control Tennis Scoreboard

- Adjust score: Tap the upper part of the score number to increase, and tap the lower part to decrease.
- Change server: According to the score, it automatically changes server. You can also tap  to change server.
- Adjust sets: Tap "Change" and then set game score for each set. You can also tap "Reset" on the popup to restore all the sets.
- Show message:
  - Tap the message box to enter or select a message.
  - Tap  to show the message, and tap  to hide.
- Reset: Tap "Reset" to restore the score to 0.

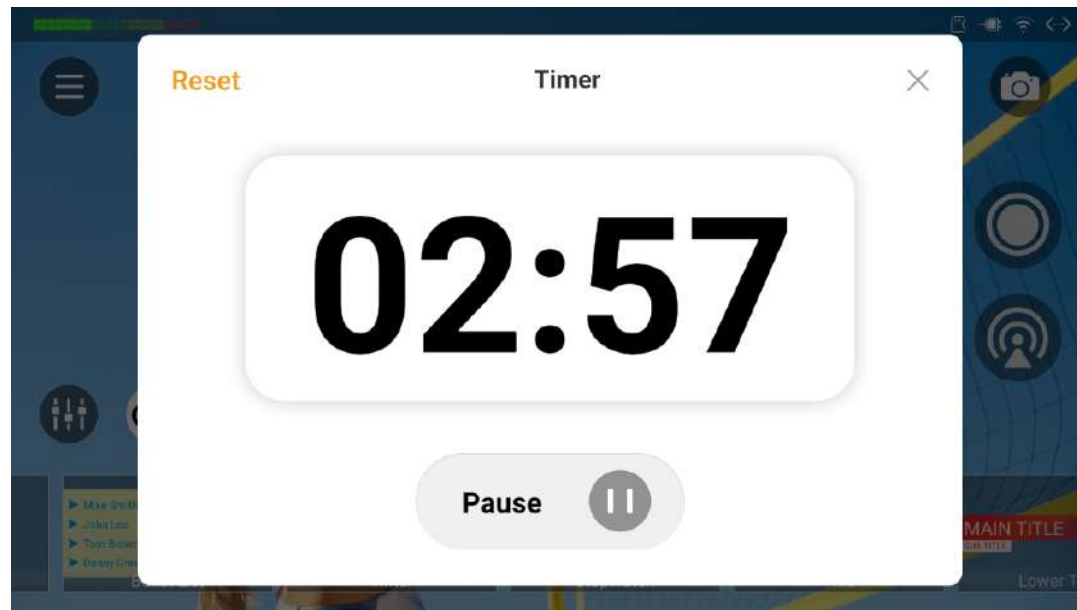



## Control Timer

You can apply only one timer, but you can control all the timers.

Way 1: When a timer is applied, tap  to control the displayed one.

Way 2: Tap  to open the GFX list, long-press a timer thumbnail and tap **Control** on the popup. By this way, you can control each timer separately.

Way 3: For a private timer in scene, long-press the scene thumbnail, and then tap the timer control option on the popup menu.

- Adjust duration: scroll hour, minute or second options to reset duration.
- Control counting: Tap  to start counting, tap  to pause counting, tap  again to resume counting.
- Reset: Tap **Reset** to restore the timer to the set duration, and you can re-select the duration.
- Tap "x" to return to the main screen.

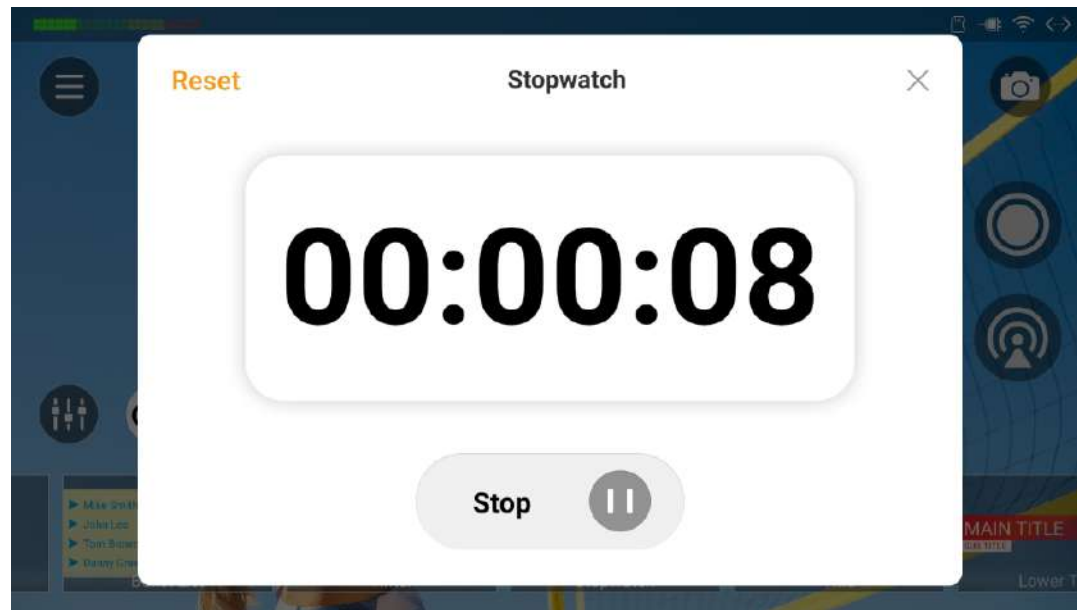



## Control Stopwatch

You can only apply one stopwatch, and but you can control all the stopwatches.

Way 1: When a stopwatch is applied, tap  to control the displayed one.

Way 2: Tap  to open the GFX list, long-press a stopwatch thumbnail and tap **Control** on the popup. By this way, you can control each stopwatch separately.

Way 3: For a private stopwatch in scene, long-press the scene thumbnail, and then tap the stopwatch control option on the popup menu.

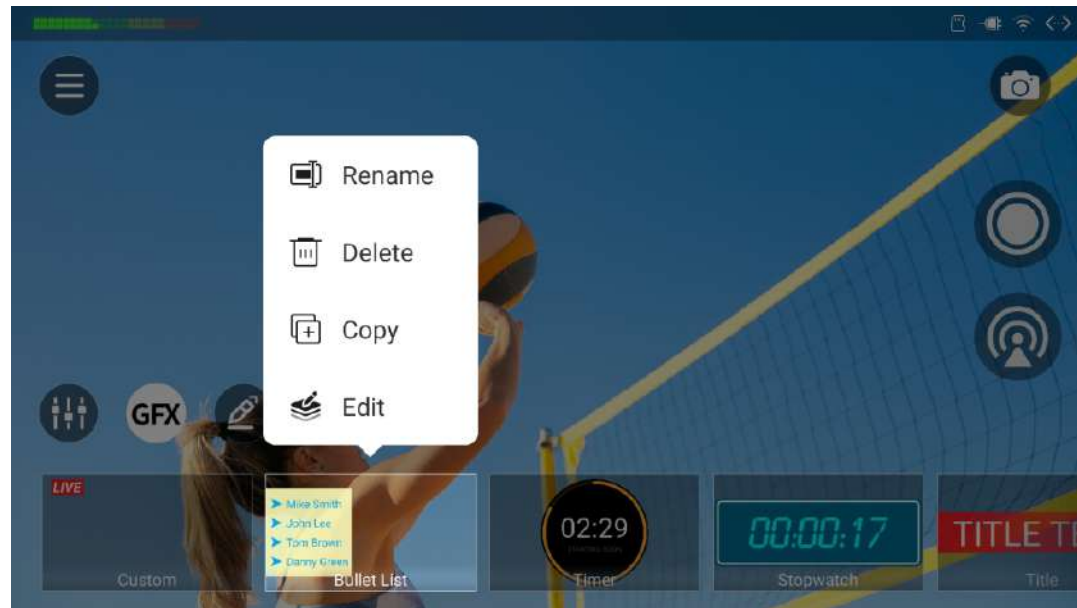

- Control counting: Tap  to start counting, tap  to pause counting, tap  again to resume counting.
- Reset: Tap **Reset** to reset the timer to zero.
- Tap "x" to return to the main screen.



## Manage GFX

### Rename GFX

Each GFX is named as the GFX type by default. You can rename the GFX.

1. Tap  to open the GFX list.
2. Long-press one GFX thumbnail.
3. Tap **Rename**, enter the new name and tap .

### Edit GFX



You can edit the existing GFX.

1. Tap  to open the GFX list.
2. Long-press one GFX thumbnail.
3. Tap **Edit** to open the editor and then start to edit.



### Copy GFX



You can copy an existing GFX to create a new GFX by the following ways.

Method 1:

1. Tap  to open the GFX list.
2. Long-press one GFX thumbnail.
3. Tap **Copy**.
4. Enter a new name and tap .

Method 2:

1. Tap  to open the GFX list.
2. Tap .
3. Select **Rearrange/Size** on the popup menu.

4. Tap  on the thumbnail of the GFX you want to copy.
5. Enter a new name and tap .
6. Tap **Done** at the upper right corner to go back to the main screen.



### Delete GFX

You can delete a GFX through the following ways.

#### Method 1

1. Tap  to open the GFX list.
2. Long-press one GFX thumbnail.
3. Tap **Delete**, and then confirm to delete in the popup.



#### Method 2

1. Tap  to open the GFX list.
2. Tap .
3. Select **Rearrange/Size** on the popup menu.
4. Tap the  button on a thumbnail, and then tap **Delete**.
5. Tap **Done** at the upper right corner.

### Re-order GFX





You can rearrange GFX order by long-pressing a thumbnail and then drag it to a desired position in the GFX list.

Besides, here is another method to rearrange GFX order.

1. Tap  to open the GFX list.
2. Tap .
3. Select **Rearrange/Size** on the popup menu.

4. Long press a thumbnail and then drag it to a desired position in the scene list.
5. Tap **Done** at the upper right corner.





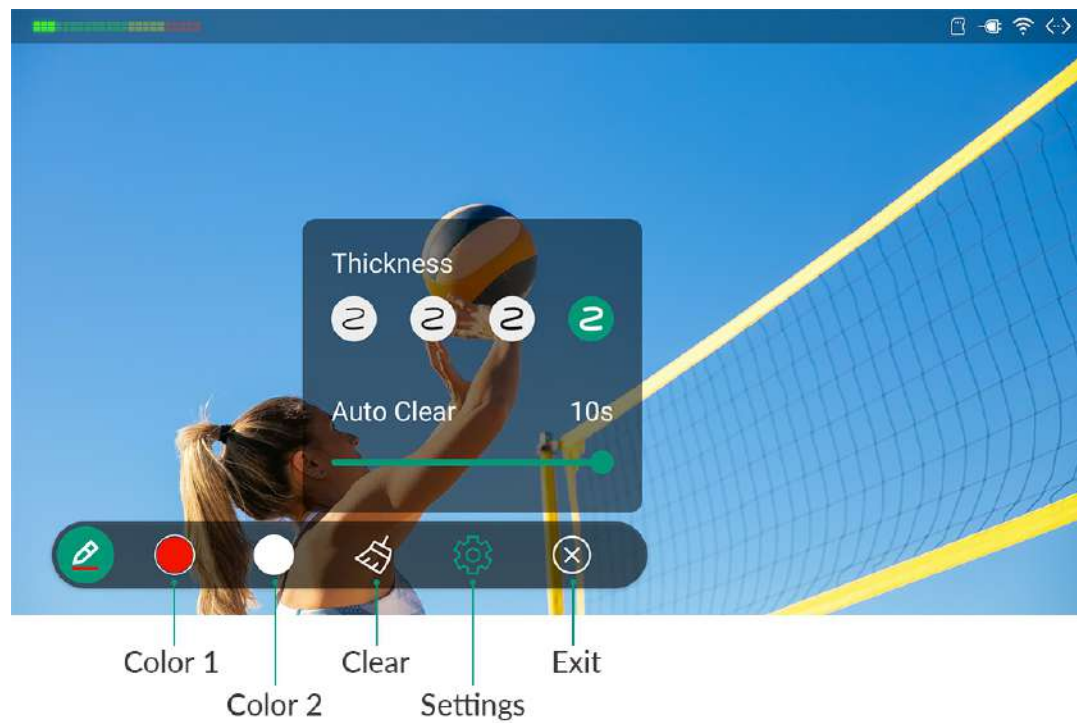

### Zoom GFX List

1. Tap  to open the GFX list.
2. Tap  on the main screen.
3. Select **Rearrange/Size** on the popup menu.
4. Tap  or  button on the right to change the size of thumbnails. It supports three sizes: small, middle and large. By default, the GFX list uses middle thumbnails.
5. Tap **Done** at the upper right corner.



## Use Pen

Director device provides the **Pen** to annotate on your show.

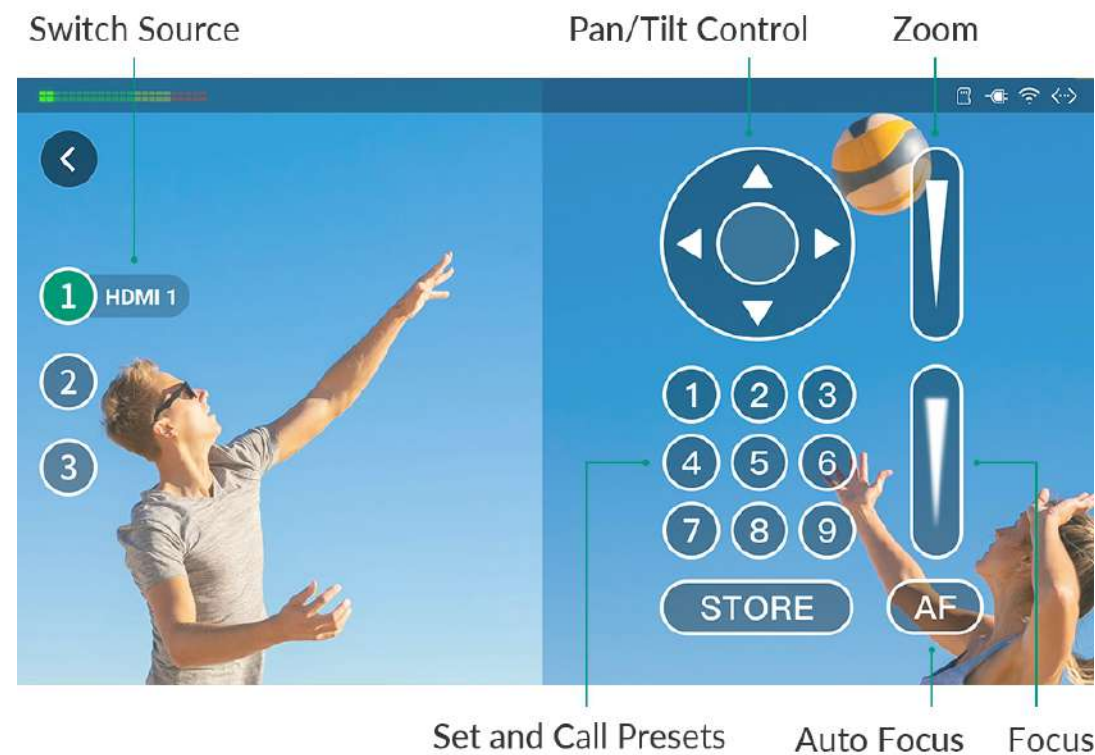

1. Tap  to enter the annotation mode.
2. Draw or write on the screen to annotate.
3. Tap  to expand the toolbar. To collapse, tap  again.
  - Tap **Color 1** or **Color 2** to switch the pen color, and tap **Color 1** or **Color 2** again to set color for each.
  - Tap  to clear the annotations.
  - Tap  for more advanced settings.
    - Select the pen thickness.
    - Drag the slider of **Auto Clear** to define the time for each annotation to remain on the screen. The default time is 5 seconds. The range is 0-10s. 0 indicates that the annotation will not disappear unless you manually clear it.
  - Tap  to exit the annotation mode. When you exit, all the annotations will disappear.



## Control PTZ

When a source supports UDP-based or NDI-based PTZ function, you can control the PTZ camera.

You can enter the PTZ control mode through the following ways, by which you can also enter phone camera control mode.

- Tap , which only applies to the Program and Preview scenes.
- Long-press a scene thumbnail, and select **PTZ Control**.
- If there are multiple PTZ sources or phone camera sources in the scene, select a source on the popup. After that, you can tap the numbers on the left (at the bottom for portrait mode) to switch sources.
- Long-press any blank area on the PTZ control panel and drag it to the desired position.
- For a program or preview scene, tap X to exit the control mode.
- For other scene, tap  to cut back to the live program or preview.

### Pan/Tilt Control

- On the Pan/Tilt Control panel, tap the center of the circle and slide your finger across the screen to move the camera. The closer to the center of the circle, the slower the camera moves; The farther away from the center of the circle, the faster the camera moves.
- Long-press the arrows to pan/tilt the camera.

### Zoom

Slide on the slide bar at the upper right to zoom.

- Slide up, and the lens zooms in.
- Slide down, and the lens zooms out.

### Focus

Slide on the slide bar at the lower right to focus.

- Slide up, and then the lens focuses near and the nearby object gets clear.
- Slide down, and then the lens focuses far and the distant object gets clear.

You can also tap  for auto focus.

### Presets

A preset is a predefined image position which contains information of pan, tilt, zoom, etc. After the preset is configured, you can move the camera to your desired position quickly by calling the preset.

1. Move the camera to your desired position and adjust zoom and focus.
2. Tap  and then tap a number to save. For example, if you tap No.1, it will be saved as Preset 1.
3. Repeat the steps above to add more presets.
4. Tap a preset No. to call the preset.

It supports adding up to 9 presets.

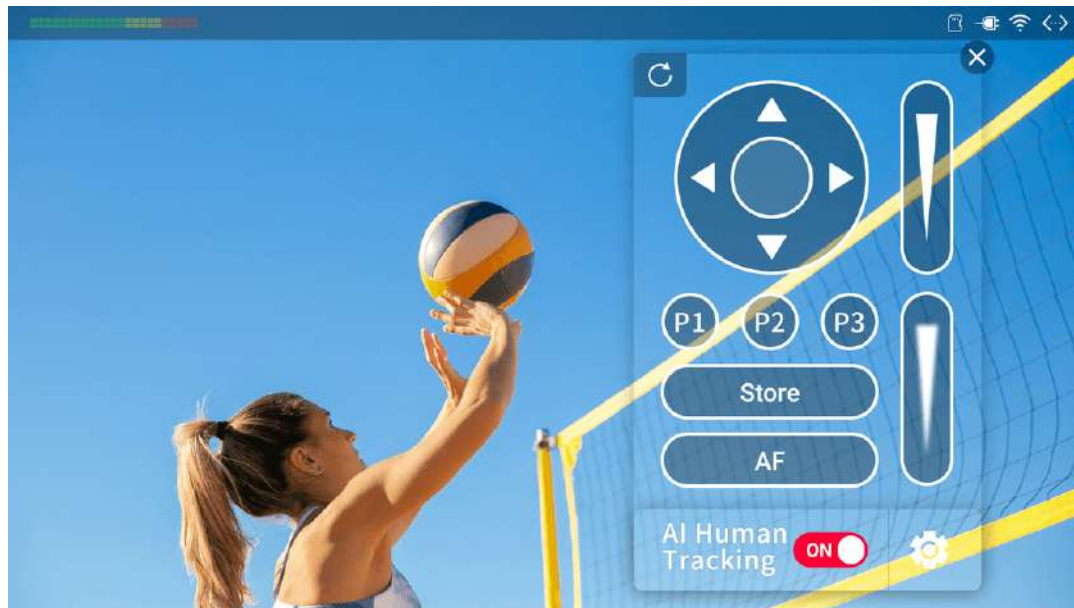

## Control OBSBOT WEBCAM

Director device is compatible with OBSBOT WEBCAMs. Besides basic controls including **Pan/Tilt Control**, **Zoom**, **Focus**, and **Presets**, the PTZ control panel for OBSBOT supports the following features.

For OBSBOT webcam, it supports adding up to 3 presets, and the preset numbers change to P1, P2 and P3.

### AI Human Tracking

1. Tap  to open the setting page.
2. Set tracking speed, mode, etc. Options may change with OBSBOT webcam modules.
3. Toggle on the switch of AI Human Tracking to start.
4. Toggle off the switch of AI Human Tracking to stop.

### Record

If your OBSBOT webcam supports recording, such as OBSBOT Tail Air, you can record videos to the SD card installed in the webcam.

- Tap **Record** to start recording.
- Tap **Recording** to stop.

### Reset

Tap  to reset the OBSBOT webcam to its initial position.



### Wake Up

If the OBSBOT webcam has gone to sleep, such as OBSBOT Tiny 2, tap **Wake Up** to bring it back to work.















## Control Phone Camera

When a scene contains a phone camera source, you can control phone camera on device.

- Enter phone camera control mode through the following ways, by which you can also enter the PTZ control mode.
  - Tap , which only applies to the Program and Preview scenes.
  - Long-press a scene thumbnail, and select **PTZ Control**.
  - If there are multiple PTZ sources or phone camera sources in the scene, select a source on the popup. After that, you can tap the numbers on the left (at the bottom for portrait mode) to switch sources.
- Tap  to view the image quality and control the phone camera:
  - Tap  and select **Front-facing** camera or **Back-facing** camera. There will be more back camera options, such as Back Dual Wide Camera and Back Ultra Wide Camera, depending on your phone type. Besides, you can even select a USB camera connected with your iPad.

To use the external USB webcams, the iPad requires an iPadOS version of 17 or above and it should have a USB-C port for connectivity.

- Tap  /  to enable or disable the microphone.
- Tap  /  to turn on/off the flashlight.
- Tap  /  to enable or disable image stabilization.
- Tap **Record** to record the phone camera image to your mobile device. Tap again to stop recording.

- Drag  to control the phone camera to zoom in or out.
3. Tap  to set White Balance:  
Select an appropriate white balance mode to ensure a true-to-life color range. For example, select  when shooting in bright daylight. You can also slide the value according to your preference.
  4. Tap  to set ISO:  
Slide the ISO value to set camera light sensitivity. Low values are for stationary or well-lit objects. Higher values are for fast-moving or low-lit objects, but which can result in noise.
  5. Tap  to adjust Focus:  
Drag the adjustment bar to manually adjust the focus.
  6. Tap  to adjust Exposure:  
Slide to change the exposure value. This determines how much light the camera's sensor receives. For low-light situations, use a higher exposure.
  7. Tap a place on the phone camera image to focus.
  8. Tap and hold on a part of the screen for a few seconds to enable AE/AF lock. A yellow box will appear on the phone screen, and the focus is locked on that part. It will remain locked until you tap on another part of the screen.
  9. For a program or preview scene, tap X to exit the control mode.
  10. For other scene, tap  to cut back to the live program or preview.

For some phones, they may not support the focus function due to their own limitation.

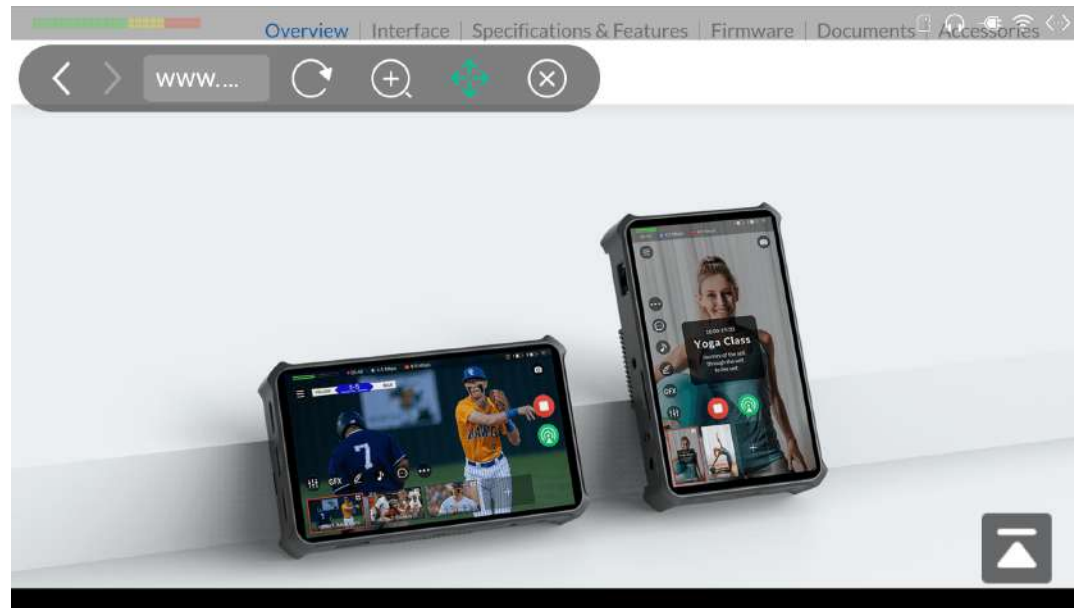

## Control Webpage

When a scene contains a webpage source, you can browse the webpage.

1. Long-press the scene thumbnail, and select **Webpage** on the popup menu to enter the webpage control mode.  
The webpage goes to full-screen mode, and a toolbar appears.
2. Slide on the screen to scroll the webpage.
3. Tap a hyperlink in the webpage to visit.
4. Tap a text input box in the webpage and type in text.
5. Tap **<** or **>** to go back or forward.
6. Tap the address bar, enter a URL and tap the Enter key to jump to a new webpage.
7. Tap **↻** to reload the webpage.
8. Tap **+** and then tap **+** or **-** to zoom in or out, and tap **Reset** to display the webpage at 100% magnification.
9. Tap **↕** and then drag and drop the toolbar to change its position.
10. Tap **✕** to go back to the main screen.

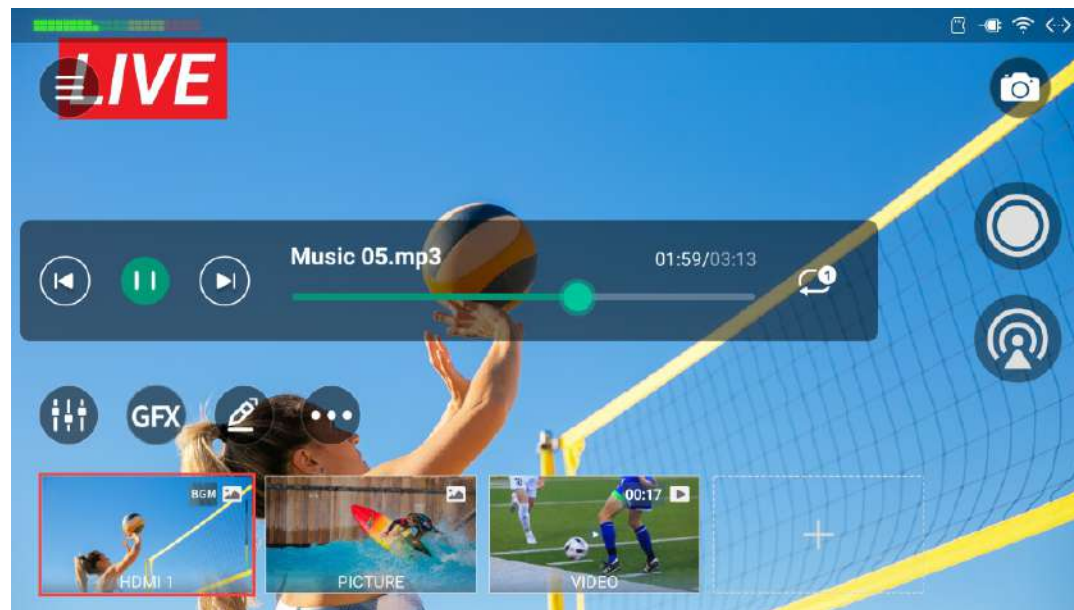

## Control BGM

You can control the playback of the background music.

1. Tap > to reveal the BGM playback bar.
2. Tap the buttons on the playback bar to control the BGM playback.
  - Tap to play or to pause.
  - Tap to play the previous song or to play the next song.
  - Drag the playhead to a specified position.
  - Set the loop policy:
    - : Repeat the playlist
    - : Repeat the song
    - : Shuffle the playlist

Tips for using global and private BGM:

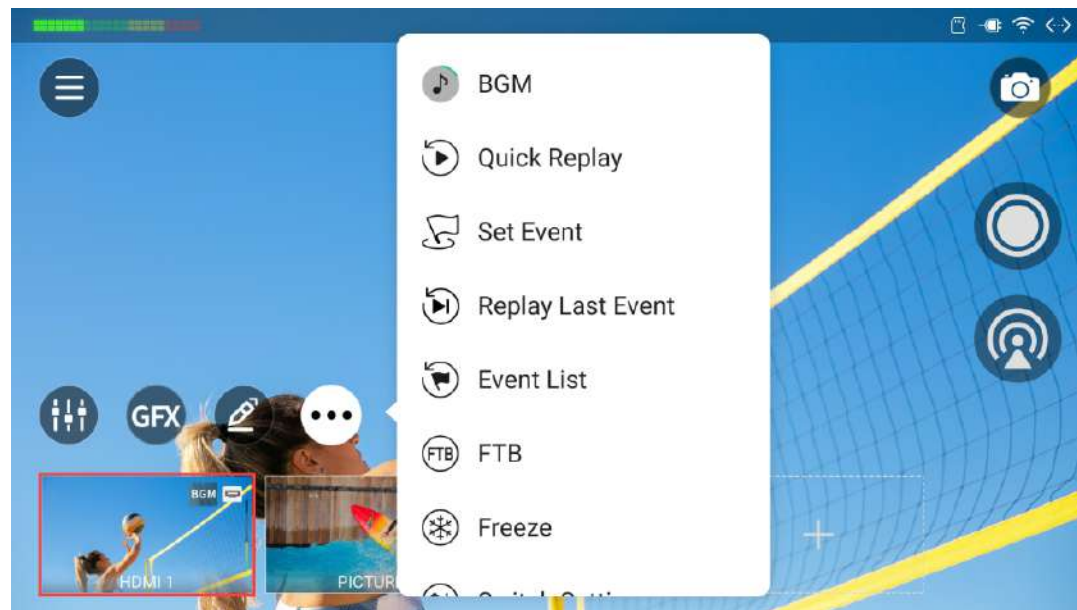

1. The global BGM needs to be started manually.
2. When you switch to a scene with private BGM, the global BGM will be paused. And the private BGM can be started manually or automatically, which can be set in the scene editor. When you switch to a scene without private BGM, the global BGM resumes to play.
3. If you have paused the global BGM manually, you need to resume it manually after you switch scenes.





## Replay

Replay allows you capture some of greatest moments, slow down the action and save your highlights. You can go to  > Settings > Replay to enable and set the function. Please refer to [Replay](#).

## Quick Replay



Tap  >  **Quick Replay** to review the recent live content.



- If you have set **Duration of quick replay** to a specific duration in  > "Settings" > "Replay", it will directly enter the replay mode.
- If you have set **Duration of quick replay** to "Ask me when replay starts" in  > "Settings" > "Replay", select the duration in the popup window, and then it enters the replay mode.
- If you have enabled two replay cameras, on the popup window, you can select a replay mode to decide the replay layout and order.

## Event Replay

You can also save events during live program, and replay the events later.

## Set Event

You can double tap on the main screen to set an event, or tap  >  **Set Event**.



- If you have set **Duration of event replay** to a specific duration in  > "Settings" > "Replay", it will directly save the event.
- If you have set **Duration of event replay** to "Ask me when setting" in  > "Settings" > "Replay", select the duration in the popup window, and then it save the event.

## Replay Last Event

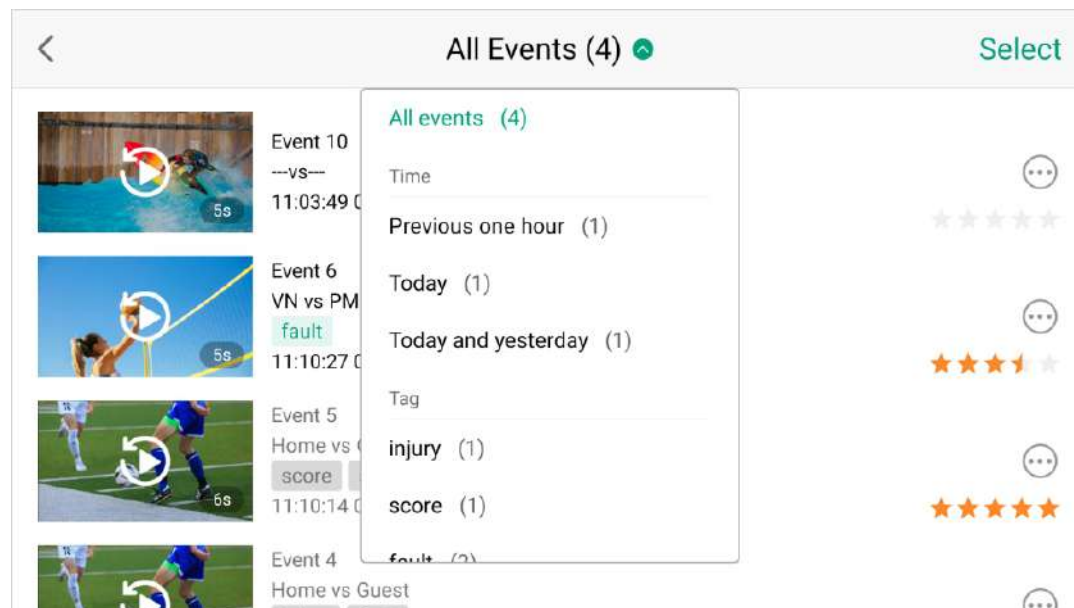
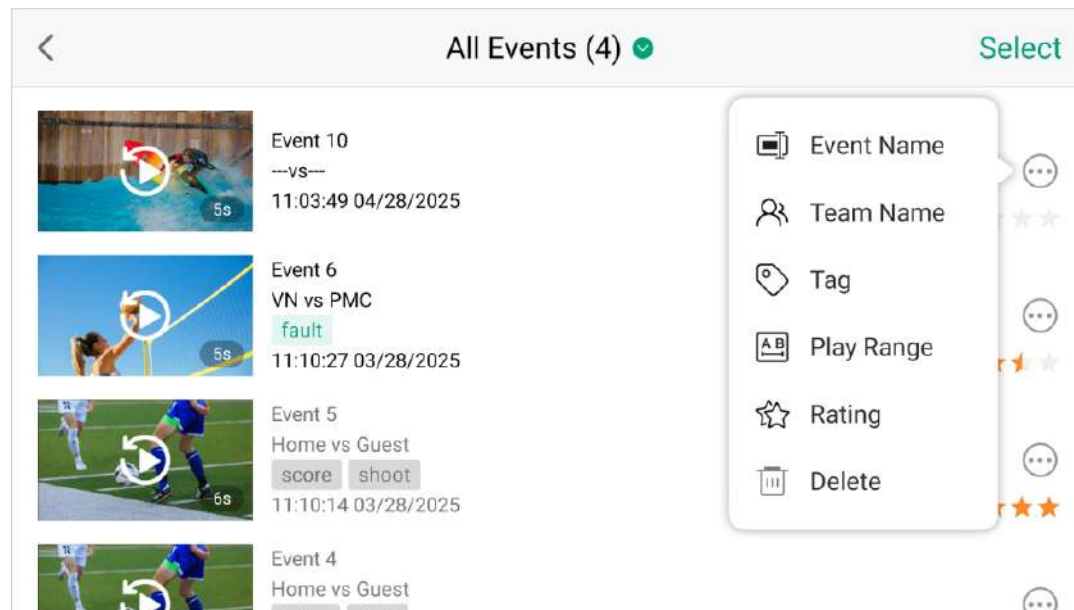
Tap  >  **Replay Last Event** to replay the last event.



## Manage and Replay Events

1. Tap  >  **Event List** to open the even list.
2. Tap  to configure the following items.
  - **Event Name:** Enter or change the name of an event for easy identification and management.
  - **Team Name:** Enter or change the names of teams related to the event, clarifying the participating parties.
  - **Tag:** Tap **Add Tag** to add descriptive tags, which help to quickly mark key information. Then, you can select up to three tags for each event.
  - **Play Range:** Drag the A or B slider to precisely set the start and end points of the event video to focus on important segments.
  - **Rating:** Rate the event with stars to intuitively reflect the importance or excitement level of the event.
  - **Delete:** Remove the unnecessary event and its associated information.
3. Tap the arrow icon on the title line to expand the filter page, and then tap one condition to filter events.
  - **All events:** It lists all the events.
  - **Time:** You can filter events of "Previous one hour", "Today", as well as "Today and yesterday".
  - **Tag:** You can filter events per different tag.

4. Replay single event:
  - i. Tap the event thumbnail to bring out the preview window.
  - ii. Tap the play button to preview the event.
  - iii. Tap the **Replay** button to start replaying this event.





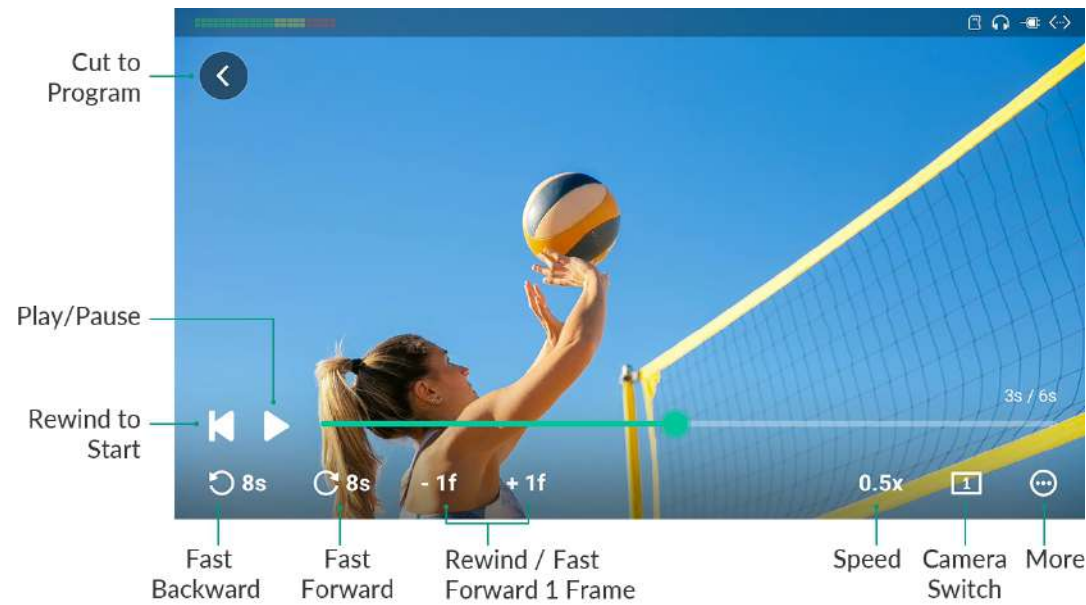

If you have enabled two replay cameras, on the popup window, you can select a replay mode to determine the replay layout and sequence.





5. Replay multiple events:
  - i. Tap **Select** at the upper right corner.
  - ii. Select events you needed, or tap **Select All**.
  - iii. Tap **Replay...** at the bottom.
  - iv. Select replay action.
    - **Loop replay:** If not enabled, it only replays once. If enabled, it replays repeatedly at the set time duration, and you can set the duration by tapping "Loop time".
    - **Replay order:** Select a order. Options include Oldest to Newest, Newest to Oldest and Order of Selection.
  - v. Tap **Replay** to start replaying all the selected events.
6. To delete multiple events, tap **Select** at the upper right corner, select the events you needed, or tap **Select All**, then tap **Delete** at the bottom.



## Control Replay

After entering the replay mode, you can perform the following operations.



- Drag the playhead of progress bar to adjust the progress.
- Tap  to rewind to the start.
- Tap  or  to play or pause the replay.
- Zoom in the image:
  - Double tap one position on the screen to zoom in the image to 2x.
  - Stretch with two fingers to zoom in. The maximum zoom range is 8x.
  - Drag the image to change the displayed area.
  - To exit, double tap the screen again or pinch with two fingers to zoom out to the original size.
- Tap  or  to fast backward or forward at a faster pace, such as 5s, which is set in [Replay](#).
- Tap **-1f** to rewind one frame, or tap **+1f** to fast forward one frame. And the replay will be paused at the same time.
- Tap the speed button to change the playback rate. Options include 0.1x, 0.25x, 0.33x, 0.5x (default), 0.75x, and 1.0x.
- Tap the camera switch button to switch the replay image.
  - **1**: Camera 1
  - **2**: Camera 2
  - **12**: Camera 1 and 2 in side-by-side layout
  - **21**: Camera 2 and 1 in side-by-side layout
- Tap  for more features.

- **Save event:** save the content of quick replay to the Album.
- **Start annotate:** tap to start annotating on the main screen.
  - Tap  to expand the toolbar, and refer to [Use Pen](#) for details.
  - When the image is zoomed in, tap  to switch to Move mode, and then you can move the image. Tap  to switch back to Annotation mode.
- **Mute/Unmute sound:** tap to mute or unmute the sound of replay.
- Tap blank area to hide the progress bar and buttons, and tap again to bring them back.
- Tap  to cut back to the live program.

## View Saved Events

To view saved events, please go to  > [Album](#) > Replay.

## Use Shortcuts

After you have created [shortcuts](#) in the settings page, you can tap  >  **Shortcuts** to call out the shortcut list page on the main screen. Then you can tap shortcuts to control your show.

# Start Streaming and Recording

Director device can stream to multiple platforms, and supports recording the show for later use. You can stream and record separately or simultaneously, and implement interactive operations to attract your audience.

## Live Streaming

You can stream to four platforms with different encoding formats at the same time. It natively supports streaming to YouTube, Twitch, and Facebook live, and also supports streaming via [RTMP](#), [SRT](#) or [RTSP](#). Besides, it supports two-channel NDI<sup>®</sup> HX3 streaming.

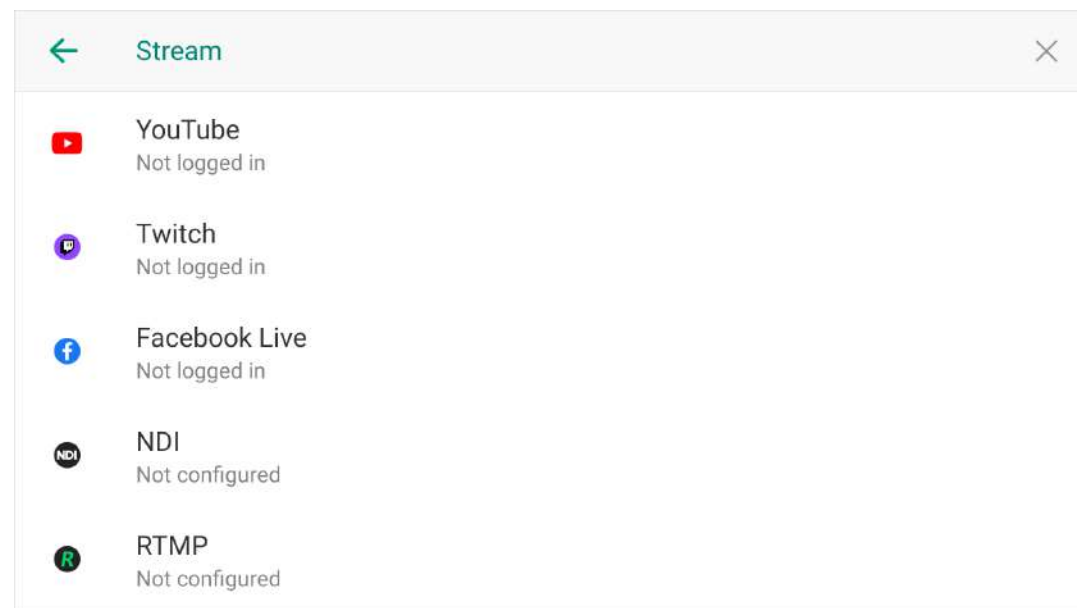



## Configure Streaming Server

Before streaming your show, you need to configure the destinations you want to stream to.

To configure a server, please tap  > **Settings** > **Stream** to open the stream setting page, and then select a server.

Then follow the steps below to configure the streaming server.

 If no Quick Stream is enabled for any server, you can also tap  on the main screen and then select a server to enter its configuration page.

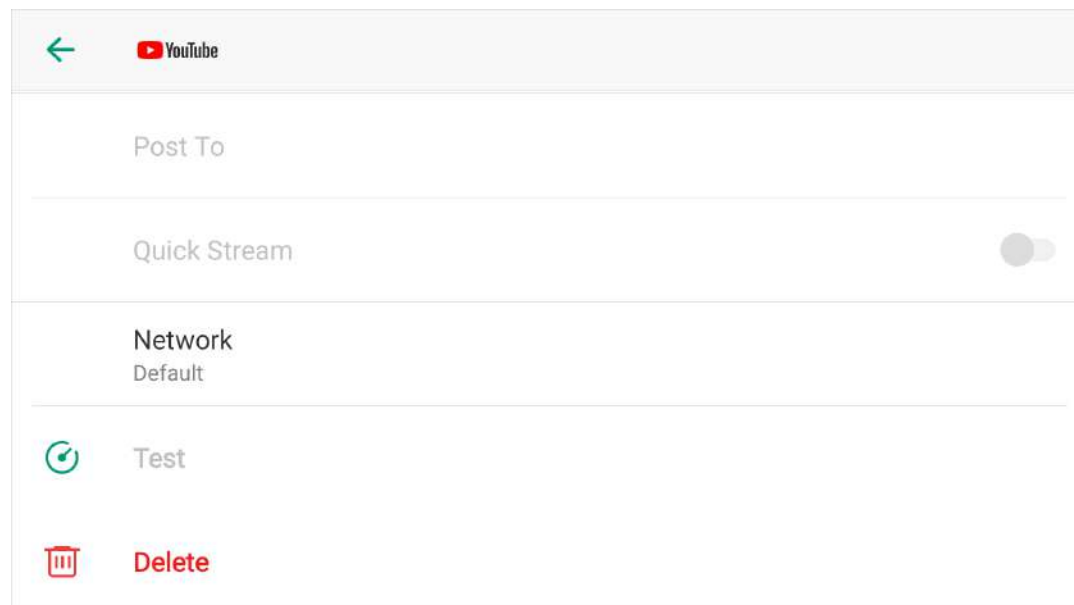
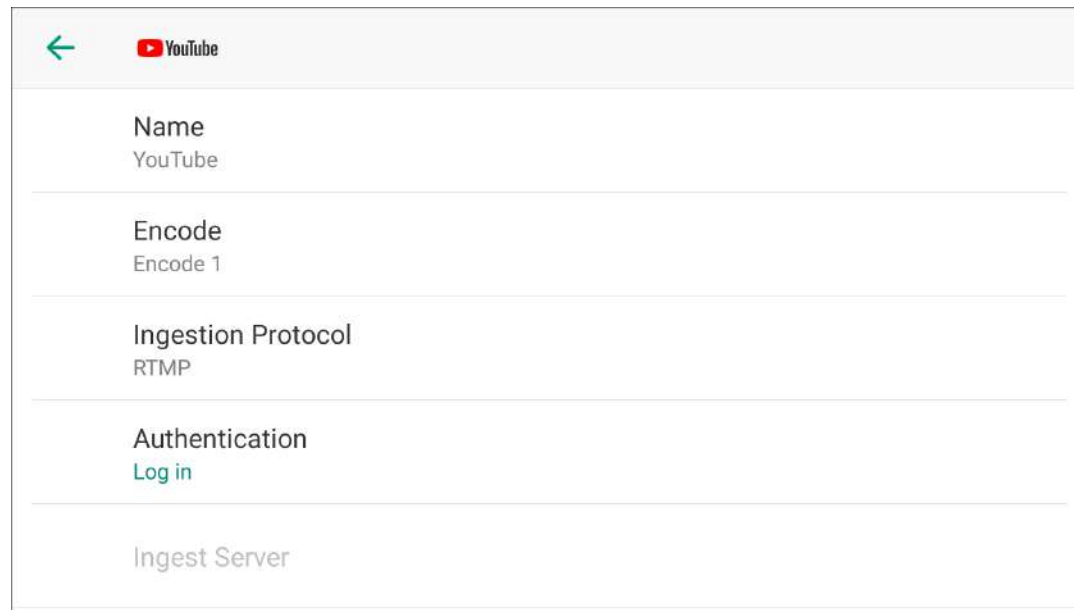

## Configure YouTube Server

1. Select **YouTUBE** in the stream setting page.
2. Tap **Name** to enter an alias name for your convenience of multi-item management.
3. Tap **Encode**, and select a stream scheme.

You can customize encode parameters and sources as needed. For details, please refer to [Encode](#).

4. Tap **Ingestion Protocol** to select **RTMP** or **HLS**.
5. Tap **Log In** under **Authentication**, and then follow the instructions to log into your account.

Your username and profile image will be displayed after login.

Your nickname, user avatar images and authorization token will be stored encrypted in Director device after a successful authorization. When you [delete the YouTube server](#) or remove Director device from trusted apps from your [Google account's security setting](#), we will follow the policies of Google to clear saved data in 0 to 24 hours.

If you have not enabled live streaming for your YouTube account, your YouTube login will fail. Also note that you need to have live streaming enabled 24 hours before starting streaming. For details, see [Why can't I log in to my YouTube account](#).

6. Set the **Ingest Server**.  
You can select **Primary server (rtmp)**, **Primary server (rtmps)**, **Backup server (rtmp)**, or **Backup server (rtmps)**.
7. Tap **Post to**, and select a channel, event, or **New stream**.

If you select **New stream**, you need to set **Title** (mandatory), **Description**, and **Privacy**.

- **Privacy** options are:
  - **Public**: The stream is visible to all people.
  - **Private**: The stream is visible only to you and people selected by you.
  - **Unlisted**: The stream is visible only through a link.
- 8. (Optional) Tap on **Quick Stream**. When it is enabled, you can start streaming quickly on the main screen.
- 9. Tap **Network** to set the network priority for streaming. Options include:
  - **Default**: The system's default network priority, that is Ethernet > WLAN > Cellular.
  - **Cellular First**
  - **WLAN First**
  - **Ethernet First**
- 10. Tap **Test** to test whether the previous configurations are working properly.

If you create a new stream to post to, it enables Auto-start by default. When you start streaming to this channel, you can edit the title and description, and then it goes live at once on YouTube. If you need to preview the stream at first, you may refer to [How to start a stream scheduled later for YouTube](#).

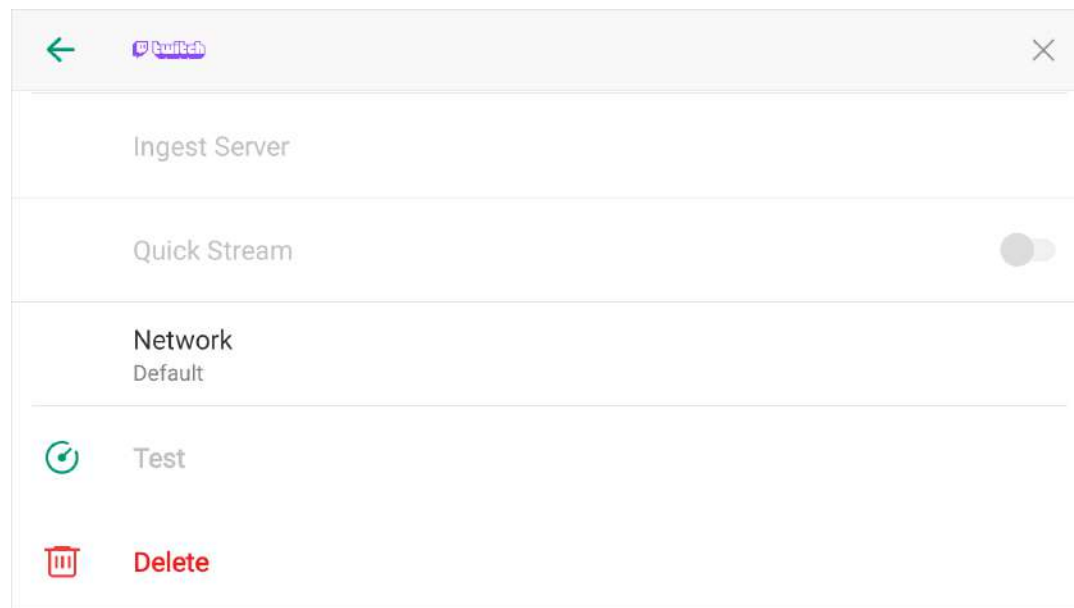
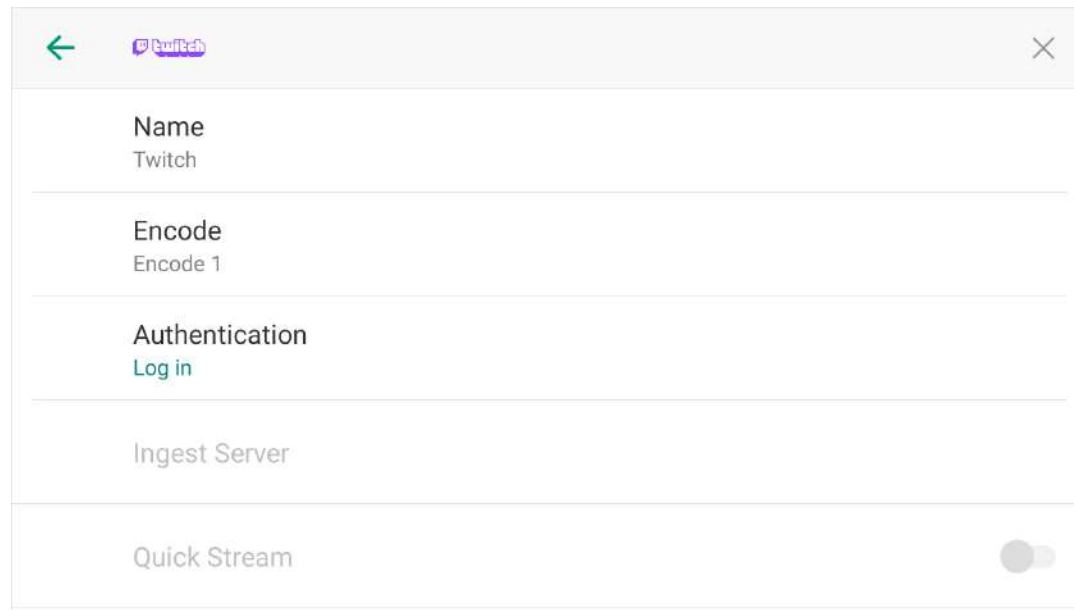

## Configure Twitch Server

1. Select **Twitch** in the stream setting page.
2. Tap **Name** to enter an alias name for your convenience of multi-item management.
3. Tap **Encode**, and select a stream scheme.

You can customize encode parameters and sources as needed. For details, please refer to [Encode](#).

4. Tap **Log In** under **Authentication**, and then follow the instructions to log into your account.
5. Set the **Ingest Server**.  
The system lists available servers. You can select a nearby server for an optimal network path.
6. (Optional) Toggle on **Quick Stream**. When it is enabled, you can start streaming quickly on the main screen.
7. Tap **Network** to set the network priority for streaming. Options include:
  - Default: The system's default network priority, that is Ethernet > WLAN > Cellular.
  - Cellular First
  - WLAN First
  - Ethernet First
8. Tap **Test** to test whether the previous configurations are working properly.

← **f LIVE**

**Name**  
Facebook Live

**Encode**  
Encode 1

**Authentication**  
[Log in](#)

**Ingest Server**

**Post To**

← **f LIVE** ×

**Title**

**Description**

**Audience**  
Public

**Quick Stream**

**Network**  
Default

## Configure Facebook Live Server

1. Select **Facebook** in the stream setting page.
2. Tap **Name** to enter an alias name for your convenience of multi-item management.
3. Tap **Encode**, and select a stream scheme.

You can customize encode parameters and sources as needed. For details, please refer to [Encode](#).

4. Tap **Log In** under **Authentication**, and then follow the instructions to log into your account.  
Your username and profile image will be displayed after login.  
Your nickname, user avatar images and authorization token will be stored encrypted in Director device after a successful authorization. To delete your information, you can [delete the created server](#) or you can remove Director device from trusted apps from [Facebook](#). Your personal data will be deleted upon request in 0 to 24 hours.  
After you log in successfully, the system automatically selects a ingest server for you, which you cannot change.
5. Tap **Post to** to access the list of Timeline and Page, and then select Timeline or a Page as the streaming destination.
6. (Optional) Set **Title** and **Description**.

**Title** supports a maximum of 255 bytes.

7. Tap **Audience** to select who can see your live content. Options include Public, Friends and Only me.
8. (Optional) Toggle on **Quick Stream**. When it is enabled, you can start

streaming quickly on the main screen.

9. Tap **Network** to set the network priority for streaming. Options include:
  - Default: The system's default network priority, that is Ethernet > WLAN > Cellular.
  - Cellular First
  - WLAN First
  - Ethernet First
10. Tap **Test** to test whether the previous configurations are working properly.

← NDI

Alias  
NDI

Source Name

Group Name  
public

Encoding Source  
Program

Program Stream  
H.264, 1080p, 60 fps, 62.0 Mbps

← NDI

Preview Stream  
360p, 30 fps, 3.0 Mbps

Transport Mode  
TCP (Uni-connection)

Discovery Server

Failover

 Test

## Configure NDI® Server

1. Select **NDI®** in the stream setting page.
2. Tap **Alias** to enter an alias name for your convenience of multi-item management.
3. Tap **Source Name** to enter a name, which is the name of the output NDI® stream for the receiver to recognize. It supports 1-30 characters, which contain A-Z, a-z, 0-9 and \_-#()%.
4. Tap **Group Name** to enter a name to specify the client group receiving the NDI® stream. It supports 1-64 characters, contain A-Z, a-z, 0-9 and \_-.,. Multiple group names can be comma-separated. The default group name is public. If you do not want other devices on the network to be able to search for it at will, you can set a private group name, and other devices need to use the private group name to search for this device.
5. Tap **Video Source** to select the video source to encode. Options include Program, HDMI 1, HDMI 2, Webcam 1, Webcam 2 and Multi-View.
6. Tap **Audio Source** to select the audio source to encode. Options include Program, HDMI 1, HDMI 2, MIC, available USB MIC, and None.
7. Tap **Program Stream** to set the following parameters.
  - **Codec:** Options include H.264 and H.265.
  - **Resolution:** Options include 640x360, 960x540, 1280x720, 1920x1080.
  - **FPS:** Options change along with the frame rate of the show, which can be 60/59.94/50/30/29.97/25/24/23.98/15 fps.
  - **Bitrate:** It automatically changes according to resolution and FPS options.

- **Profile:** Options include Baseline Profile, Main Profile, High Profile.
  - **Bitrate Mode:** It is fixed at **CBR**.
8. Tap **Preview Stream** to set the following parameters.
- **Resolution:** It is fixed at 640x360.
  - **FPS:** It changes along with the frame rate of the show.
  - **Bitrate:** It automatically changes according to the settings of Program Stream.
  - **Profile:** Options include Baseline Profile, Main Profile, High Profile.
  - **Bitrate Mode:** It is fixed at **CBR**.
9. Tap **Transport Mode**, select a mode and set parameters if needed.
- **UDP (Unicast):** The device sends a UDP stream directly to the receiver. It is used where lower latency matters. And multiple simultaneous streams will work independently for multiple receivers.
  - **UDP (Multicast):** The device sends the UDP stream to a multicast group. It is used for one-to-many broadcast for lower CPU usage. Parameters in a multicast configuration include:
    - **Multicast IP:** IP ranges from 224.0.0.0 to 239.255.255.255.
    - **Subnet Mask:** The legitimate value ranges from 255.0.0.0 to 255.255.255.252.
    - **Time to live:** It ranges from 1 to 255. The default value is 4.
  - **RUDP (Unicast):** Reliable User Datagram Protocol, is a connection-oriented and unicast protocol. RUDP helps to maintain the flow control and reliability of data transfer. The transmission control algorithms on both sending and receiving sides guarantee the RUDP

capable of recovering from data loss, duplication, delay and reordering.

- **TCP (Uni-Connection):** It indicates to establish single TCP connection between the device and the receiver, and transfer all A/V packets via one port. Compared with UDP (Unicast) or TCP (Multi-Connection), it has lower CPU usage. It is used where reliable data transfer matters, which makes it suitable for 4K NDI streams.
- **TCP (Multi-Connection):** It indicates to establish multiple TCP connections between the device and receivers, but transfer audio packet and video packet via different ports. It usually works in a complicated networking studio. It is used where reliable transmission of data matters, which makes it suitable for 4K NDI streams.

10. (Optional) Toggle on **Discovery Server**, and then the device can only be received by the specified receiver, and the mDNS auto-discovery function is unavailable.
  - i. Ensure that the receiver and device can ping each other.  
This function works between device and receiver that can ping each other even from differential network segment. After setting, the output stream of your device can be received by specified server.
  - ii. Specify the **Server IP** to the IP address of the discovery server.
  - iii. Launch the **NDI Access Manager** tool installed in the reception computer, enter the **Advanced** tab, uncheck **Multicast Sending Enabled**, and check **Use Discovery Server**, and then specify **Server IP** to the IP address of the receiver server running discovery service function.  
Note: The Server IP of NDI Access Manager and Director device should be the same.

11. (Optional) Toggle on **Failover** to protect your NDI transmission from

failure. If the source video fails, the backup device begins to provide a service. The initial source will be restored after it recovers.

- **Source name** shows the backup NDI channel name.  
Tap **Change** and select the failover (backup) video device within the same NDI group as the initial source.
- **IP address** shows the IP Address of the backup NDI channel, which is automatically obtained after you select the backup NDI source.

12. Tap **Test** to test whether the previous configurations are working properly.

← **RTMP**

Name  
RTMP Server

Encode  
Encode 1

URL

Stream Key

Authentication

← **RTMP**

Authentication

Quick Stream

Network  
Default

**Test**

**Delete**

## Configure **RTMP** Server

1. Select **RTMP** in the stream setting page.
2. Tap **Name** to enter an alias name for your convenience of multi-item management.
3. Tap **Encode**, and select a stream scheme.

You can customize encode parameters and sources as needed. For details, please refer to [Encode](#).

4. Tap **URL**, and enter the URL of the stream destination. It supports **RTMP** and RTMPS.
5. Tap **Stream Key**, and enter the key got from the stream destination.
6. (Optional) Turn on **Authentication** if needed, and then enter your **Username** and **Password** at the third-party live streaming platform.
7. (Optional) Toggle on **Quick Stream**. When it is enabled, you can start streaming quickly on the main screen.
8. Tap **Network** to set the network priority for streaming. Options include:
  - Default: The system's default network priority, that is Ethernet > WLAN > Cellular.
  - Cellular First
  - WLAN First
  - Ethernet First
9. Tap **Test** to test whether the previous configurations are working properly.

← **SRT Caller** ×

Name  
SRT Caller

---

Encode  
Encode 1

---

Address

---

Port

---

Stream ID

← **SRT Caller** ×

Latency  
120ms

---

Encryption

---

Quick Stream

---

Network  
Default

---

**Test**

## Configure **SRT Caller**

1. Select **SRT Caller** in the stream setting page.
2. Tap **Name** to enter an alias name for your convenience of multi-item management.
3. Tap **Encode**, and select a stream scheme.

You can customize encode parameters and sources as needed. For details, please refer to [Encode](#).

4. Tap **Address**, and enter the address of receiver.
5. Tap **Port**, and enter the port number of receiver. Value ranges from 1 to 65535.
6. Tap **Stream ID**, and enter a custom ID, which can contain 0-256 characters.
7. Tap **Latency**, enter a number between 20 and 8000. The default value is 120ms. We recommend that the latency is configured the same as that of the receiver.
8. (Optional) Toggle on **Encryption**, and then select an encryption algorithm, which can be [AES 128](#), [AES 192](#) or [AES 256](#). And enter the Password, which can contain 10 to 79 characters.
9. (Optional) Toggle on **Quick Stream**. When it is enabled, you can start streaming quickly on the main screen.
10. Tap **Network** to set the network priority for streaming. Options include:
  - Default: The system's default network priority, that is Ethernet > WLAN > Cellular.
  - Cellular First

- WLAN First
- Ethernet First

11. Tap **Test** to test whether the previous configurations are working properly.

**SRT Listener**

Name  
SRT Listener

Encode  
Encode 1

Port  
8080

Latency  
120ms

Encryption

srt://10.10.56.185:8080

srt://192.168.67.227:8080

**SRT Listener**

Latency  
120ms

Encryption

Quick Stream

**Test**

**Delete**

srt://10.10.56.185:8080

srt://192.168.67.227:8080

## Configure SRT Listener

1. Select **SRT Listener** in the stream setting page.
2. Tap **Name** to enter an alias name for your convenience of multi-item management.
3. Tap **Encode**, and select a stream scheme.

You can customize encode parameters and sources as needed. For details, please refer to [Encode](#).

4. Tap **Port**, and enter the port number. Value ranges from 1 to 65535.
5. Tap **Latency**, enter a number between 20 and 8000. The default value is 120ms. We recommend that you set the same latency for **SRT** caller and listener.
6. (Optional) Toggle on **Encryption**, and then select an encryption algorithm, which can be **AES 128**, **AES 192** or **AES 256**. And enter the Password, which can contain 10 to 79 characters.
7. (Optional) Toggle on **Quick Stream**. When it is enabled, you can start streaming quickly on the main screen.
8. Tap **Test** to test whether the previous configurations are working properly.
9. The stream URL is overlaid at the bottom. If you have multiple network connections, there would be multiple ones.

← **RTSP** ×

Name  
RTSP

Encode  
Encode 1

Port  
554

Stream ID  
123

Authentication

rtsp://10.10.56.185:554/123

rtsp://192.168.67.227:554/123

← **RTSP** ×

Stream ID  
123

Authentication

Quick Stream

Test

Delete

rtsp://10.10.56.185:554/123

rtsp://192.168.67.227:554/123

## Configure RTSP Server

1. Select **RTSP** in the stream setting page.
2. Tap **Name** to enter an alias name for your convenience of multi-item management.
3. Tap **Encode**, and select a stream scheme.

You can customize encode parameters and sources as needed. For details, please refer to [Encode](#).

4. Tap **Port**, and enter the port number. Value ranges from 1 to 65535.
5. Tap **Stream ID**, and enter a custom ID, which can contain 1-63 characters.
6. (Optional) Toggle on **Encryption** if your live streaming service provider requires. Type your user name and password for the streaming service.
7. (Optional) Toggle on **Quick Stream**. When it is enabled, you can start streaming quickly on the main screen.
8. Tap **Test** to test whether the previous configurations are working properly.
9. The stream URL is overlaid at the bottom. If you have multiple network connections, there would be multiple ones.

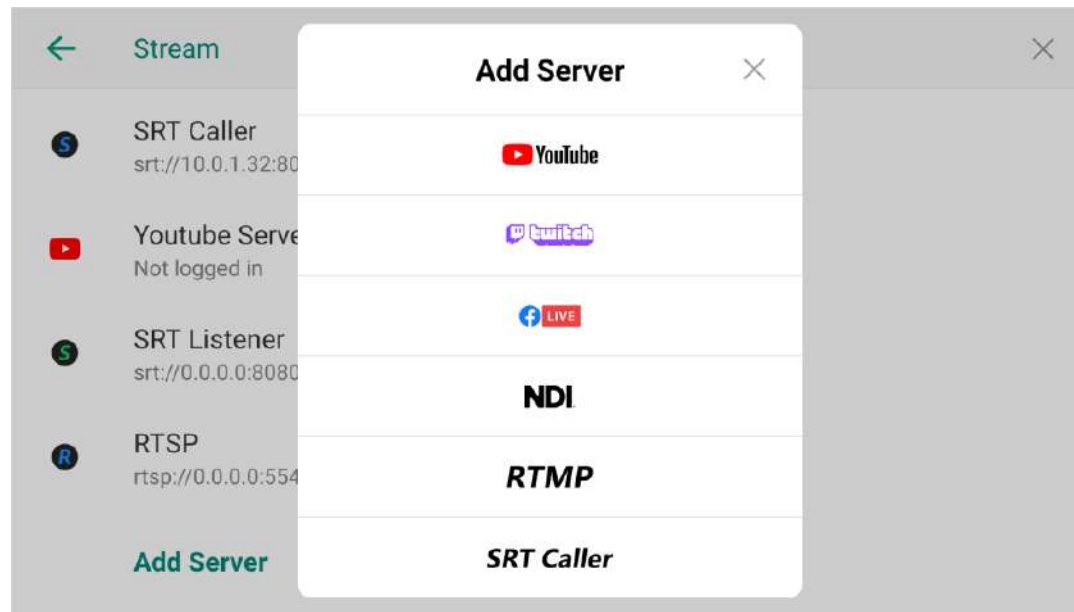

### Add More Servers

1. Select **Add Server** in the stream setting page.
2. Select one server, and operate as the previous steps.

### Edit Server

1. Tap a sever in the stream setting page.
2. Modify the server's properties.

### Delete Server

- In the stream setting page, swipe a server to the left, and then tap  .
- Or tap a server to enter its configuration page, and then tap **Delete** at the bottom.

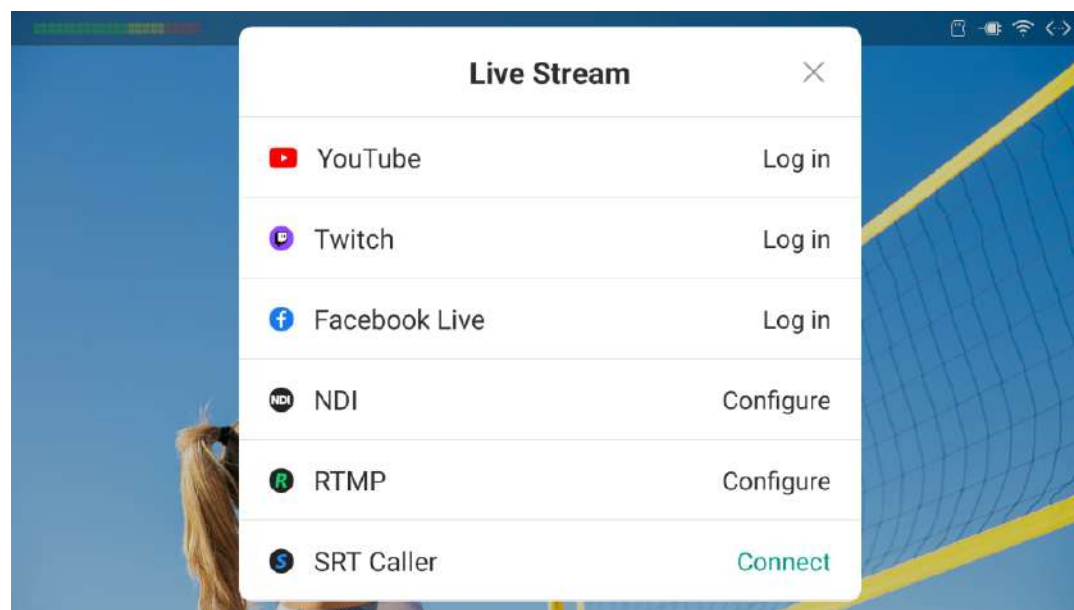

## Start Live Streaming

Director device supports streaming to four servers at the same time.

You can start live streaming through two methods: Manual Stream and Quick Stream. Manual Stream requires you to manually connect and stream to configured servers individually. Quick Stream allows you to specify up to four configured servers and quickly connect and stream to these servers at the same time.

### Manual Stream

1. Ensure your Director device is connected to the Internet.
2. Ensure you have [configured streaming sever](#).
3. Start streaming:
  - a. Tap  on the main screen.
  - b. Tap **Connect** next to a configured server in the **Live Stream** window.

If you have not configured the server, tap the server, and it will go to the configuration page.

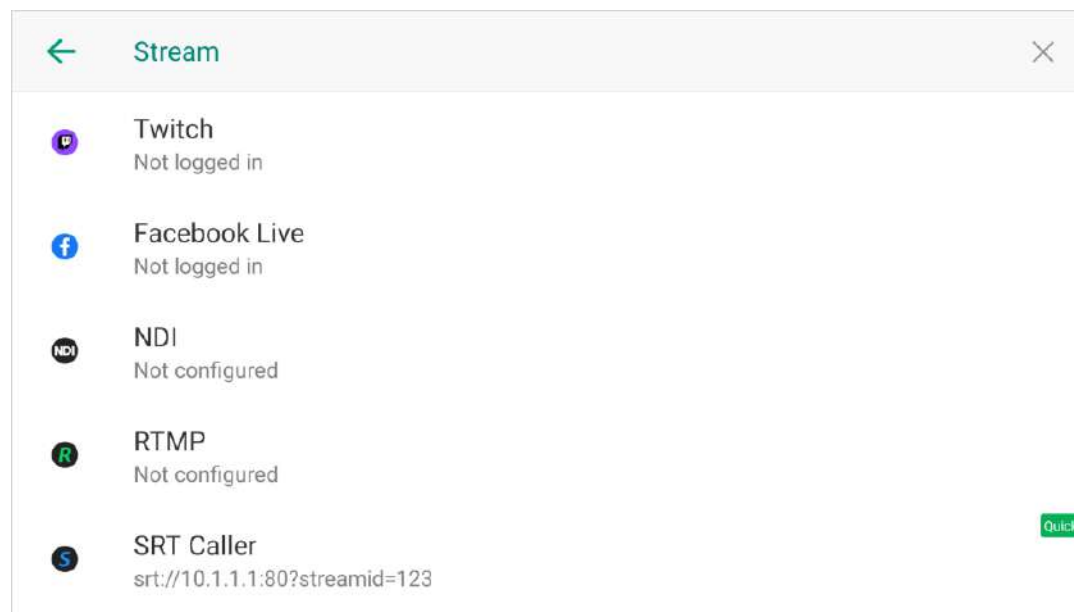

- c. (Optional) Repeat the above steps to stream to another server at the same time.
  - The maximum number of servers you can simultaneously connect to is two. This limit is set to ensure stream performance.
  - If you have not configured any other server, you cannot stream to another server, and it will not go to the configuration page when you tapping another server.

4. Stop streaming:



- a. Tap  on the main screen.
- b. In the Live Stream window, tap **Disconnect** of a working server to stop streaming to the server.
- c. (Optional) Repeat the above steps to stop streaming to the other server.

### Quick Stream

1. Ensure your Director device is connected to the Internet.
2. Ensure you have turned on **Quick Stream** when you [configure streaming sever](#).
  - You can enable **Quick Stream** for four servers at most. This limit is set to ensure stream performance.
  - You can check which server is enabled with Quick Stream by tapping  > **Settings** > **Stream**, and the server is marked with "Auto".
3. Tap  on the main screen to start streaming.
4. Tap  on the main screen to stop streaming.

The NDI server does not support Quick Stream.

For YouTube streaming, if you create a new stream to post to, it enables Auto-start by default. When you start streaming to this channel, it goes live at once on YouTube. If you need to preview the stream at first, you may refer to [How to start a stream scheduled later for YouTube](#).

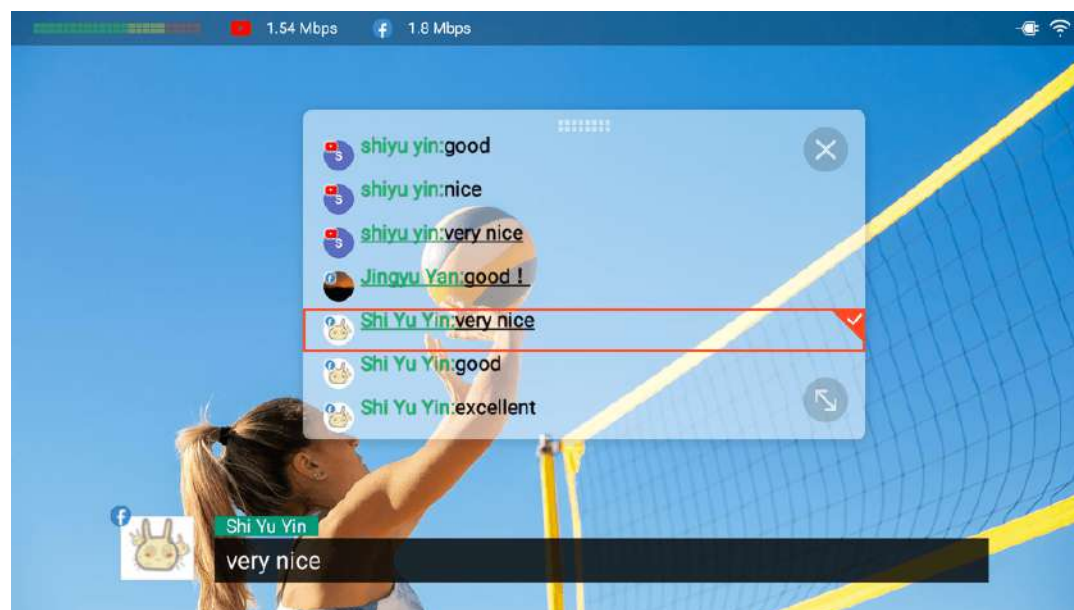
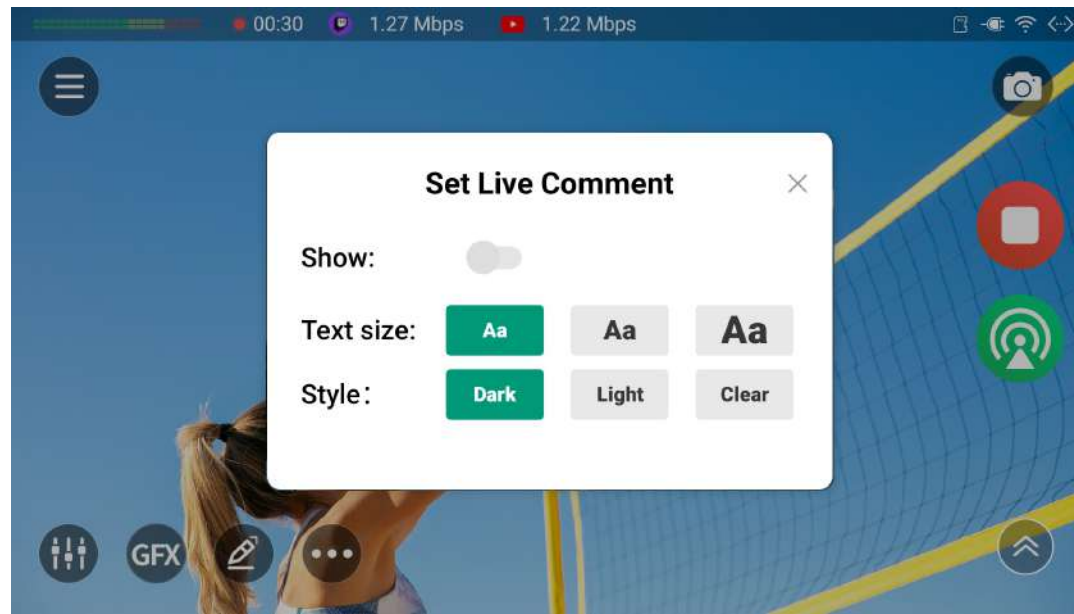

## Live Comment

You can view live comments when streaming to YouTube, Twitch or Facebook, and select one comment as an overlay inside the video feed.

1. Tap  to set live comments.
2. Toggle on **Show** to display live comment box on the screen.
3. Set text size.
4. Set the style of comment box.
5. Tap "x" to go back to the main screen.

The comment box will display real-time comments in chronological order, and the icon of the platform will be displayed on the profile picture to mark it. You can send one comment as an overlay into the Program/Preview view.

- Long-press one comment to open the setting page.
  1. Tap the arrows to switch the overlay style.
  2. Tap the checkbox of **Auto Clear** and set the duration after which the comment automatically disappears.
  3. Tap **Send** to sent it as an overlay.
- Tap the overlay comment to cancel.
- Scroll up to view earlier comments, and scroll down to view the most current comments.
- Tap the top of comment box and drag it to the desired position.
- Drag  to scale it up and down.
- Tap "x" to close the comment box.

## Record and Screenshot

You can record a show during live streaming or independently, and you can take screenshots at any time.

Director device supports isolated (ISO) recording. You can record two different sources simultaneously, or record two-channel images with different quality for one source.

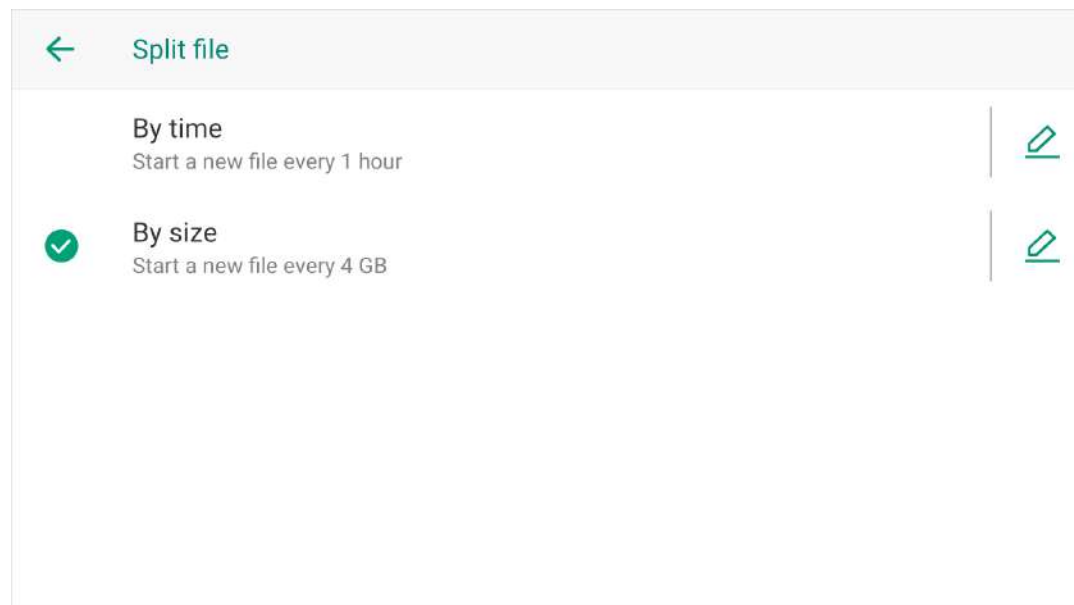
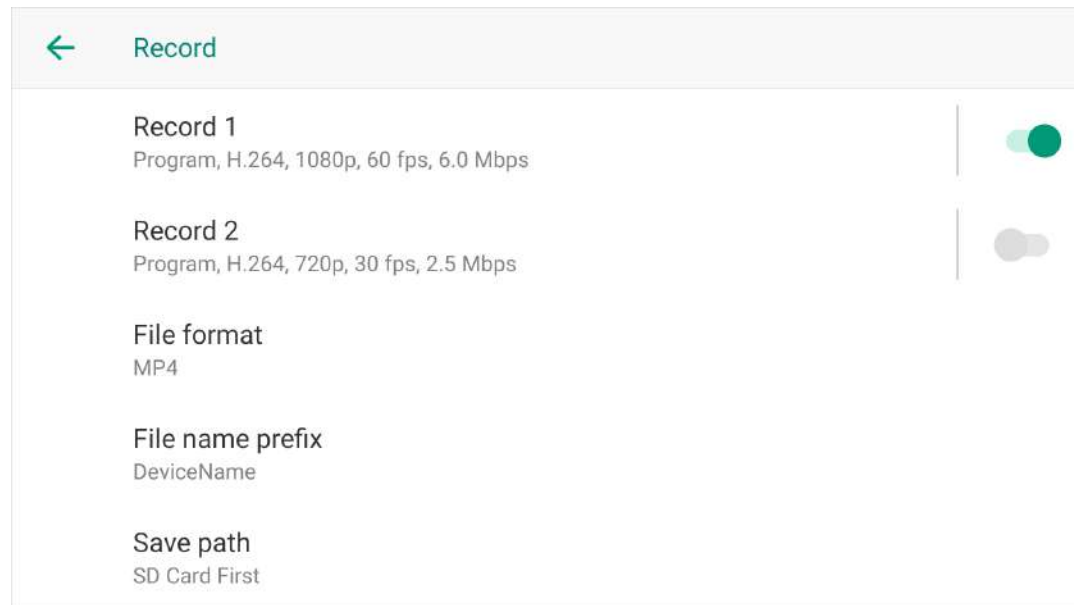

### Set Recording Properties

Before recording, you may need to set recording properties. Otherwise, it will use the default settings to record.



1. Tap  > **Settings** > **Record**.
2. Tap **Record 1** or **Record 2** to select recording source. Options include Encode 1, Encode 2, or NDI source (if added to the show).

**Encode 1** and **Encode 2** can be customized. For details, please refer to [Encode](#).



3. To enable ISO recording, please toggle on the switches of both **Record 1** and **Record 2**. If you only need to record one-channel image of one source, please toggle on one switch as needed.
4. Tap **File format** to set the format of recording file. Options include MP4 and MOV. By default, the format is MP4.
5. Tap **File name prefix**, and select a prefix type.
  - DeviceName
  - ShowName
  - DeviceName\_ShowName
  - Self-defined name: tap **Add**, enter a name, and tap **Save**.
6. Tap **Save path**, and then select your preferred path, **Internal Storage First**

or **SD Card First** (default).

You can also set storage path in [Storage](#).

7. Tap **Split file**, and then you can choose to split your recording file by time or by size. By default, it starts a new file every 4 GB.
  - **By time:** start a new file by every x minutes or x hours. Tap  to set as your preference.
    - Time length: Options include 10 minutes, 20 minutes, 30 minutes, 1 hour, 1.5 hours, 2 hours and 4 hours.
    - Hour alignment: When it is enabled, The first file will start from the current time and end on the hour, and then the second file will start, so that it is more convenient for you to view your video clips. For example, when you choose to start a new file every 1 hour, if the first file starts at 8:30:03 am, it will end at 9:00:00 am. Then the second file will start at 9:00:00 am.  
It also takes effect for x minutes. For example, when you choose to start a new file every 10 minutes, if the first file starts at 8:08:03 am, it will end at 8:10:00 am, and the second file will start at 8:10:00 am.
  - **By size:** start a new file by every x MB or x GB. Tap  to set as your preference.  
Options include 100 MB, 200 MB, 500 MB, 1 GB, 1.5 GB, 2 GB, 2.5 GB, 3 GB, 3.5 GB, 4 GB, 8 GB and 16 GB.

## Start Recording

1. On the main screen, tap  to start recording.
2. Tap  to stop recording.

 When the recording time is less than 1s, the recording file will not be saved.  
ISO recording does not support Full NDI source.

## Take Screenshots

Tap  to take a screenshot of the program output. Screenshots are saved as .PNG files in the internal storage by default. If you want to change the save path, please refer to [Storage](#).

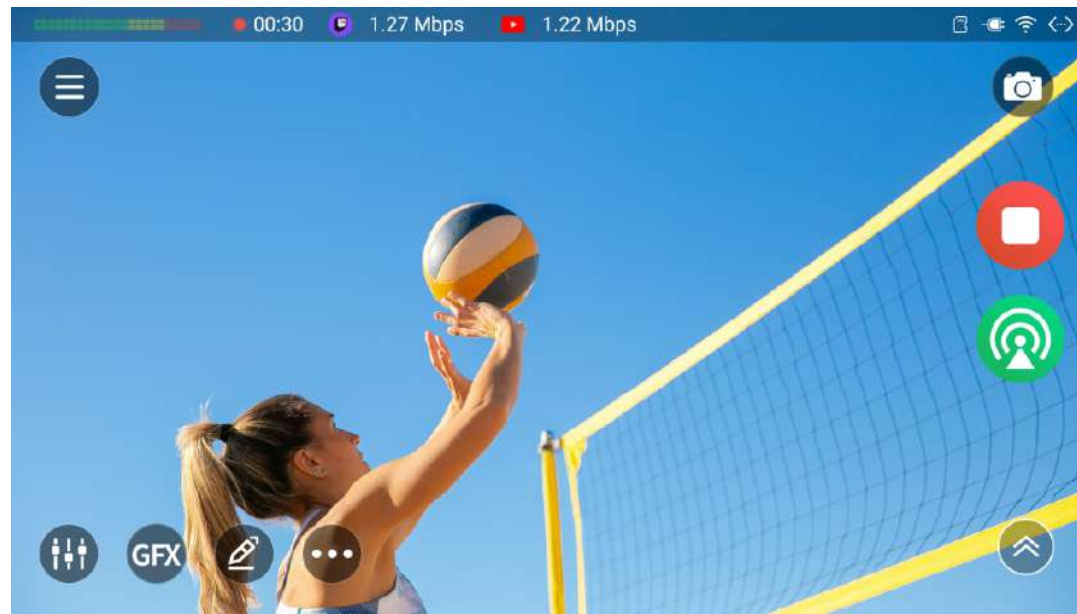

## Check Streaming/Recording Status

### Recording status

Once you start recording, the recording status will be displayed on the status bar. It is marked by a flashing red dot, showing the recording duration. When the time left for record is less than 1 hour, it displays "Time left: xx:xx" in red text.

When the remaining free space is insufficient, the device will stop recording automatically. The recording status disappears from the status bar.

### Streaming status

Once you start streaming, the streaming status will be displayed on the status bar. It is marked by the logo of streaming server, showing the streaming rate. When you stream to multiple servers at the same time, it displays information of these servers.

- **Orange streaming text:** The upload speed is not enough to support bandwidth.
- **Red streaming text:** Director device is trying to reconnect to the streaming server.

You can also view streaming status on the [Control Center](#).



## NDI Tally

When you start NDI streaming, the top status bar supports displaying NDI Tally.

- When the streaming rate shows a red background, it indicates the NDI streaming signal is in PGM (Program) view.
- When the streaming rate shows a green background, it indicates the NDI streaming signal is in PVW (Preview) view.



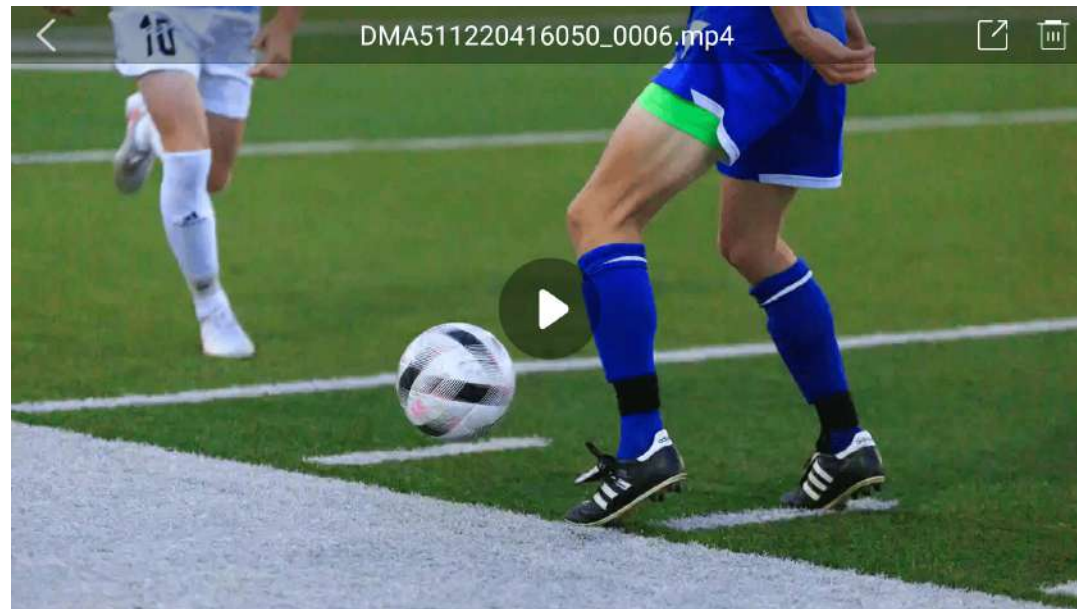

## Album

The Album displays videos you have recorded, replay events you have set, screenshots you have taken by pressing  or the power button, which are stored in the internal storage or SD card, and sorted by time.

In the album, you can preview, export, and delete the images or video clips.



### Preview Video Clips & Images

1. Tap  > **Album** to open the Album, and tap the "Record", "Replay" or "Screenshot" tab to switch pages.
2. Tap a video clip or an image to preview it in full screen.
3. While previewing, you can
  - Tap  or  in the upper right corner to export or delete the video or image.
  - Use the video progress bar to control video playback.
4. Tap  to go back.

When you preview the video clip of Record, you can see the file name which is assigned in the format of "prefix\_number sequence of recording\_number sequence of split file\_source\_REC1/2.file extension".

- Prefix: the file name prefix set in [Record](#).
- Number sequence of recording: it returns to the start of the number sequence (0001 for the file) each time you reset the device.
- Number sequence of split file: for a long-time recording, files are split in number sequence. If no file is split, no such number.
- Source: the recording source, which can be PGM, HDMI1, HDMI2,

WEBCAM1, WEBCAM2 or NDI.



- REC1/2: indicating Record 1 or Record 2.
- File extension: set in [Record](#), which can be MP4 or MOV.

When you preview the replay event, you can see the file name which is assigned in the format of "prefix\_number sequence\_source\_REPLAY1/2(*EVENT No.*).file extension".

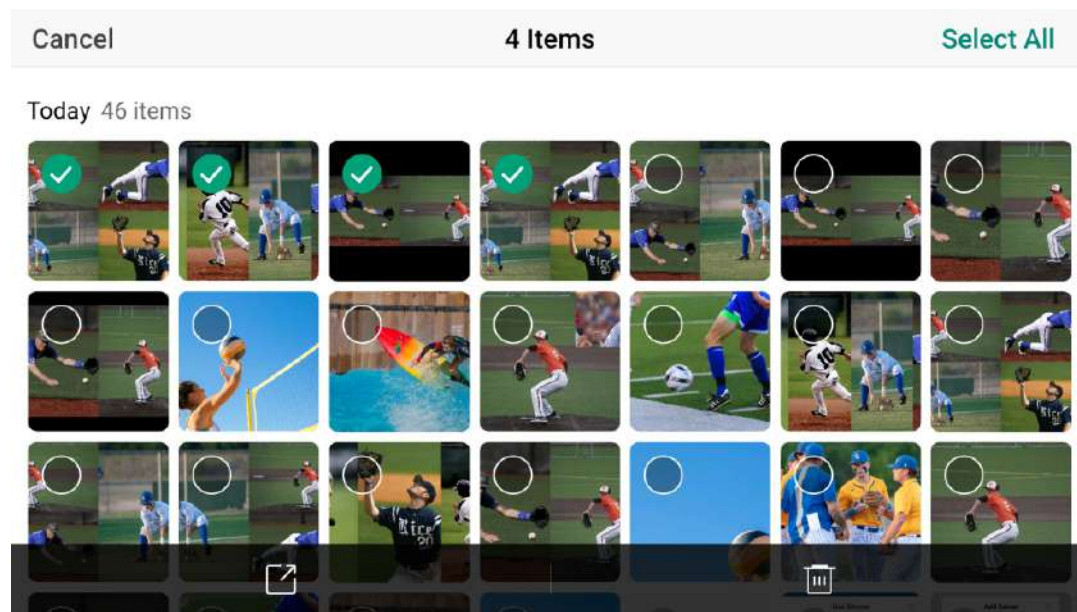
- Prefix: the file name prefix set in [Record](#).
- Number sequence: it returns to the start of the number sequence (0001 for the file) each time you reset the device.
- Source: the recording source, which can be PGM, HDMI1, HDMI2, WEBCAM1, WEBCAM2 or NDI.
- REPLAY1/2: indicating replay camera 1 or 2.
- EVENT No.: indicating the Event number, in the sequence when it is set.
- File extension: set in [Record](#), which can be MP4 or MOV.



## Export or Delete Video Clips & Images

1. Tap  > **Album** to open the Album, and tap the Record, Replay or Screenshot tab to switch pages.
2. Tap **Select**, and then select some video clips or images.
3. Tap  at the bottom, then select USB or SD Card to export the selected items.
4. Or tap  at the bottom to delete the selected items.



If you export a file in the internal storage to the SD card, two same files will be displayed in the album.

# Manage Media Files

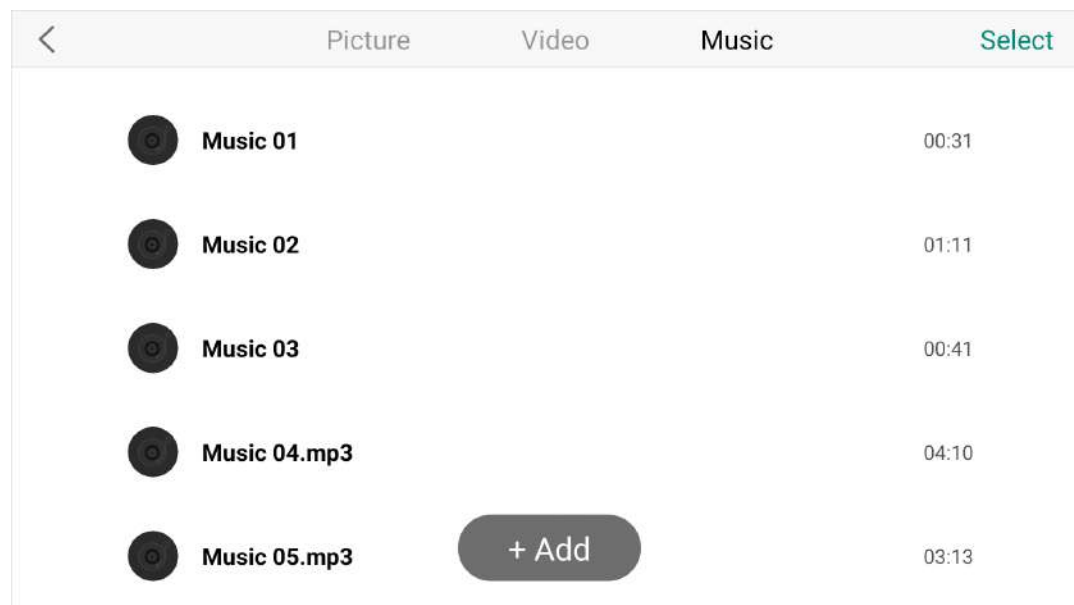
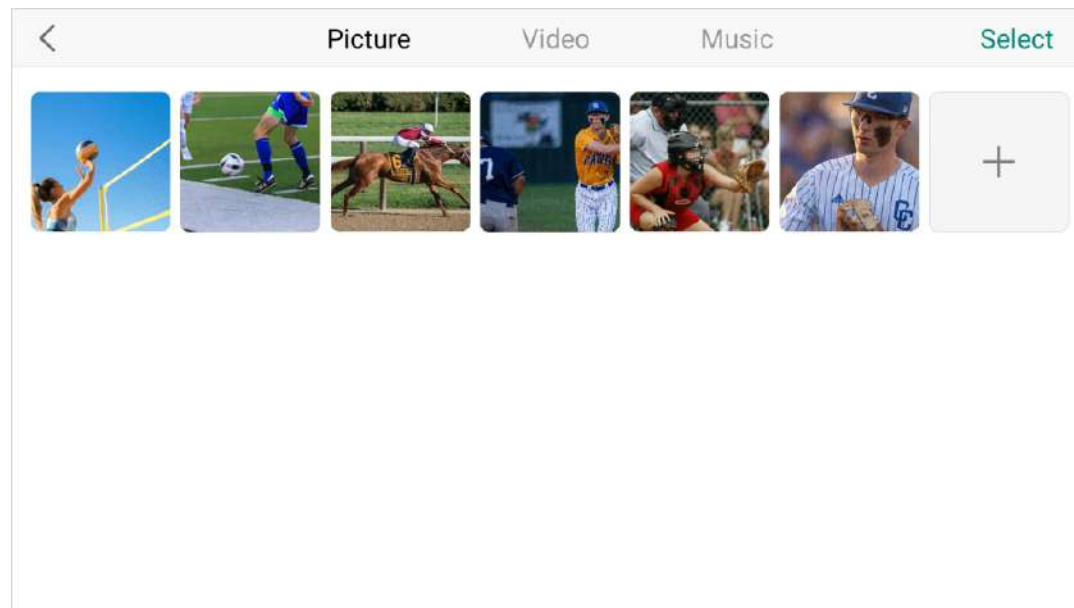
In the media file library, you can upload pictures, video clips and music files as resources for your shows, and you can manage these files.



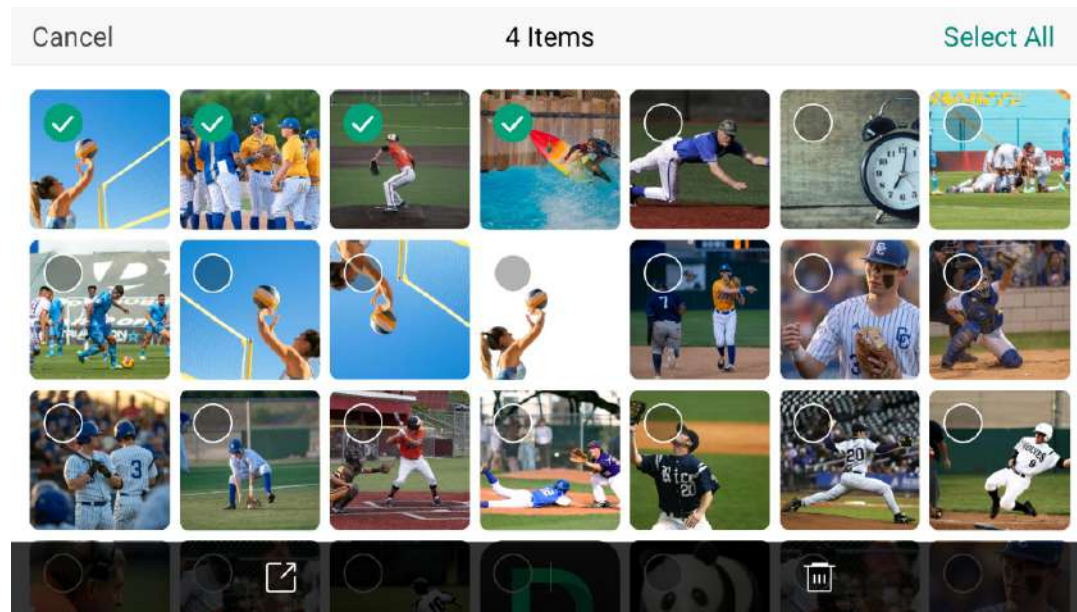

## Upload Media Files

1. Tap  > **Media file**, to enter the media file library.
2. Tap **Picture**, **Video** or **Music** to switch pages.
3. Tap + or + **Add** and then select files from the storage to upload.
4. Tap the uploaded file to preview the source. While previewing a picture or video, you can tap  or  in the upper right corner to export or delete the file.



## Export or Delete Files

1. Tap  > **Media file**, to enter the media file library.
2. Tap **Picture**, **Video** or **Music** to switch pages.
3. Long-press a file or tap **Select**, and then select some media files. Or, you can tap **Select All** to select all the files.
4. Tap  at the bottom, then select USB or SD Card to export the selected items.
5. Or tap  at the bottom to delete the selected items.

# Settings

Tap  > **Settings** to open the settings page, where you can customize the properties of the device, configure encode parameters, set audio, etc.

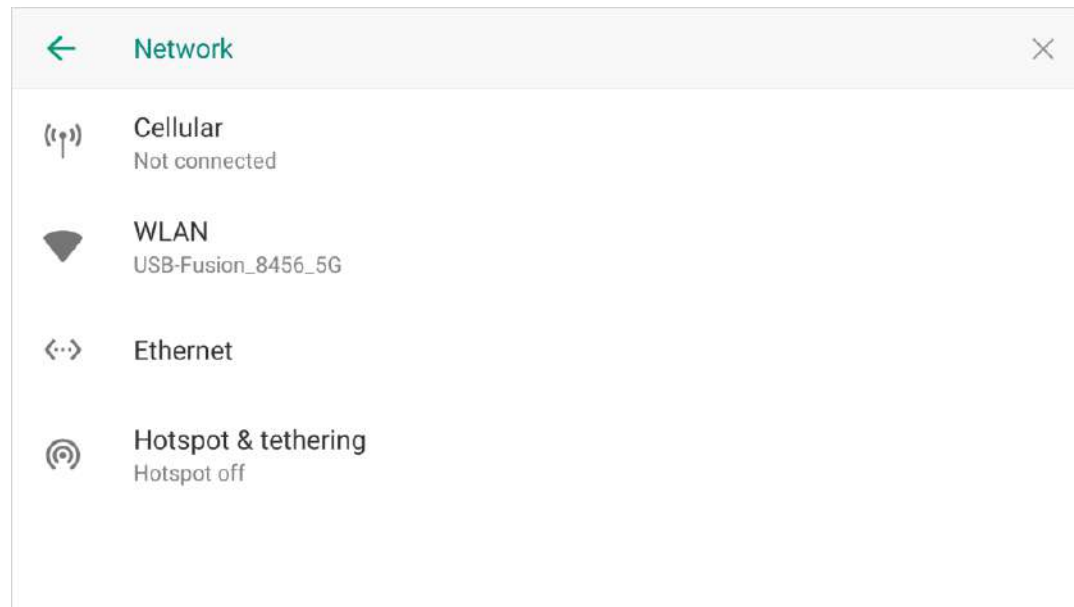

## Network

Director device supports multiple network connections, including wired, Wi-Fi and cellular network. These networks can be connected at the same time. The priority order for the device selecting network connection is wired > Wi-Fi > Cellular network.

### Cellular

You can insert one or more USB Modems for Internet connection, and check the USB Modem information in the Cellular list.

You can also share the Internet data connection available on your mobile smartphone with Director device through a USB cable, and view the phone's information in the Cellular list.

For Director One, you can insert one SIM card to the 4G SIM card slot, and check the SIM card information in the Cellular list. Tap it to enable or disable the card and view more information. In addition, you can implement more advanced settings, such as APN, roaming and TTL.

### Wi-Fi

You can connect your device to a Wi-Fi network to access the Internet and other devices.

#### Connect to a Wi-Fi network

1. Tap **WLAN**, and then toggle on the switch to enable Wi-Fi.
2. Select a Wi-Fi in the displayed list to connect.

- The Wi-Fi with a lock icon requires password.
  - If a Wi-Fi network requires authentication, it will pop up the captive portal, and you can access the network following the on-screen introduction.
3. You can tap the connected Wi-Fi to check more network details, such as signal strength, frequency, security, MAC address, IP address, Gateway, Subnet mask, DNS, and link speed.
  4. To delete a Wi-Fi, you can tap the connected Wi-Fi and then tap FORGET. Or you can tap **Saved networks** at the bottom, and tap a Wi-Fi to delete, and then tap FORGET.

### Add a Wi-Fi network

When the router's **SSID** (wireless signal name) is hidden, the device cannot search for the router's wireless signal. It needs to manually enter the router's **SSID**, wireless password and other parameters to connect to the router's wireless signal.

1. Tap **WLAN**, and then toggle on the switch to enable Wi-Fi.
2. Scroll the network list to the bottom, and tap **Add network**.
3. Enter **SSID**, and set Security by selecting the same encryption mode as the router and entering the password if needed.
4. Tap **Save**.

### Wi-Fi Direct

Wi-Fi Direct uses Wi-Fi to share data between devices.

1. Tap **WLAN**, and then toggle on the switch to enable Wi-Fi.
2. Scroll the network list to the bottom, tap **Wi-Fi preferences > Wi-Fi Direct**. It lists all the detected devices.

3. Tap a device, and then follow the prompts to connect. To disconnect from Wi-Fi Direct, tap a connected device to disconnect it.
4. (Optional) Tap **RENAME DEVICE**, enter a new name, and tap **OK**.

## Ethernet

Ethernet is enabled by default. If you want to disable the Ethernet connection when it is in bad status, tap **Ethernet**, and then toggle off the switch. To enable the Ethernet connection, toggle on the switch.

You can tap **Ethernet configuration** to check and set more information, including connection type (DHCP or Static IP), IP address, network prefix length, DNS address and gateway address.

## Hotspot & Tethering

This function uses your device as a mobile hotspot to share your network connections with other devices.

1. Tap **Hotspot & tethering** > **Wi-Fi hotspot**, and toggle on the switch to enable hotspot.
2. Set the hotspot name.
3. Set security. If you select WPA2 PSK, set the hotspot password.
4. Tap **Advanced** to set whether to turn off hotspot automatically and select AP Band. Please refer to [Which AP band should I choose for hotspot](#).

To ensure the connection effect, when 5G is selected, the recommended optimal connection distance is within 5 meters, and a maximum of 5 devices can be connected. When 2.4G is selected, the recommended optimal connection distance is within 5 meters, and a maximum of 2 devices can be connected.

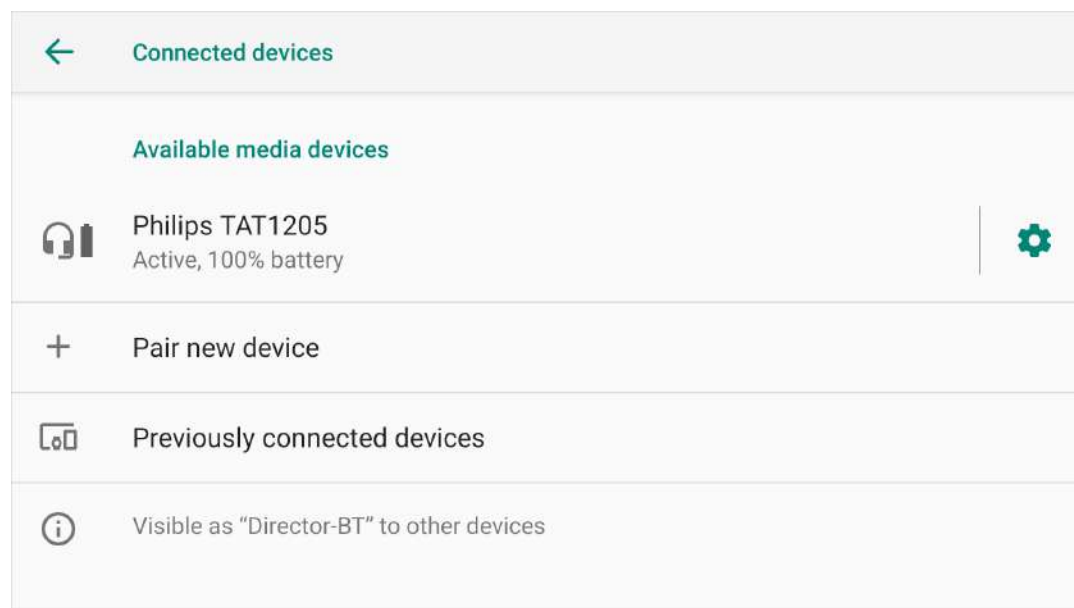
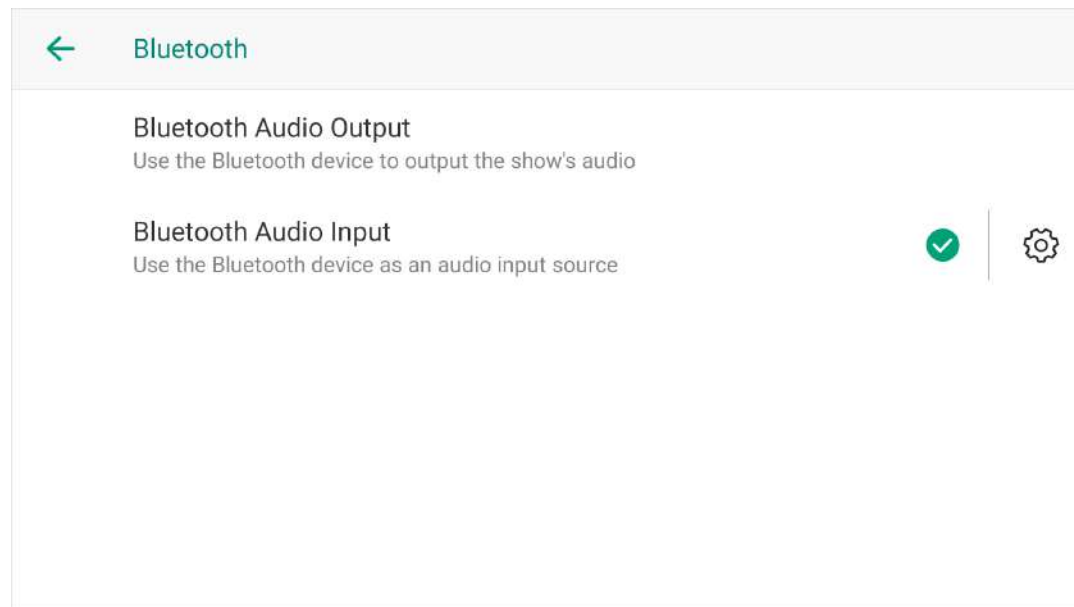





## Bluetooth

You can use your Bluetooth device for audio output or audio input.

1. Tap **Bluetooth** in the settings page.
2. Select Bluetooth audio usage.
  - **Bluetooth Audio Output:** Use the Bluetooth device to output the show's audio. (default)
  - **Bluetooth Audio Input:** Use the Bluetooth device as an audio input source.

When you change the mode, the device needs to restart.

3. Tap  on the right.
4. Tap **Pair new device**.
5. (Optional) Tap **Device name** to rename the device name for Bluetooth pairing.
6. Select a Bluetooth device from the list of Available devices.
7. Go back to the previous page, and the device is listed in **Available media devices**.
8. To disconnect the Bluetooth device, tap  > **DISCONNECT**, and return to the previous page.
9. To reconnect a device, tap **Previously connected devices**, select the device to reconnect, and tap  > **CONNECT**.
10. To delete the Bluetooth device, tap  > **FORGET** > **FORGET DEVICE**.

- The relative pages may differ with BT device of different brands, vendors and types. Please operate according to the page prompts.
- You can also connect other Bluetooth devices for more controls, for example, connecting a Bluetooth keyboard for [shortcuts control](#).

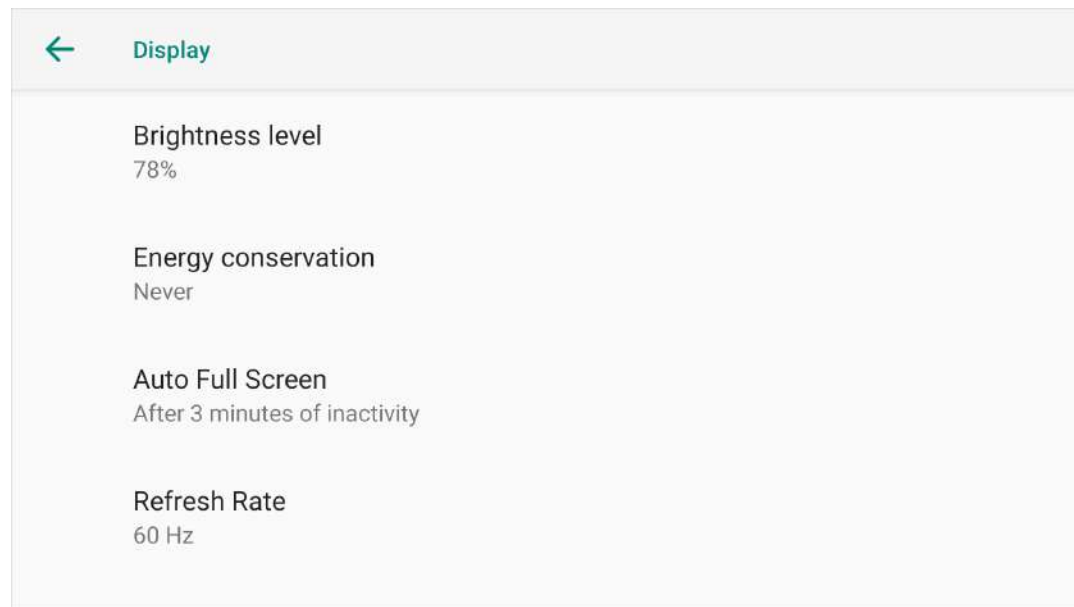

## Display

Display settings helps you conserve battery and processing power.

- **Brightness level:** move the brightness slider to the right or left to adjust the brightness.
- **Energy conservation:** choose the amount of time you want to activate energy conservation.  
The screen will turn dark after the set time when there is no activity. It is not enabled by default.
- **Auto Full Screen:** choose a duration. If no operation for a long time, the main screen automatically enters the full-screen mode, hiding all the thumbnails and buttons to conserve battery and processing power. Options include 3 minutes, 5 minutes, 10 minutes, 30 minutes, and never.
- **Refresh Rate:** select 50Hz or 60Hz as needed. (Only available for Director One)
- **Colors:** choose one mode you like. Options include Natural, Boosted, Saturated, and Custom. The Custom option allows you setting preferred color by dragging the sliders on the popup.

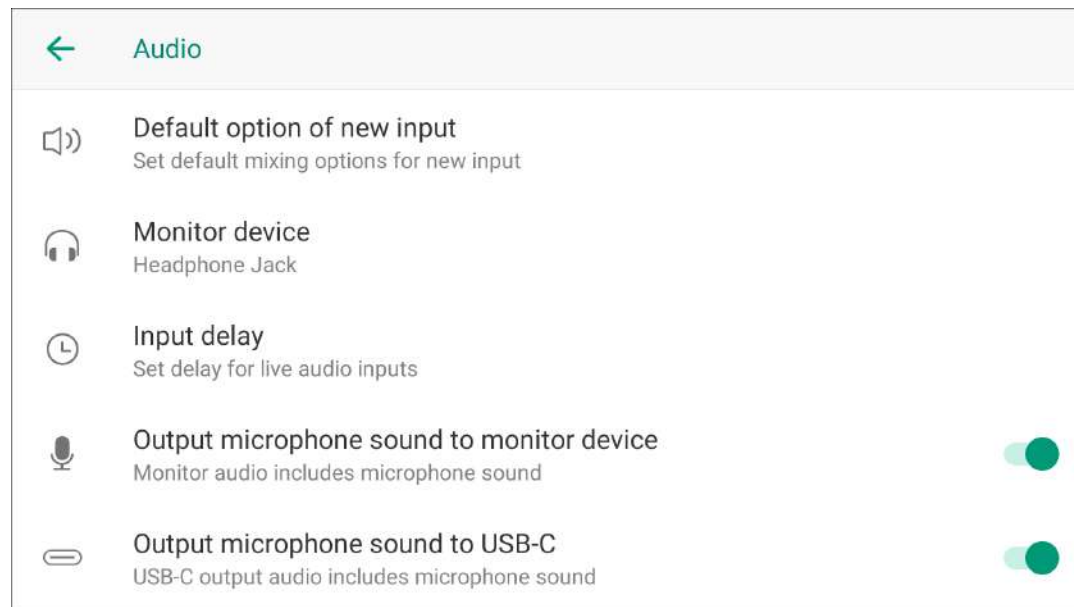

## Audio

Tap **Audio** in the settings page, to set the properties of audio.

- **Default option of new input:** set the default mixing options for an audio input when it newly connects to the device.
- **Monitor device:** select a monitor device.
  - Headphone Jack: device connected to the headphone jack
  - Bluetooth Device: device connected through BT
  - *USB device:* USB device(s) connected to Director device. The system automatically lists device name(s).
- **Input delay:** set delay for live audio inputs, to match up the audio and video tracks. You can set the delay for inputs from microphone jack, HDMI 1, HDMI 2, and external USB device(s).
- **Output microphone sound to monitor device** (enabled by default): In some cases, you may want to input your own microphone using the 3.5mm mic/line input for narration while monitoring the other audio and video sources. To exclude your own microphone audio from only your headphones or Bluetooth connection, toggle the audio off. If you are using the 3.5mm mic/line input from a soundboard and need to monitor that audio source all the time, toggle the audio on.
- **Output microphone sound to monitor device** (enabled by default): For example, if you don't want microphone audio to play on a large-screen monitor, toggle it off. To play microphone audio in sync, toggle it on.

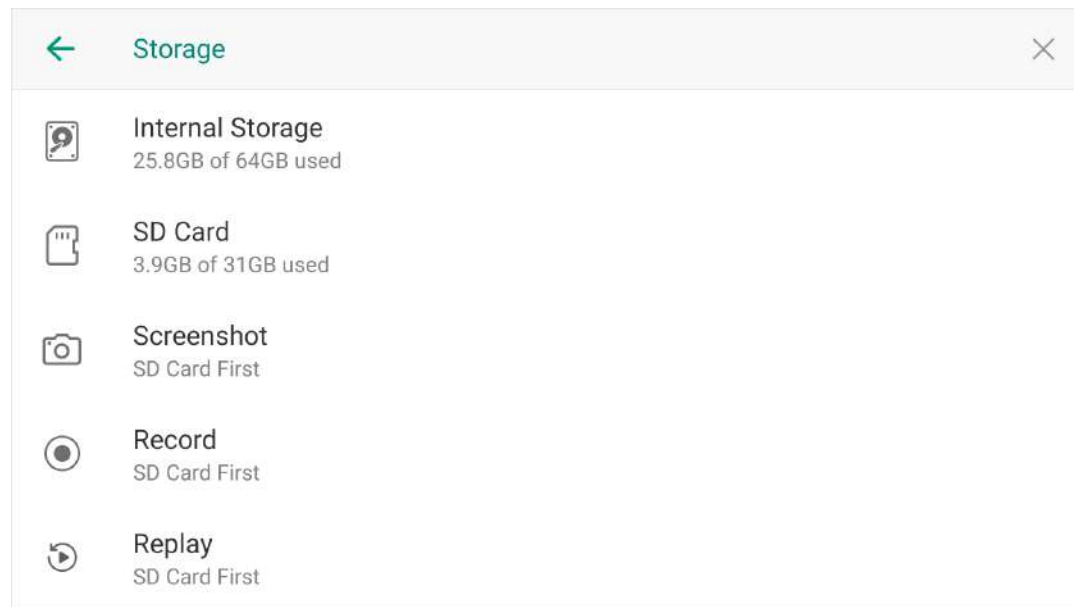

## Storage

Tap **Storage** in the settings page, to check the storage status of internal storage and SD card, and set storage path for screenshot and record.

1. Tap **Internal storage**.
  - At the top, you'll see a color-coded bar showing how much space the device has left, how much is taken up, and what's taking it up.
  - Below there shows how much space is taken by **Show** and **Record and screenshot** respectively. You can tap on each item to view more details and delete files.
  - The last line shows the remained time for recording.
2. Tap **SD Card**
  - At the top, you'll see a color-coded bar showing how much space the SD card has left, how much is taken up, and what's taking it up.
  - Below there it shows how much space is taken by **Record and screenshot**. You can tap the item to view more details and delete files.
  - The following line shows the remained time for recording.
  - The last line is the Format function. Tap it to format the SD card.
3. Tap **Screenshot**, and then select your preferred path, **Internal Storage First** or **SD Card First**.
4. Tap **Record**, and then select your preferred path, **Internal Storage First** or **SD Card First**.
5. Tap **Replay**, and then select your preferred path, **Internal Storage First** or **SD Card First**.

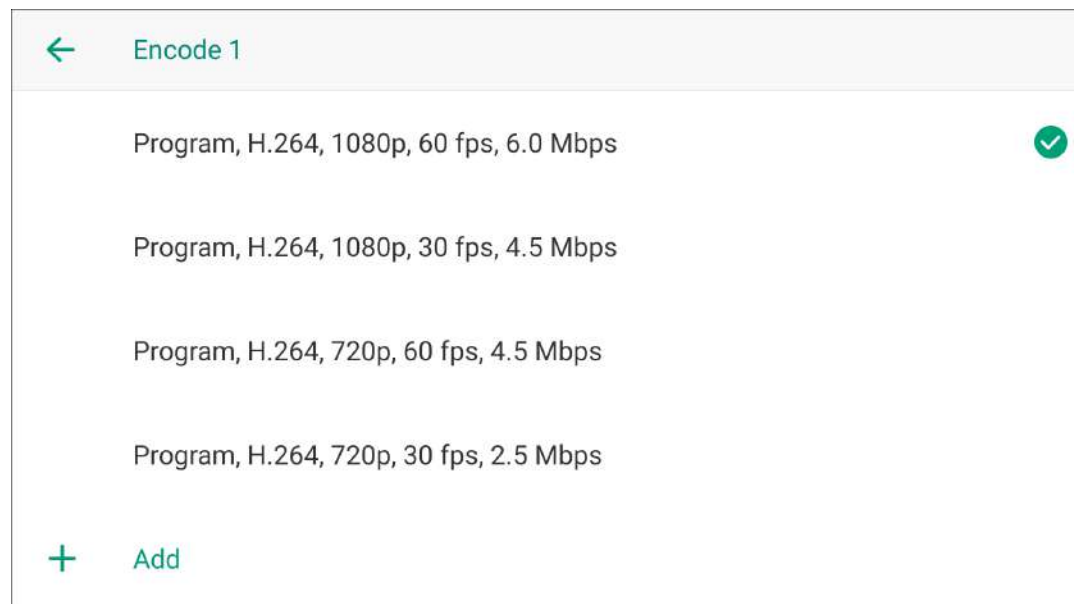
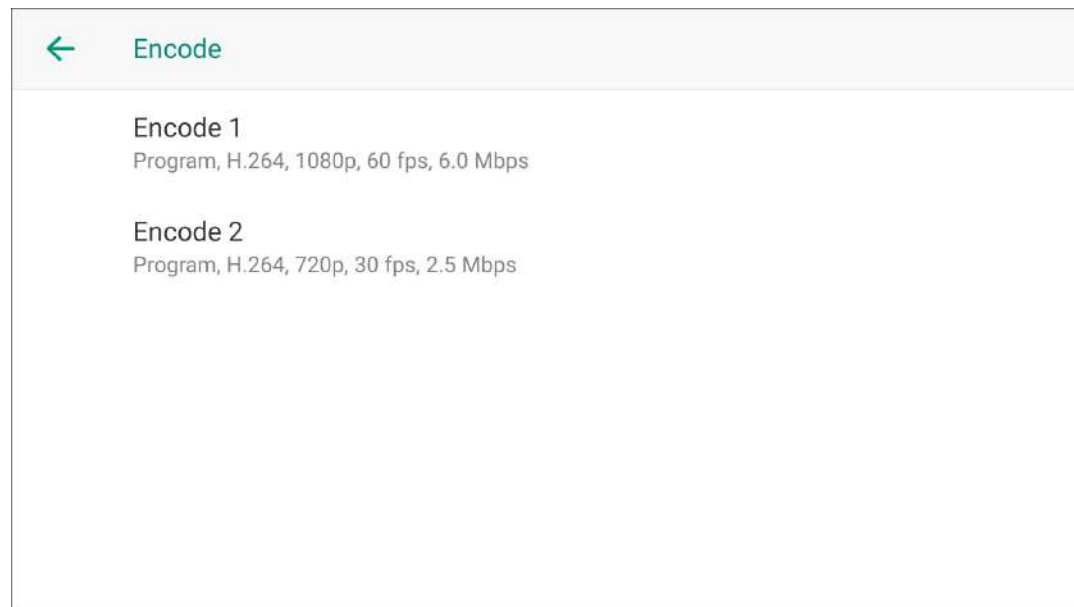

## Encode

Each show has two encoders for selection when you configure stream servers and record parameters. You can customize encoding parameters and select encoding source for Encode 1 and Encode 2.

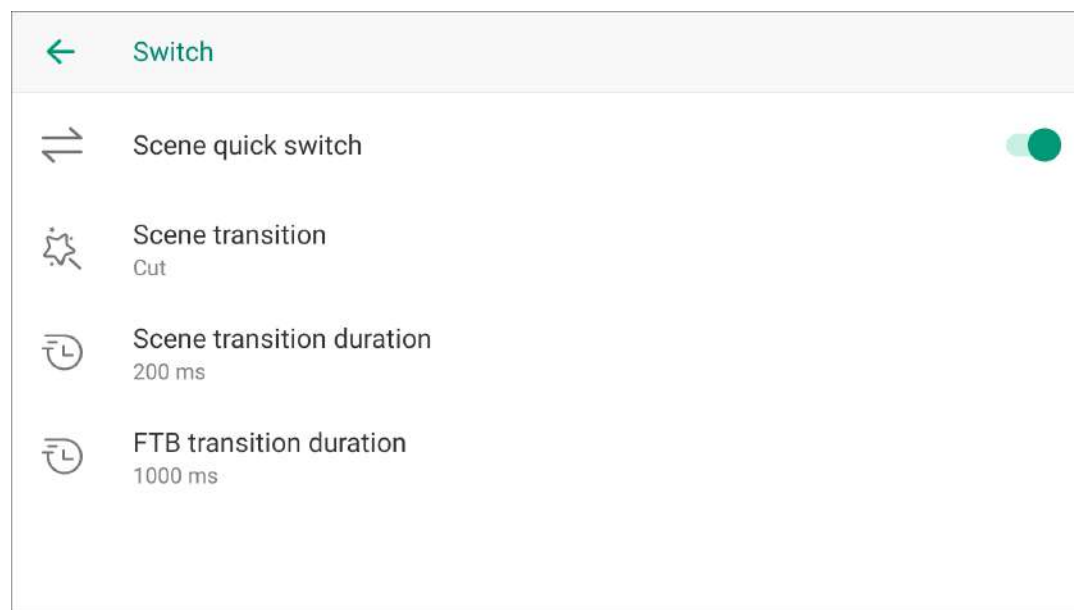

1. Tap **Encode** on the settings page.
2. Tap **Encode 1** or **Encode 2**.
3. (Optional) Tap **+ Add** to customize an encode scheme with the following parameters, and then tap **Add**.
  - Video source: Program, HDMI 1, HDMI 2, Webcam 1, Webcam 2, Multi-view.
  - Codec: H.264, H.265
  - Resolution: 540, 720, 1080
  - Frame rate: Options change along with the frame rate of the show, which can be 60/59.94/50/30/29.97/25/24/23.98/15 fps.
  - Video bitrate: enter a custom value.
  - Audio source: Program, HDMI 1, HDMI 2, MIC, available USB MIC, and None
  - Audio bitrate: 64, 96, 128
  - Advanced:
    - Key frame interval: tap + or - to set
    - Encode profile: Baseline, Main, High
    - Encode level: Options change along with the encode profile, resolution, frame rate, and video bitrate.
    - Bitrate mode: **VBR**, **CBR**





4. Select an encode scheme from system options or custom options. System options use Program as the default encoding source.
5. To edit an existing encode scheme, swipe it left and tap **Edit**.
6. To delete an existing encode scheme, swipe it left and tap **Delete**.

## Switch

Tap **Switch** on the settings page to set switch mode and transition effect.

- **Scene quick switch:** set scene switch mode.
  - Toggle on the switch to enable quick switch mode (default). When you tap thumbnails in the scene list, it switches scenes directly.
  - Toggle off the switch to enable manual switch mode. When you tap a thumbnail in the scene, you can preview the scene, and then switch the scene into the Program view.
- **Scene transition:** select transition effect.
  - **Cut:** Scenes switch directly.
  - **Fade:** Scenes switch with a fade effect.
  - **DIP:** Scenes switch with a two-step transition with a color flash in the middle of the transition. Tap  for more settings.
  - **Wipe:** One scene is replaced by another gradually sweeping across the screen. Tap  for more settings.
  - **DVE:** One scene is replaced by another according to a 2D DVE pattern. Tap  to select a DVE effect.

- **Stinger:** A stinger is played over the top to cover the transition. Tap  for more settings.
- **3D:** One scene is replaced by another according to a 3D pattern. Tap  to select a 3D pattern.
- **Scene transition duration:** set transition duration.
  - Enter the value, ranging from 50ms to 1000ms, and then tap Save.
- **FTB transition duration:** set transition duration for **FTB**.
  - Enter the value, ranging from 200ms to 2000ms, and then tap Save.

### DIP Settings

- **Onset:** Duration from the current scene to the color flash.
- **Offset:** Duration from the color flash to the next scene.
- **Hold:** Duration that the color flash is held. This value is the residual of the total transition duration minus the onset and offset.
- **Color:** Select a preferred color.

### Wipe Settings

- **Angle:** Set the angle of linear wipe.
- **Line 1/2/3:** By default, the line is invisible. Toggle on the switch to display the line and tap  to set thickness, color and transparency.

### Stinger Settings

- **Thumbnail:** Tap a thumbnail to select a stinger, and tap it again to replace the default stinger with your own one. The stinger should be an MP4, MOV or WebM file within 1 to 5 seconds.

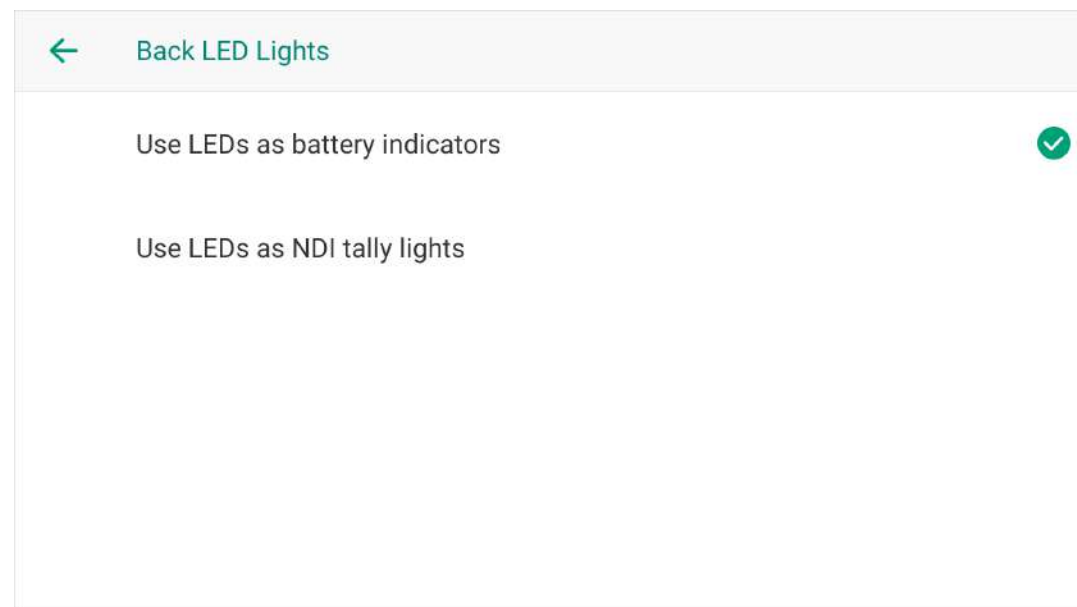

- **Chromakey:** Toggle on Chromakey and set similarity, smoothness and spill, to remove the background.
- **Enable audio:** If your video contains audio, you can toggle on **Enable audio** and adjust the audio volume.

## Back LED Lights

You can customize the function of the back LED lights.

- **Use LEDs as battery indicators:** to indicate the battery status. For details, please refer to [Battery Indicator](#).
- **Use LEDs as NDI tally lights** to indicate the signal status for NDI streaming. Red indicates the NDI signal is in PGM view, while green indicates the NDI signal is in PVW view. The two LED lights correspond to the 2 channels of NDI streaming, and keep consistent with the NDI Tally on the top status bar. For details, please refer to [NDI Tally](#).

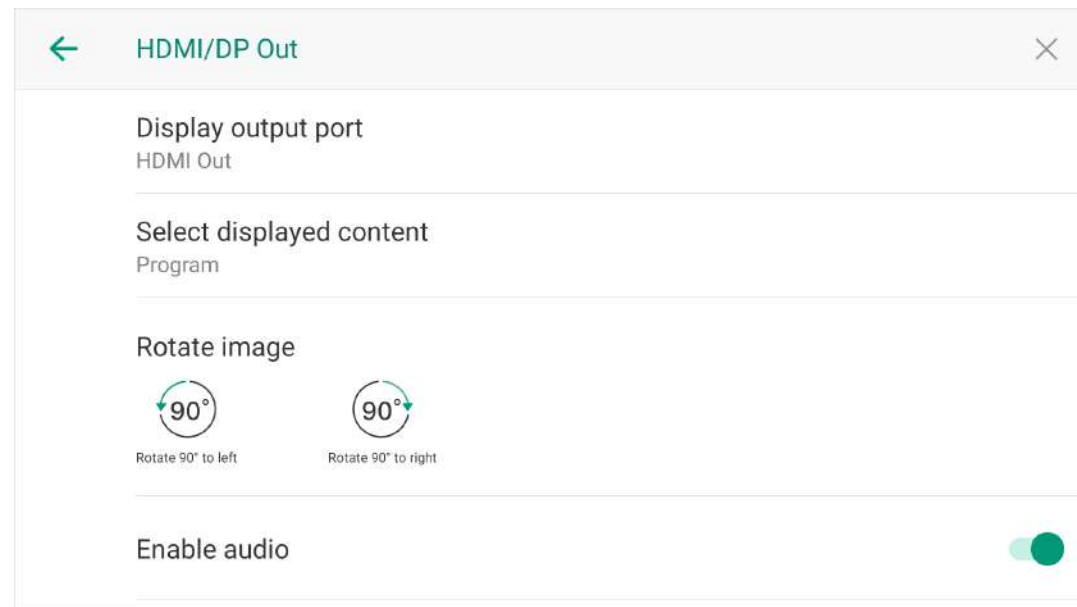

## HDMI/DP OUT

The HDMI/DP OUT option is only available for Director One.

- Display output port:
  - **HDMI Out:** Use the HDMI Out port for display output, supporting connecting an external screen or other devices supporting HDMI signal.
  - **DP (USB-C) Out:** Use the USB-C Out port for display output, supporting connecting an external screen or other devices supporting DP signal.
- Select displayed content:
  - **Program**
  - **Preview**
  - **Multi-view:** Tap  to [set multi-view appearance](#).
  - **Duplicate Screen**
  - **Loop HDMI 1**
  - **Loop HDMI 2**
- Select the rotation angle to fit for the external screen: rotate 90° to left, or rotate 90° to right.
- Set whether to enable the audio output through the HDMI output or DP output.
- Set whether to pop up the quick setting when an external screen is detected.

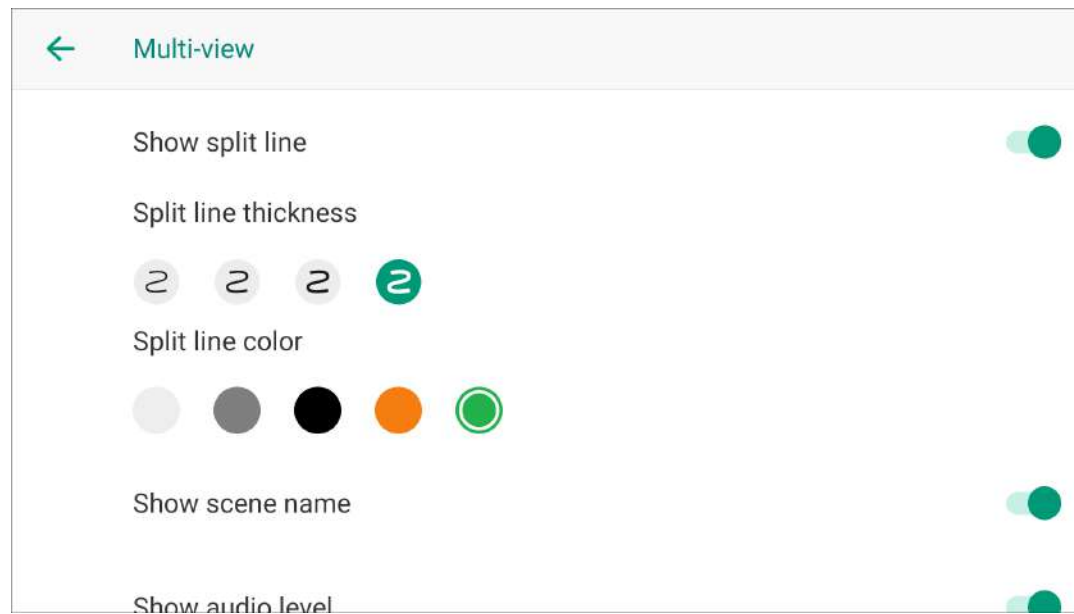

## Set Multi-view

You can tap  on right side of **Multi-view** for more settings.

- **Show split line:** toggle on/off the switch to show or hide split lines.
- **Split line thickness:** select your preferred thickness for split lines.
- **Split line color:** select your preferred color for split lines.
- **Show scene name:** toggle on/off the switch to show or hide scene names.
- **Show audio level:** toggle on/off the switch to show or hide audio level.
- **Show Preview/Program text:** toggle on/off the switch to show or hide Preview/Program text.

On the external screen connected to the Director device, you can see 8 video boxes at the bottom, displaying the scene thumbnails, and two larger boxes at the top, with the left one showing Preview view and the right one showing Program view.

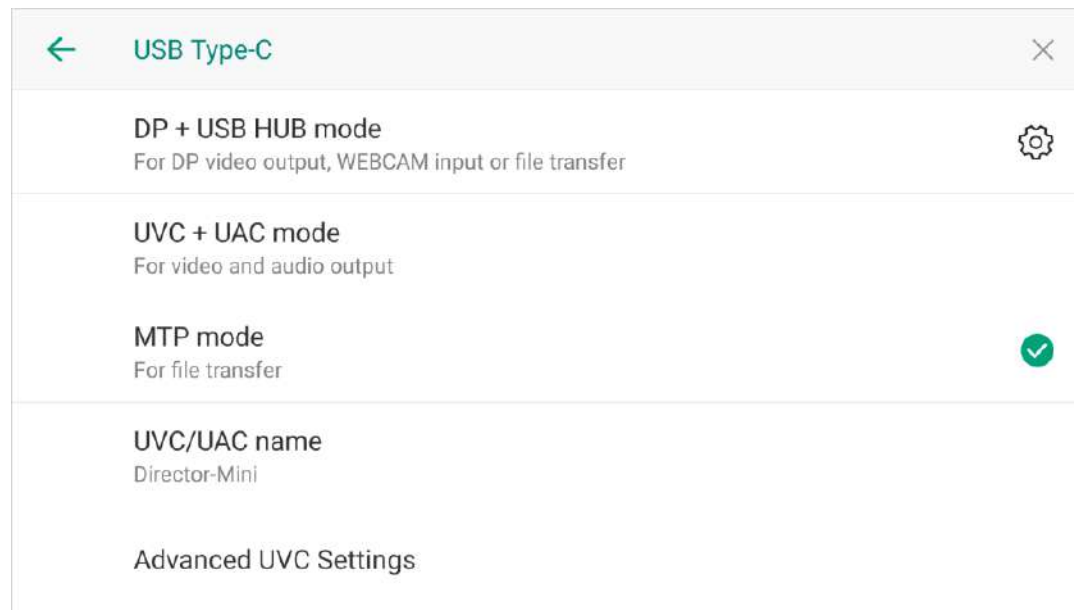



## USB Type-C

The USB-C port plays a multifunctional role. You can set its usage mode.

- **DP + USB HUB mode:** this mode is used for connecting external screen for video output, connecting WEBCAM for video input, or connecting a USB flash drive for file transfer, such as importing and exporting shows.

This option is only available for Director Mini

Tap  on the right to set the external screen.

- Select displayed content:
  - **Program**
  - **Preview**
  - **Multi-view:** Tap  to [set multi-view appearance](#).
  - **Duplicate Screen**
  - **Loop HDMI 1**
  - **Loop HDMI 2**
- Select the rotation angle to fit for the external screen: rotate 90° to left, or rotate 90° to right.
- Set whether to enable the audio output through the USB-C output.
- Set whether to pop up the quick setting when an external screen is detected.
- **UVC + UAC mode:** this mode is used for connecting to a computer for video and audio output. Director device can be recognized as a webcam by streaming software, such as Skype and Zoom. (Default)

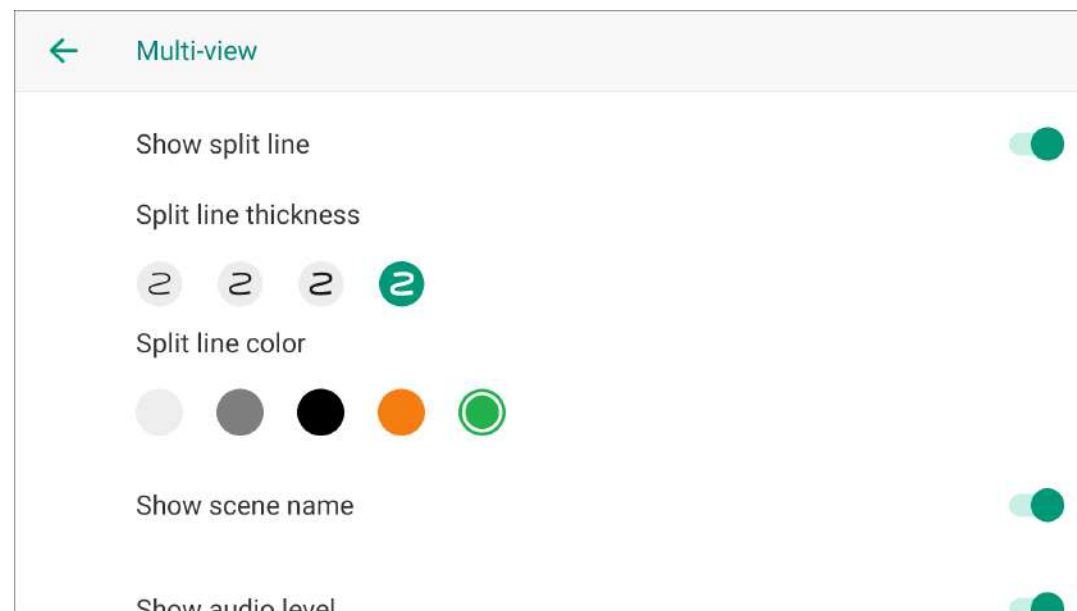

- **MTP mode:** this mode is use for connecting to a computer for file transfer, referring to [How to transfer files with computer via MTP mode](#) .

When you switch UVC/UAC mode to/from MTP mode, the device needs to be restarted to take effect.

- **UVC/UAC name:** tap to change the name for other software recognizing Director device.
- **Advanced UVC settings:** tap and then respectively set preferred parameters for UVC format, resolution and frame rate.

### Set Multi-view

You can tap  on right side of **Multi-view** for more settings.

- **Show split line:** toggle on/off the switch to show or hide split lines.
- **Split line thickness:** select your preferred thickness for split lines.
- **Split line color:** select your preferred color for split lines.
- **Show scene name:** toggle on/off the switch to show or hide scene names.
- **Show audio level:** toggle on/off the switch to show or hide audio level.
- **Show Preview/Program text:** toggle on/off the switch to show or hide Preview/Program text.

On the external screen connected to the USB-C port of Director Mini, you can see 8 video boxes at the bottom, displaying the scene thumbnails, and two larger boxes at the top, with the left one showing Preview view and the right one showing Program view.

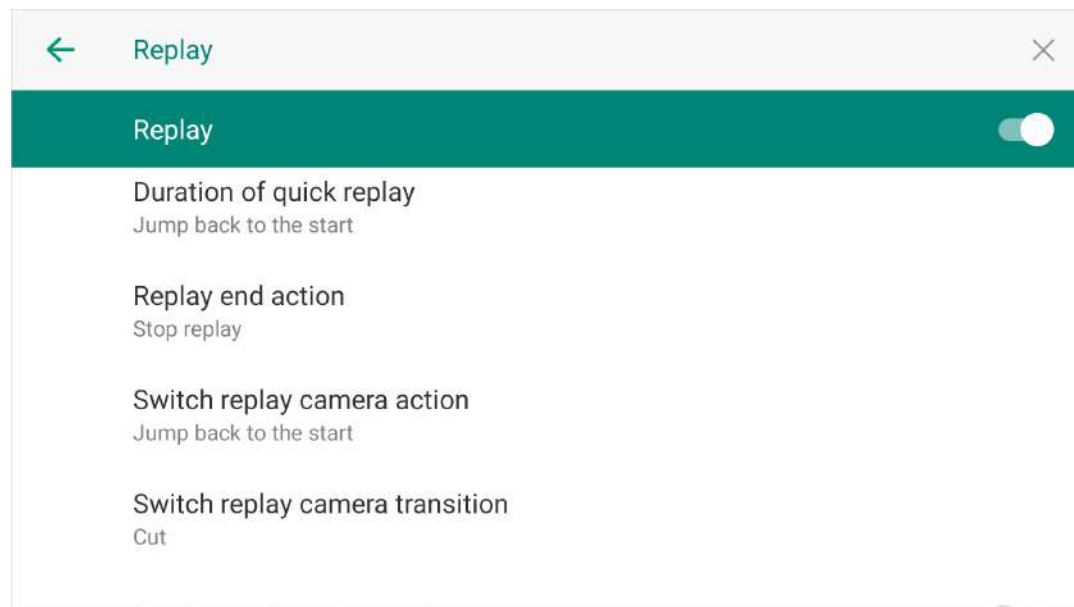
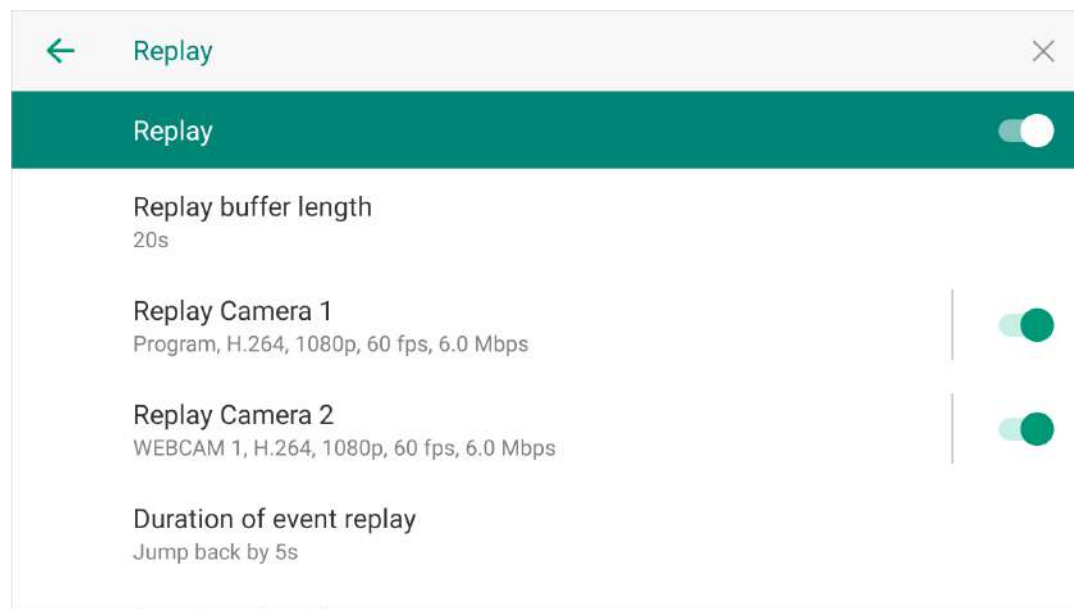

## Replay

Replay allows you capture some of greatest moments, slow down the action and save your highlights.

Toggle on the switch to enable the function, and then set the following items.

- **Replay buffer length:** tap and drag the slider to set the buffer length for relay, ranging from 3s to 60s.
- **Replay Camera 1/2:**
  - Tap the Replay Camera 1/2 to select the content to replay. By default, Camera 1 use the content of Encode 1, and Camera 2 use the content of Encode 2. You can also select NDI/RTMP/SRT/RTSP/Phone Camera sources for replay.
  - Toggle on/off the switches to set one-channel or two-channel replay. At least one camera should be toggled on.

Replay does not support NDI High Bandwidth source.

- **Duration of event replay:** You can choose a fixed duration, or select "Ask me when setting" to manually choose the duration when setting an event.
- **Duration of quick replay:** You can choose a fixed duration, or select "Ask me when replay starts" to manually choose the duration when your start quick replay.
- **Replay end action:** tap to select the end action.
  - Loop replay: it keeps playing repeatedly.
  - Show last frame: it stops replay and shows the last frame.
  - Stop replay: it stops replay and goes back to the program view. (Default)
- **Switch replay camera action:** define where the video of the target camera

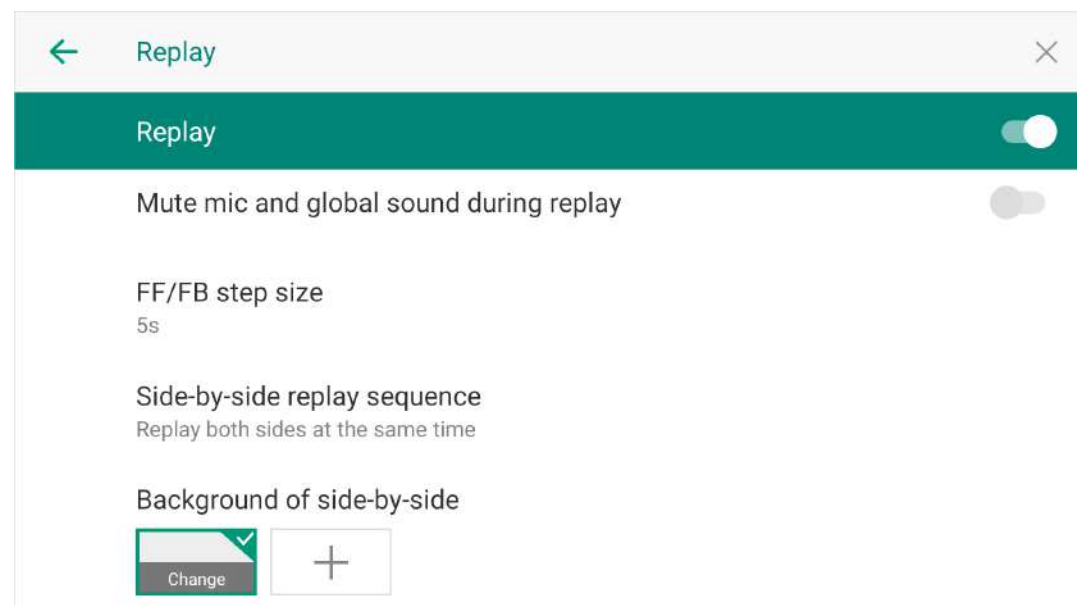
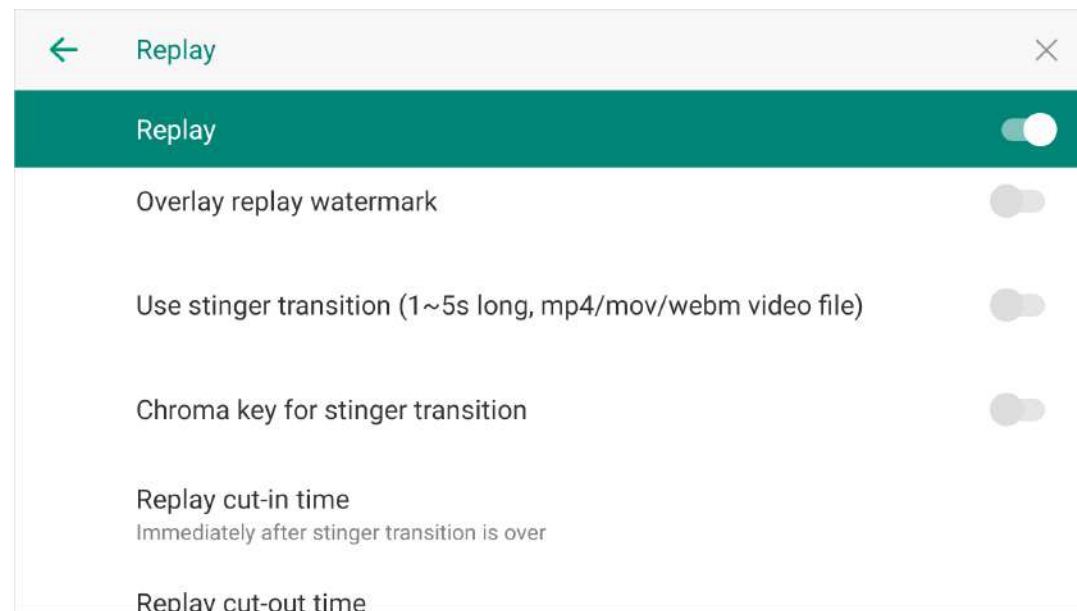

will start playing if you switch from one camera to another.

- **Switch replay camera transition:** define the transition effect if you switch from one camera to another. You can choose Cut or Fade, and set duration for Fade.
- **Overlay replay watermark:** toggle on/off the switch to show or hide the replay watermark during the replay. You can select the default watermark or upload a picture by tapping "+". And you can tap the thumbnail again to change it. Supported format includes PNG, JPEG and BMP.

The watermark is aligned with the upper right corner. Please customize your watermark with a proper size.

- **Use stinger transition:** when toggled on, the stinger transition will be added to the start and end of the replay. You can select the default video or upload a video clip by tapping "+". And you can tap the thumbnail to change it. Supported video format is MP4, MOV or WebM, with a length of 1 to 5 seconds.
- **Chroma key for stinger transition:** toggle on/off the switch to enable or disable the chroma key for stinger transition. And you can set similarity, smoothness and spill.
- **Replay cut-in time:** Set the time for the replay to begin.
- **Replay cut-out time:** Set the time for the replay to stop.
- **Mute mic and global sound during replay:** toggle on/off the switch to mute or unmute the microphone and global sound during replay.
- **FF/FB step size:** tap to select the step size for fast forward and fast backward during replay.
- **Side-by-side replay sequence:** tap to select the preferred sequence.

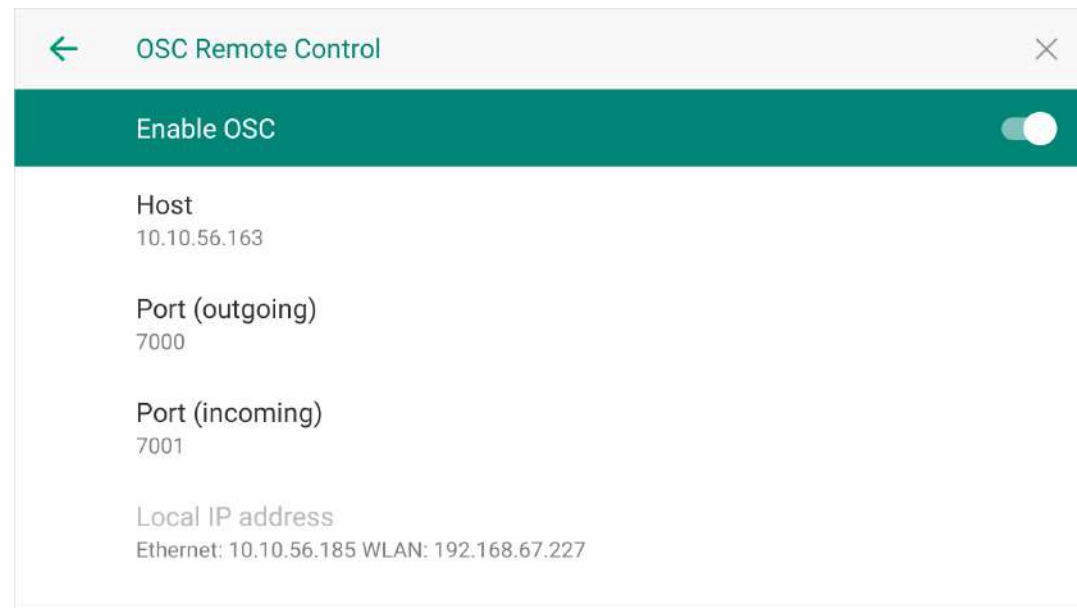

- **Background of side-by-side:** select a color or picture as the background of the side-by-side layout. You can tap + to upload a picture. Supported format includes PNG, JPEG and BMP.

As Replay will continuously consume some resource, it is suggested to disable it if you do not need this function.

## OSC Remote Control

Director device incorporates the Open Sound Control (OSC) protocol, enabling you to operate the device effortlessly via the OSC protocol.

The user datagram protocol (UDP) is used by the device for communication with OSC enabled applications.

Director device is compatible with multiple OSC enabled apps, such as TouchOSC. We provide a sample layout program for TouchOSC, which helps you start using OSC control quickly and easily.

The following sections introduce how to use OSC based on the TouchOSC app.

### Enable OSC

1. Toggle on the switch of **Enable OSC**.
2. Tap **Host** to enter the IP address of the device on which TouchOSC is installed. This IP address enables the Director device to know the location of TouchOSC, so that it can accurately send synchronization and other messages to TouchOSC when needed. (In this case, TouchOSC acts as the receiver, though its main function is to send control commands.)
3. Tap **Port (outgoing)** to enter the port number. This number can be entered as the "Receive Port" in the TouchOSC app to receive synchronization messages sent by the Director device. (In the

synchronization scenario, TouchOSC acts as the receiver.)

4. Tap **Port (incoming)** to the port number. This number can be entered as the "Send Port" in the TouchOSC app, serving as the destination for the app to send control messages to the Director device. (At this time, TouchOSC acts as the sender.)
5. View **Local IP address** to get relative IP address information. It can be entered in the TouchOSC app for sending message to Director device.
6. Connect your TouchOSC app with the device based on the above information, and then start controlling the device.

You can visit [Director OSC](#) for more details about OSC addresses and arguments and downloading the Director OSC Sample Layout file developed for TouchOSC.



## Use TouchOSC

The following introduces how to connect the TouchOSC app with Director device and get to start use the sample layout.

1. Go to [TouchOSC](#) to download the TouchOSC app.
2. Open TouchOSC, click the chain link button on the toolbar to open the Connections configuration window.
3. Switch to the OSC tab page, enable the checkbox next to Connection 1, select UDP from the drop-down box, and enter the following information.
  - **Host:** The IP address of Director device. This allows TouchOSC to identify which device to send OSC messages to. The Director device uses this address to receive messages from TouchOSC.
  - **Send Port:** The Port (incoming) you've set on Director device. The

Director device listens on this port to receive control commands and other messages sent by TouchOSC.

- **Receive Port:** The Port (outgoing) you've set on Director device. It is used for the Director device to send synchronization and other feedback messages to TouchOSC. TouchOSC receives these messages through this port, ensuring the interactivity of the communication between the two.
4. Click **File > Open...**, and open the [Director OSC Sample Layout](#) file.
  5. Click the play button on the toolbar to switch to control surface view.
  6. Start to control Director device via the control surface.

For more information about how to use TouchOSC, please go to [TouchOSC](#).

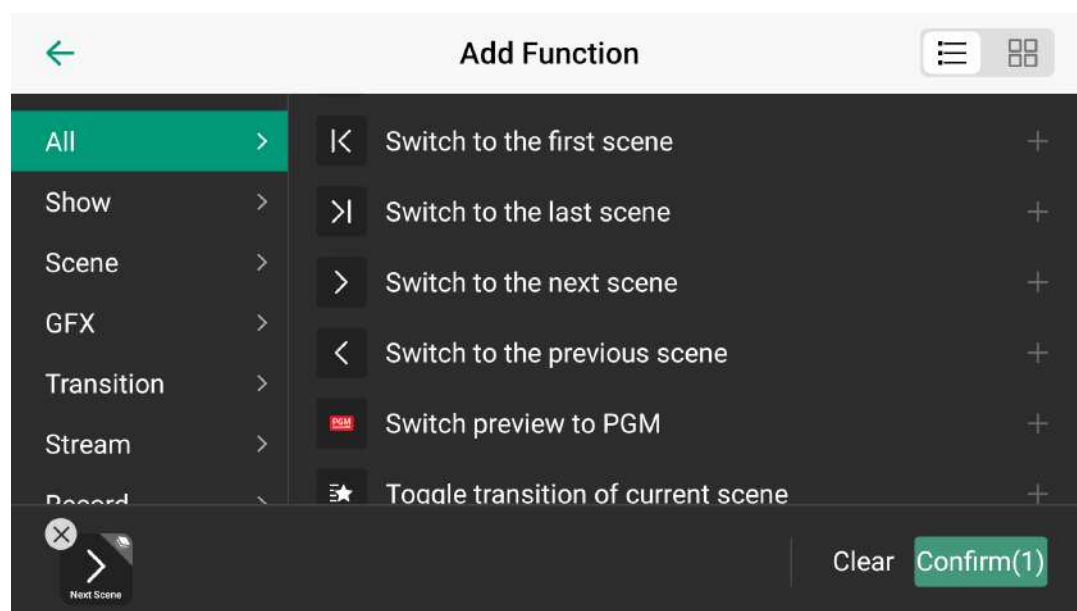
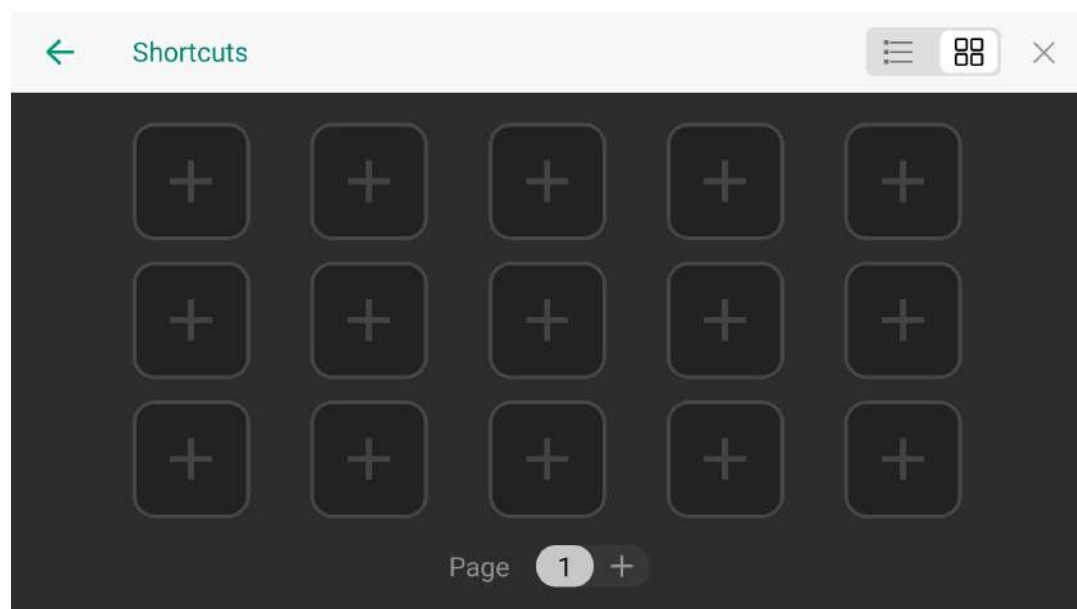

## Shortcuts

Director device supports the MiraBox Stream Dock 293 for plug-and-play control. Just add your desired shortcuts to this page, no need to assign key binds. Once set up, simply connect your MiraBox Stream Dock to the Director device, all shortcut icons and layout are synchronized to the Stream Dock, and you can use it for instant control.

You can also connect a common USB or Bluetooth keyboard, such as X-Keys and NumberPad, and create Shortcuts to control the device more easily.

### Add Shortcuts

1. Tap .
2. Add a function:
  - i. Select a function category from the list on the left side, and then choose a function on the right side. For some functions, additional selections or operations are required; please follow the on-screen prompts to proceed. Tap the buttons in the upper right corner to switch between list mode and thumbnail mode.
    - You can add multiple functions for one shortcut.
    - The extra "Wait" function can be added between each two functions. By setting the wait duration, a group of functions can be activated sequentially with a single press, allowing them to take effect one by one.
    - The "Next page", "Previous page" and "Go to page N" functions can help you turn pages on the MiraBox Stream Dock.
  - ii. A list of selected function icons is displayed at the bottom. You can long-press an icon to drag and reorder it, and tap "X" to delete it.

Cancel Add Shortcuts Save

Name  
Next Scene A A A

Function  
Next Scene 

Background

Key (Optional)  
Assign a key from a USB or Bluetooth keyboard to the shortcut + Add

Cancel Find a Key Add

ⓘ Attach a USB keyboard or a Bluetooth keyboard to the device and use it to execute shortcut functions.

Key Code: 145+123  
Press a key on the keyboard to help find key code.

Key Text: 1  
Enter the text on the key to help identify the key.

To remove all the functions, tap **Clear**.

iii. After completing the function addition, tap **Confirm**.

You can see the added function in the "Function" area, and you can tap the icon to modify the function.

3. (Optional) Tap **Name** to enter a custom name for your shortcut. Tap "A" at the right side to change the font size.
4. (Optional) Set a solid or gradient background color for the shortcut icon.
5. (Optional) For a common keyboard, such as X-keys or NumberPad, connect it to the device, then tap **+ Add** on the right side of "Key":
  - i. Press a key on the keyboard to find the key code, or you can enter a key code number. You can also press two or more keys at the same time.
  - ii. Enter the key text on the key to help identify the key. You can also customize the text.
  - iii. Tap **Add** to confirm.
6. Tap **Save** in the upper right corner to finish adding this shortcut.
7. Repeat steps above to add more shortcuts.

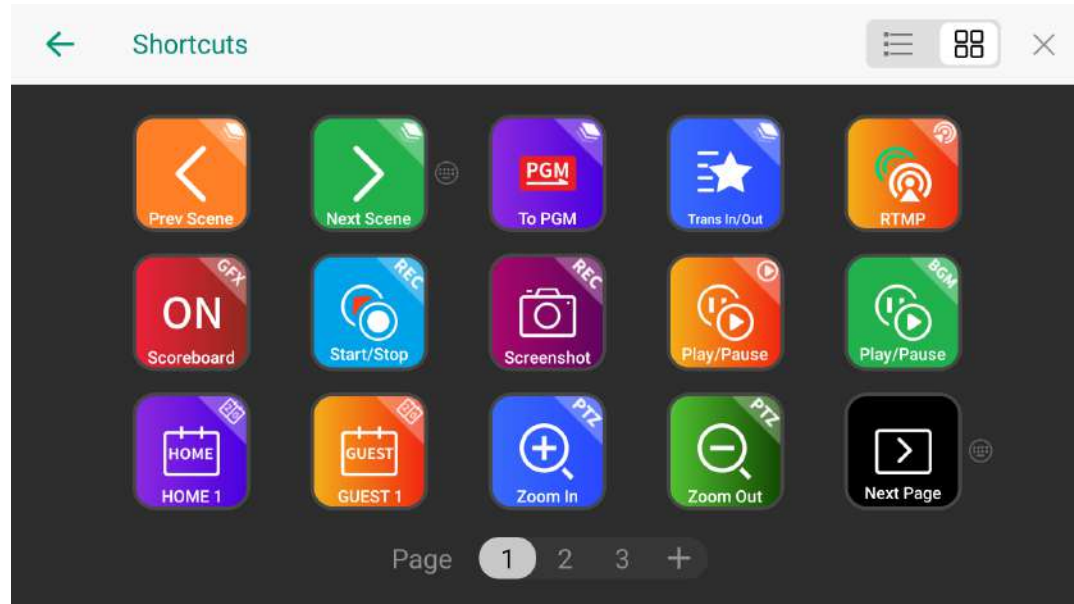

## Shortcut List

The shortcut list displays all the added shortcuts. You can manage the shortcuts as follows:

- Long-press and drag an icon to reorder it.
- Long-press an icon and tap **Edit** in the pop-up menu to edit the shortcut.
- Long-press an icon and tap **Delete** in the pop-up menu to delete the shortcut.
- Tap the page number at the bottom to switch pages.
- Tap the "+" at the bottom to add more pages.
- Long-press a page number and then tap **Delete** to delete the page and all shortcuts on it.
- Tap the buttons in the upper right corner to switch between list mode and thumbnail mode.

For the full shortcut list, please refer to [Shortcuts for Director](#).

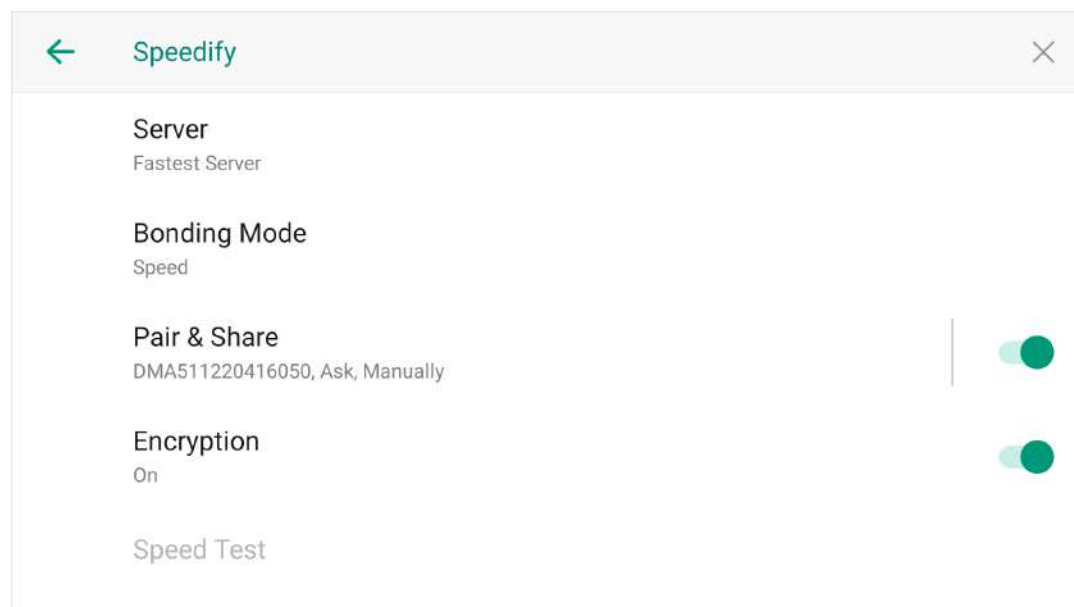
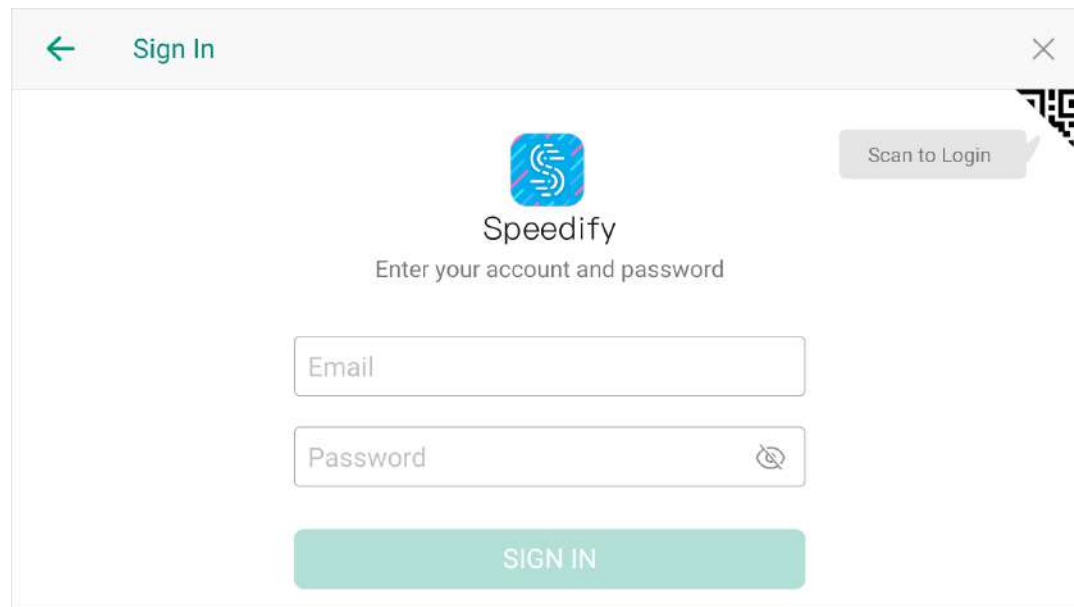

## Speedify

The embedded network bonding service provided by Speedify can use all available Internet connections to optimize live stream stability.

### Log In Your Account

To use your own account, tap **Sign In**. Then you can enter your account and password to sign in, or you can switch to the QR code page and then scan the QR code to log in.

If you do not have a Speedify account, you are optimized with 2 GB of data every month for free with a Free Account. The free 2 GB for each month does not roll over. Once the free monthly amount is reached, you can either wait until next month for another 2 GB of free data, or, if you want to keep using network bonding, you can go to [Speedify](#) to upgrade for unlimited usage.

### Set Network Bonding

Tap  behind **Network Bonding** to set the follows.

- **Server:** Select the server to use.
  - **Automatic Selection:** The device automatically connects to the best servers for performance.
  - **Fastest Server:** By default, the device picks the closest Speed Server, which will give you the fastest internet connection.
  - **Closest Dedicated Server:** It allows all of your clients, mobile and desktop, to use the closest private server that only members of your team can access. (Only for team account)
  - **Closest Public Server:** It allows all of your clients, mobile and desktop, to use the public server that only members of your team can access.

(Only for team account)

- **Torrent Friendly Server:** This connects you to a server that allows BitTorrent traffic. These servers are located in Amsterdam and, depending on your location, maybe significantly slower than closer servers.
- **Dedicated Servers:** Dedicated servers can be selected only if the login account is a team account. Country-specific, city-specific, and server-specific options are available. For more information about Dedicated Servers, please go to [What are Dedicated Speed Servers?](#)
- **Manual Selection:** You can select a Speed Server from a specific country.
  - **Choose a specific country:** Tap a circle on the right side to select a country.
  - **Choose a specific city:** Tap the arrow on the left side of a country to expand the list of cities, and then tap a circle on the right side to select a city.
  - **Choose a specific server:** Tap the arrow on the left side of a city to expand the list of available servers, and then tap a circle on the right side to select a server.
- **Bonding Mode:** Decide how your connections are used.
  - **Speed:** It intelligently distributes your web traffic among all available internet connections in order to deliver optimal speed and performance.
  - **Redundant:** It operates at the speed of the fastest single internet connection and use additional data in order to deliver an ultra-reliable connection. Each packet gets sent simultaneously over multiple connections and whichever packet gets through first, is the one to be delivered. Please note that this mode uses more data and more battery.

- **Enhance Streaming:** It maximizes the speed and reliability of your streaming traffic by intelligently using both bonding and redundant traffic to get the best performance from your available internet connections. It will prioritize your Streaming traffic over any other traffic, and will intelligently switch between active bonding and redundancy depending on what your connections need. Do keep in mind that this mode can use extra data and battery to help deliver a better streaming experience.  
(Default)
- **Pair & Share:** Toggle on the switch to easily share Cellular connections back and forth between multiple Speedify users on the same Wi-Fi network.
  - **Display Name:** This is the name that other people running Speedify with Pair & Share will see when they scan for devices to pair with.
  - **Pairing Requests:** The behavior when someone attempts to Pair with your device. There are three options:
    - **Ask (Default):** Every time a device attempts to pair for the first time, ask you if you wish to accept.
    - **Automatically Accept:** Always allow any pairing attempts.
    - **Ignore:** Do not respond to pairing requests. You will not be notified and the other devices will not be able to share or receive from your device.
  - **Pair My Devices:** Controls whether or not Speedify should automatically pair the device with other devices on your account that are also on the same local network.
- **Encryption:** Optional. When enabled, it utilizes the latest encryption standards to keep your information private with minimal impact to overall

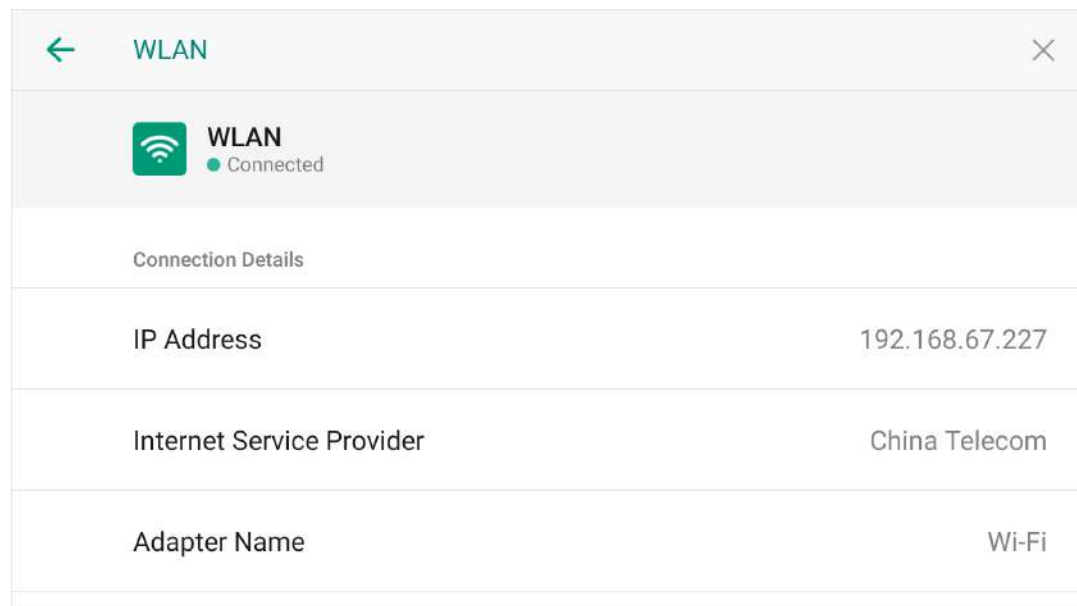

performance.

- **Speed Test:** Optional. Tap to test your individual and combined connection speeds. It shows the download and upload speeds of each connection. Be aware that this feature uses a lot of data, so you may want to run it sparingly if you have a limited data plan or if you are using a free Speedify Plan.

The Speed Test feature is only available after you have enabled Network Bonding and connected the server successfully.

- **Generate Logs:** If you encounter any problem, you can tap it to export logs to the SD card or USB drive, and then send the logs to our support team.

## Manage Connections

On the Speedify page, tap each network to manage the connection.

- **Connection Status:**
  - **Connected:** The connection is working, and Speedify is using it.
  - **Disconnected:** The connection cannot access the internet, so Speedify is not using it.
- **Connection Details:**
  - **IP Addresses:** The IP address of this connection.
  - **Internet Service Provider:** The information of the Internet service provider.
  - **Adapter Name:** The name of the adapter.
  - **Adapter Description:** The description of the adapter.

- **Priority:** The priority level of a connection determines how and when Speedify should use it.
  - **Automatic (Recommended):** Let Speedify manage the connection's priority.
  - **Primary:** Always use this connection.
  - **Secondary:** Use this connection for speed boosts and failover, but less than Primary.
  - **Backup:** Only use this connection for failover when no others are available. Does not do bonding for speed (least used).
  - **Never:** Don't use this connection.

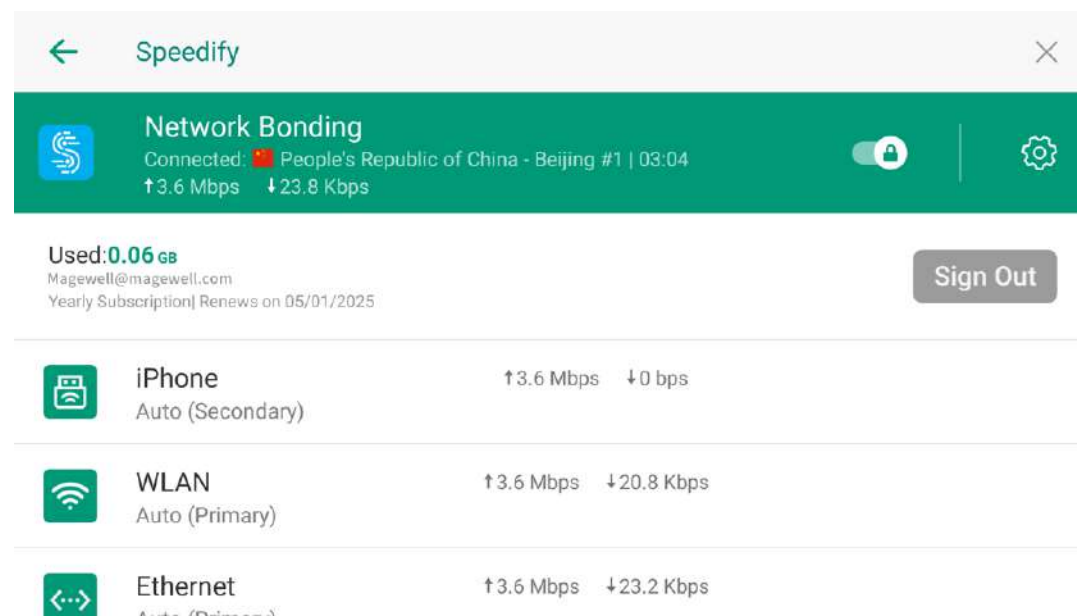

## Enable Network Bonding

On the Speedify page, toggle on the switch of **Network Bonding**, and it starts connecting the server.

When connected, it displays the server name, the time used, the total upload and download speeds. If a lock icon appears, it indicates the connection is encrypted.

In the account area, it displays the data usage and the account information. The upload and download speeds of each network are displayed underneath.

To stop network bonding, toggle off the switch.

You can also enable network bonding and view connection speed on the Control Center.



## System

Tap **System** on the settings page to set the system related items.

## Language

1. Tap **Language** in the system page.
2. Tap a language.
3. Tap **Continue**. The device will restart and change to the selected language.

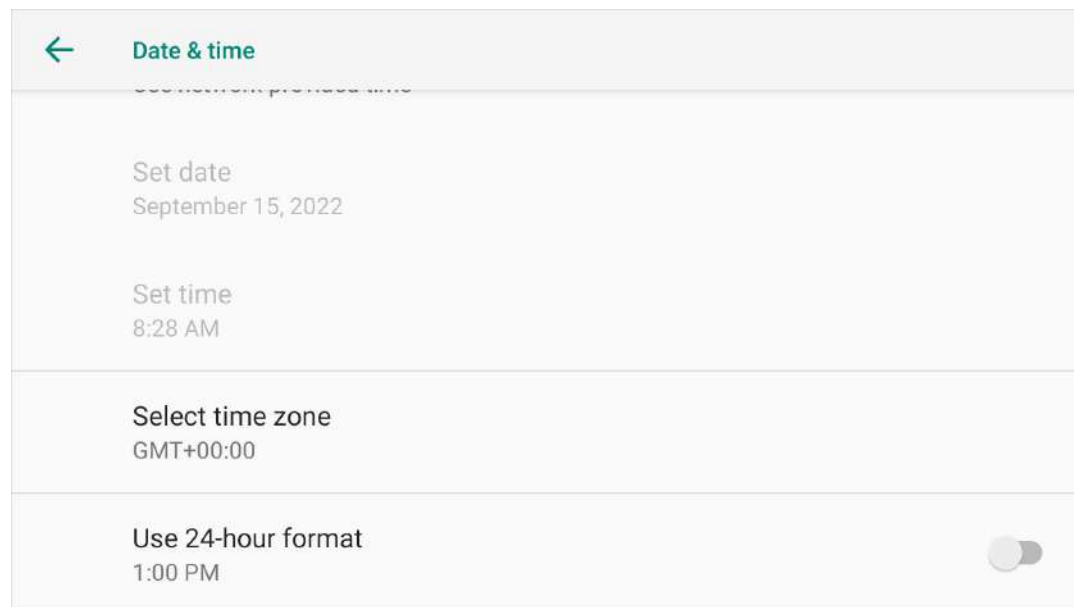
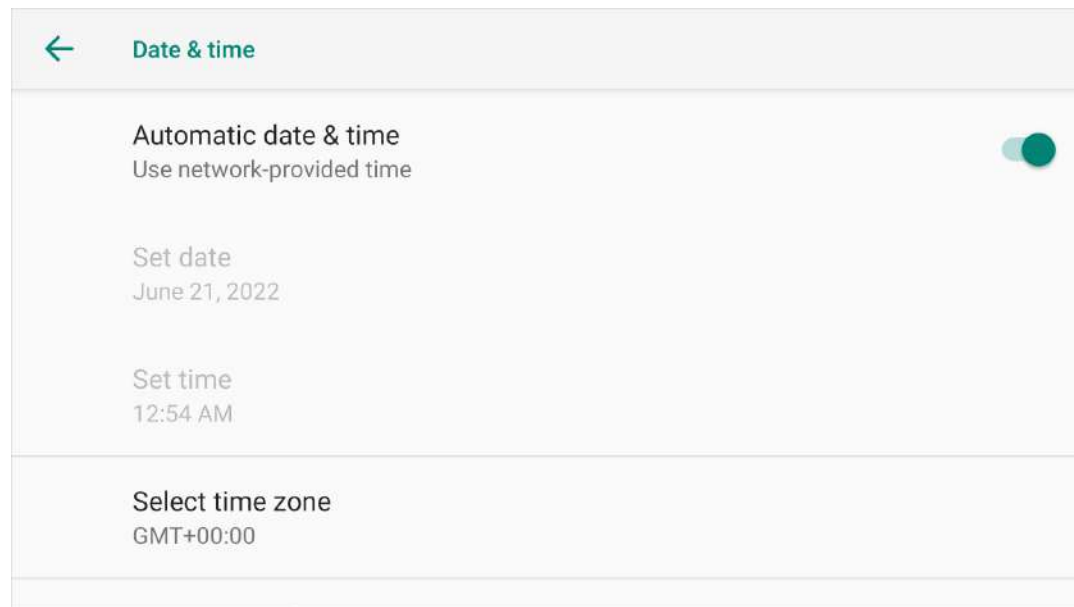

## Date and Time

By default, your device receives date and time information from the network. Tap **Date & Time** in the system page, and then you can set manually.

- **Automatic date and time:** Use the date and time provided by the network. When it is disabled, you can set date and time respectively.
- **Select time zone:** Tap it to select time zone by region, or tap  at the upper right corner to select by UTC offset.
- **Use 24-hour format:** Use 12-hour format by default. You can turn it on to switch to 24-hour format.

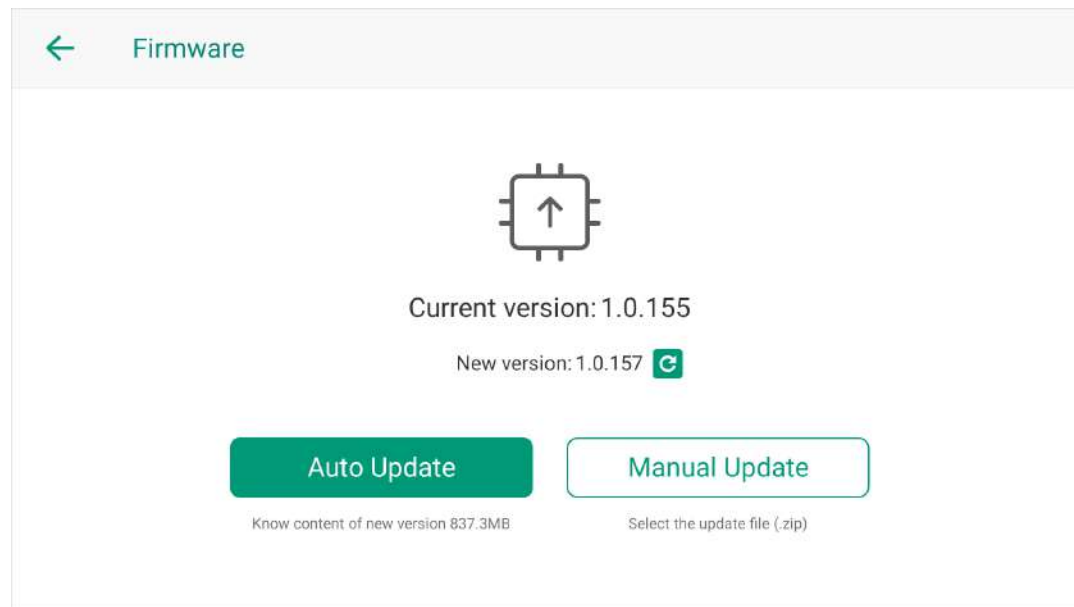

## Update Firmware

Director device supports automatically and manually updating firmware. Manual update can update to any firmware version, while auto update can only update to the online latest version.

### Auto Update

1. Ensure your device is connected with network.
2. Tap **Firmware** on the system page.
3. Check the information of current version and new version. You can tap the  button to refresh the information of new version.
4. If a new version is available, tap **Auto Update**. The size of the update file will be displayed under the button.
5. Read the release notes of the new version on the popup to decide whether to update to this version.
6. Tap **Update**. The device starts downloading the update file and implementing update automatically. Please wait and do not exit.

 During the upgrade process, do not power off or restart your device. This may cause irreversible damage to your device.

7. When the firmware update is completed, tap the **Reboot** button to restart your Director device.

If it accidentally exits or the network is disconnected during update file downloading, Director device supports resuming from the break point.

## Manual Update

Please download the firmware update file on [Magewell official website](#), and then follow the steps below to update your Director device.

1. Import the update file to the internal storage of the device, or import it to an SD card / USB flash driver, and insert the SD card or USB flash driver to the device.
2. Tap **Firmware** on the system page to enter the Firmware page which displays the information of current version and new version.
3. Tap **Manual Update**, and then select the update file.
4. Director device will then upgrade automatically. Please wait and do not exit.

 During the upgrade process, do not power off or restart your device. This may cause irreversible damage to your device.

5. When the firmware update is completed, tap the **Reboot** button to restart your Director device.

If the firmware update fails, refer to [What to do when firmware update fails](#).

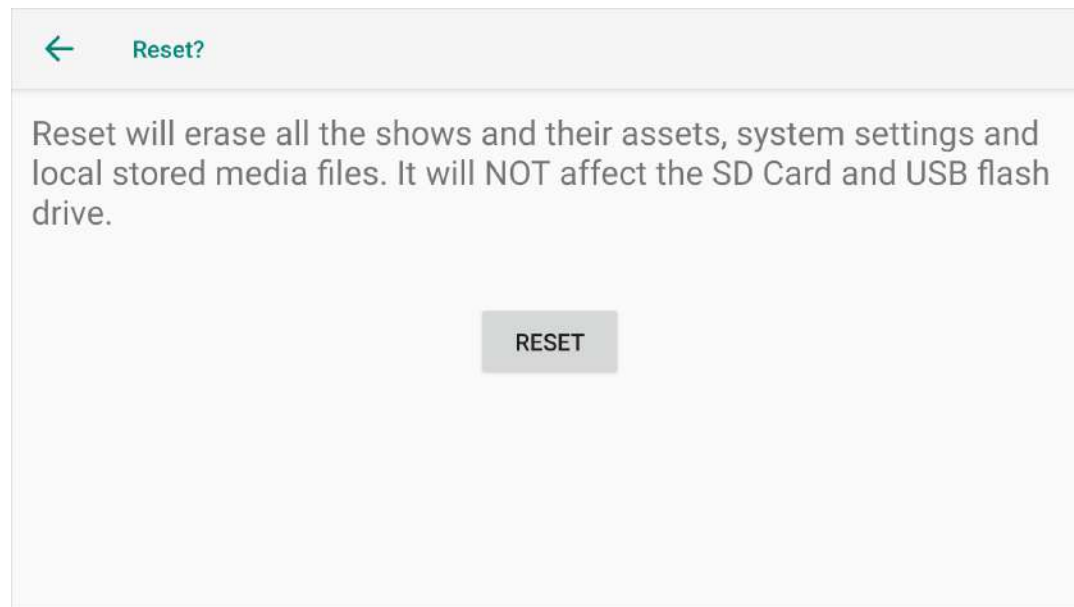

## Reset

⚠ This function is going to reset the device. Before resetting, make sure that you have backed up all the files you need.

1. Tap **Reset** in the system page.
2. Tap the **Reset** button. The device will be rebooted with all the shows and their assets, system settings and local stored media files being deleted.

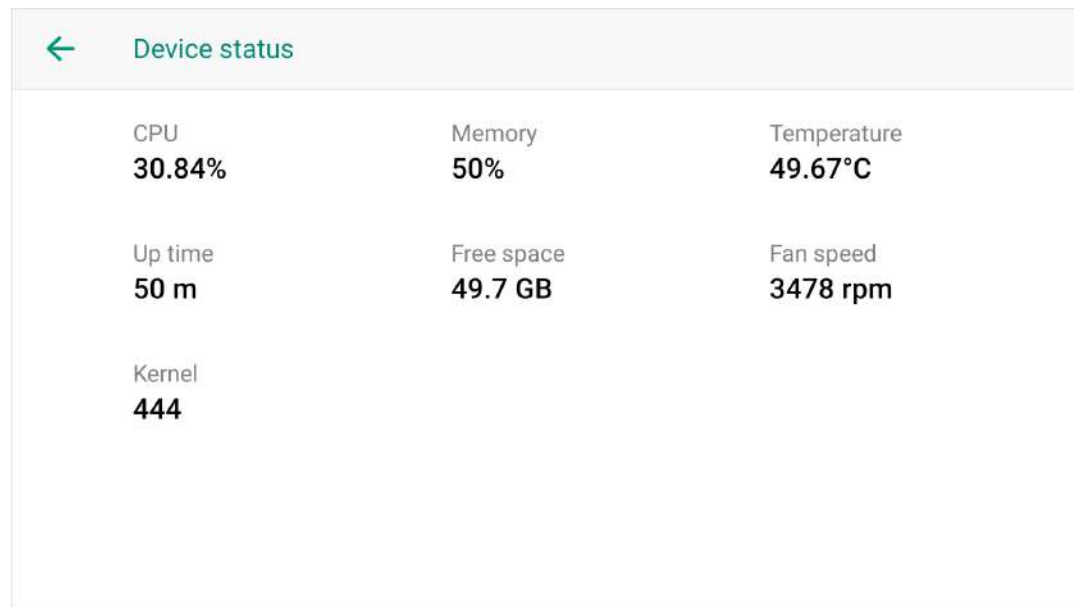

The screenshot shows a 'Device status' page with a back arrow and the title 'Device status'. The page displays several system metrics in a grid-like format:

CPU <b>30.84%</b>	Memory <b>50%</b>	Temperature <b>49.67°C</b>
Up time <b>50 m</b>	Free space <b>49.7 GB</b>	Fan speed <b>3478 rpm</b>
Kernel <b>444</b>		

## Device Status

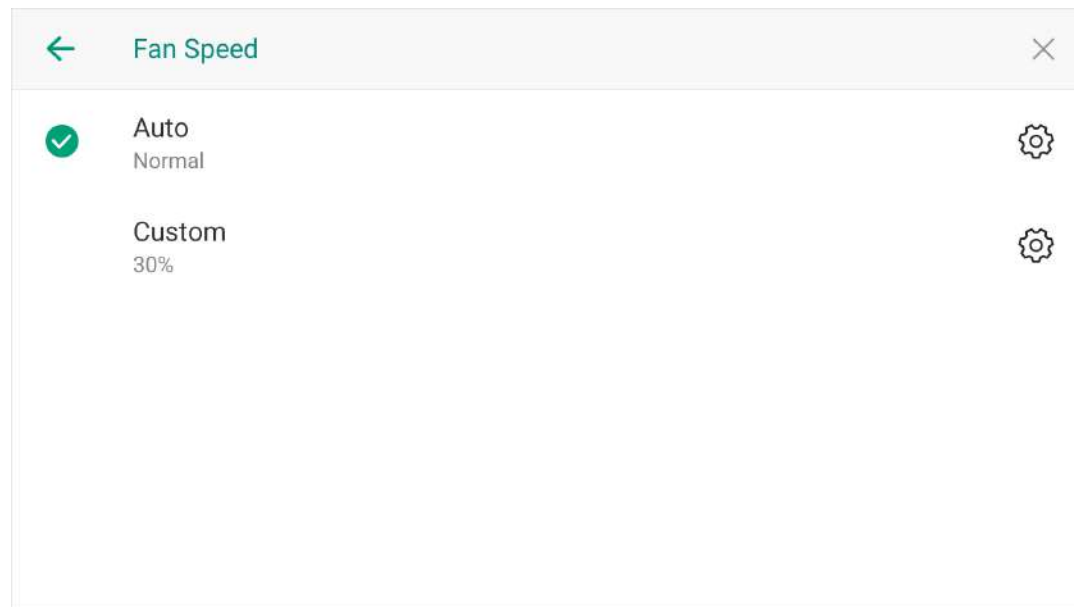

Tap **Device status** in the System page, and it shows the running status of the device.

- **CPU:** the CPU usage of Director device, in percentage.
- **Memory:** the memory usage of Director device, in percentage.
- **Temperature:** the temperature of the chipset on Director device. To avoid overheat, ensure that device is working in a well-aired environment with proper temperature. When the temperature approaches 90 degrees, you need to reduce the temperature, such as by using a fan.
- **Up time:** the duration that Director device keeps running since last startup.
- **Free space:** the available storage of Director device.
- **Fan speed:** the rotation speed of the fan per minute, which changes based on the temperature of Director device.
- **Kernel:** the usage of kernel resource.



## Fan Speed

You can configure the fan speed, with options for automatic adjustment and custom speed settings.

- **Auto:** The fan speed is automatically adjusted by the system. You can tap  to access sub-options:
  - **Silent:** Sets the fan to run at the lowest speed for minimal noise.
  - **Normal:** Balances cooling performance and noise.
  - **Maximum:** Maximizes fan speed for the best cooling effect, with higher noise.
- **Custom:** Manually set the fan speed. Tap  and then drag the slider to adjust the speed percentage.

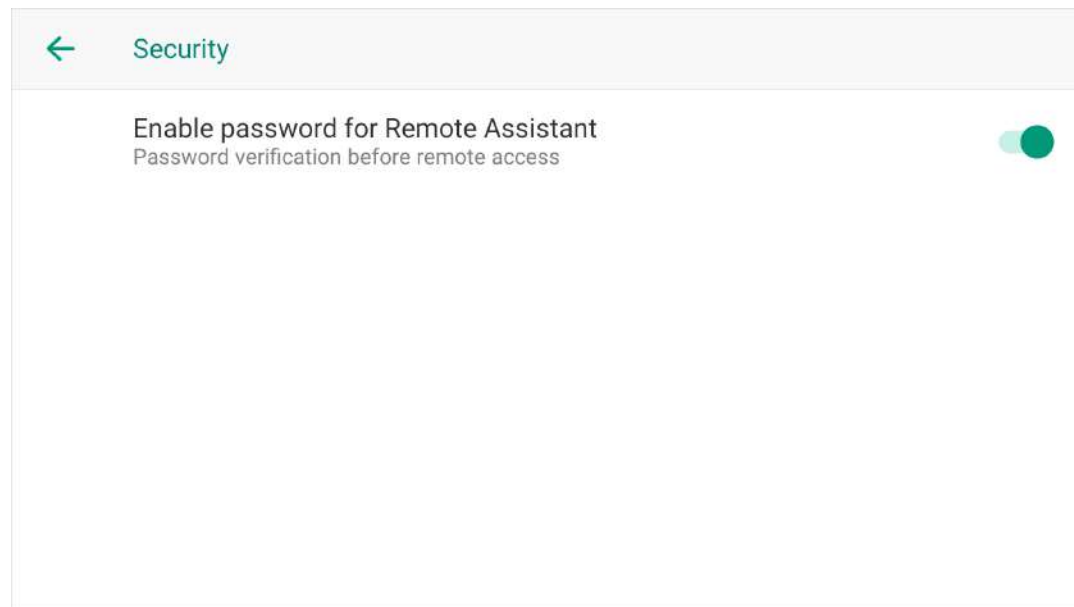

## Security

You can enable password to enhance the security of using Director Utility app to control the device.

1. Turn on the switch of "Enable password for Remote Assistant".
2. Set your password in the popup. The password must be between 1 to 32 characters long, and can only contain letters and numbers.
3. To disable password, turn off the switch. And when you enable it again, you need to reset the password.

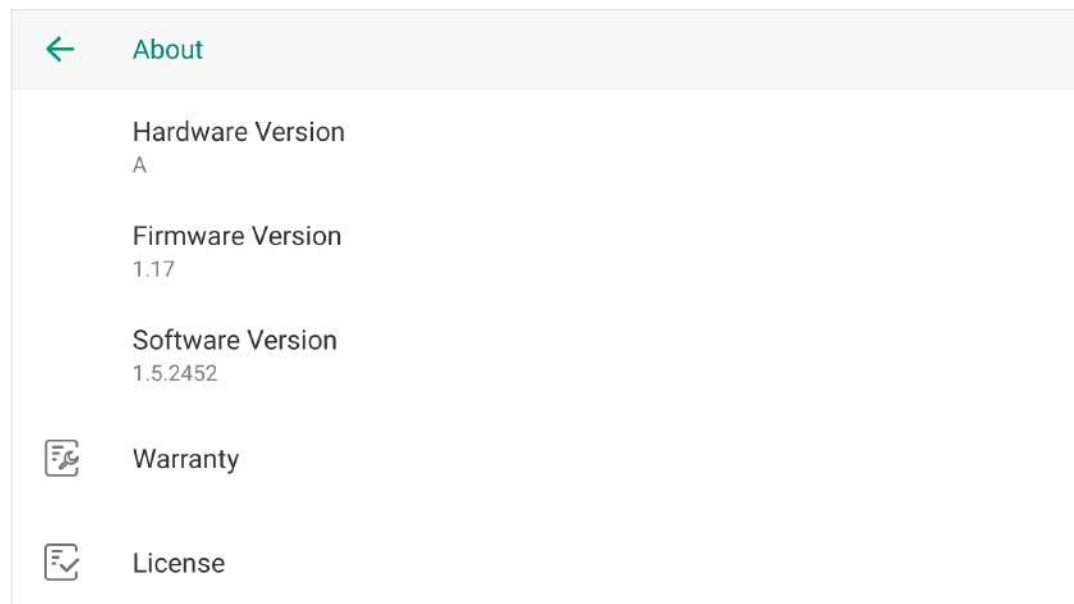
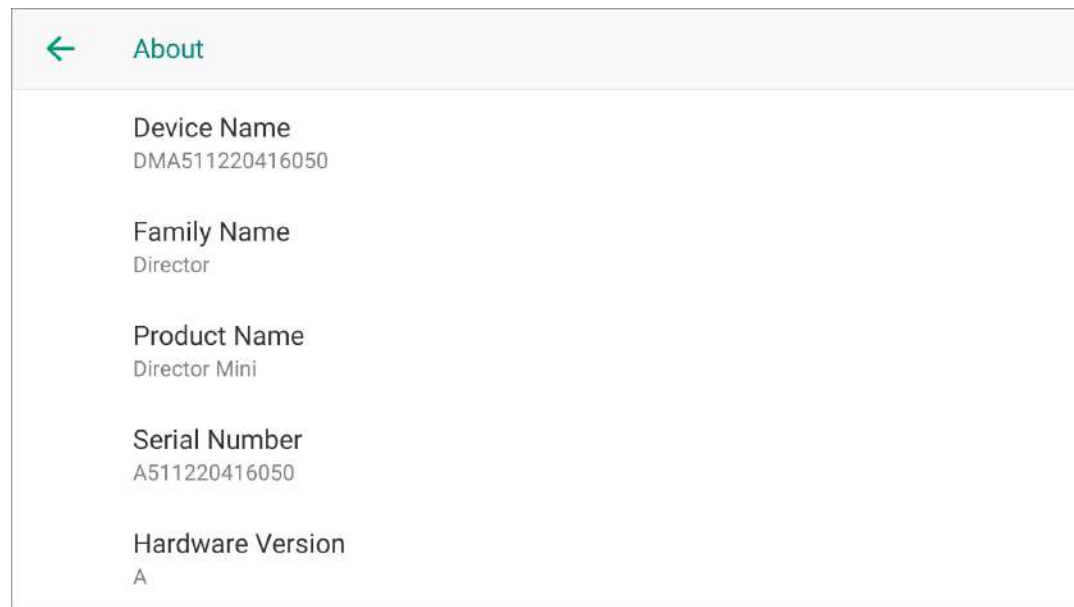

## About

Tap **About** in the system page, and it shows the information of the device, including its device name, family name, product name, serial number, hardware version, firmware version, software version, warranty, and license.

### Rename the device

You can rename the device.

1. Tap **Device Name**, and enter a new name.
2. Tap **Save**

# Battery

Director device supports two hot-swappable NP-F battery packs, which allows for device operation without the need for a physical power connection. You can insert battery and power adapter separately or simultaneously. When they are both inserted, Director device uses the power supplied by the power adapter as the priority.

## Caution

If the battery pack is mishandled, the battery pack can burst, cause a fire or even chemical burns. Please read the following cautions before installing batteries.

- Do not disassemble the battery pack.
- Do not crush and do not expose the battery pack to any shock or force such as hammering, dropping or stepping on it.
- Do not short circuit and do not allow metal objects to come into contact with the battery terminals.
- Do not expose to high temperature above 60°C (140°F) such as in direct sunlight or in a car parked in the sun.
- Do not incinerate or dispose of in fire.
- Do not use damaged or leaking batteries.
- Be sure to charge the battery pack with a qualified charger.
- Keep the battery pack out of the reach of children.
- Keep the battery pack dry.

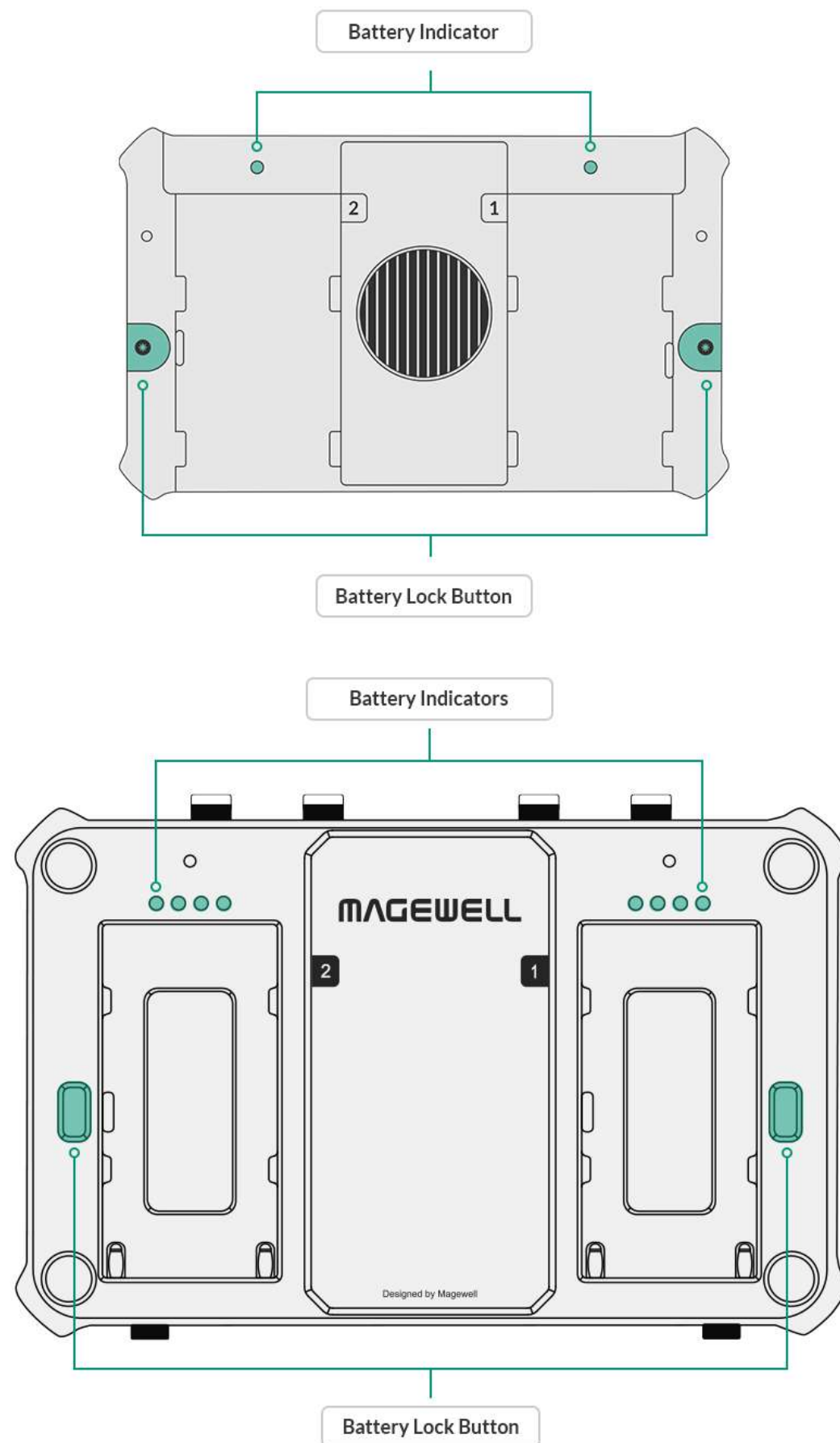

## Battery Installation

Director device supports 7.4V NP-F type battery packs, such as Sony NP-F550 and Sony NP-F750. You can use the same or equivalent types.

- **Install:** press the lock button first and put the battery into the slots until it is locked in the correct position.
- **Remove:** press the lock button first and remove the battery.

## Battery Indicator

### Director Mini

Power on the device. On the back of the device, the battery indicator corresponds to the battery lights up. The indicator has three colors to indicate the battery percentage.

- **Green:** 50% - 100%
- **Orange:** 25% - 50%
- **Red:** <25%

### Director One

Power on the device. On the back of the device, the battery indicators correspond to the battery light up. The indicators indicate the battery percentage by following ways.



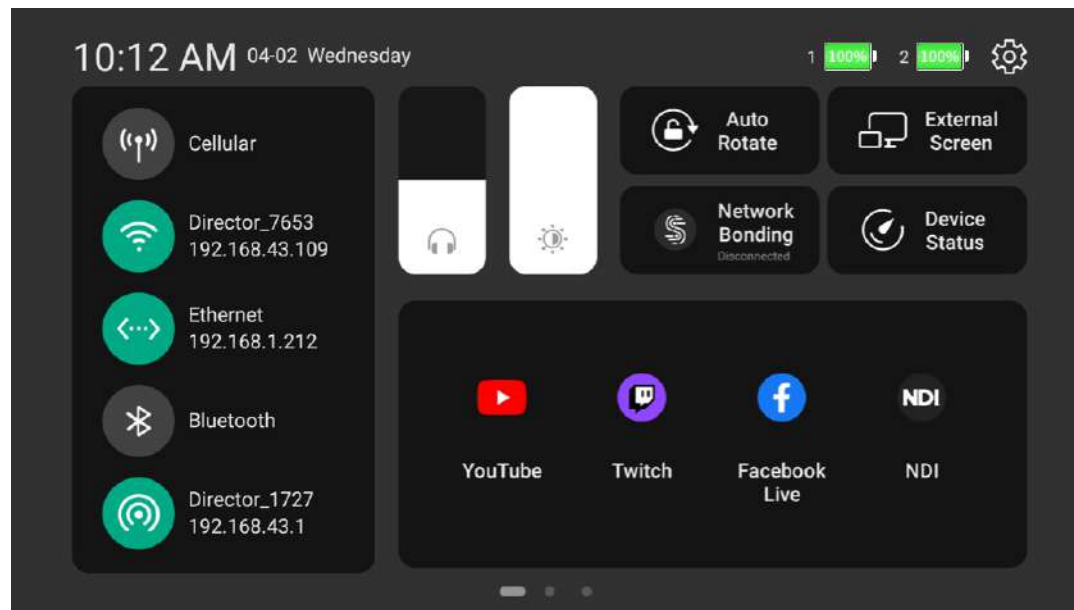

- ● ● ● ● : 75% - 100%
- ● ● ● ● : 50% - 75%
- ● ● ● ● : 25% - 50%
- ● ● ● ● : <25%

When the battery is depleted, the corresponding indicators light off.



## Battery Status

On the screen, you can also see the battery status icon on the status bar. When there are two batteries installed, it shows the two battery status icons.

-  : 75% - 100%.
-  : 50% - 75%
-  : 25% - 50%
-  : < 25%

You can also check battery status on the Control Center by swiping down from the top of the screen.

If the power adapter is also connected, the device uses power adapter in priority and it does not show the battery status icon.

During operation, your Director Mini will use the battery 1 first. When battery 1 is depleted, it will swap over to battery 2 without interruption. As for Director One, it will preferentially use the battery with a higher charge. If the two batteries have the same charge level, they will supply power to the device simultaneously.

As Director device supports hot swapping, you can replace the battery without any interruption to your show.

## Typical Battery Working Time

The following is what you can expect for a single battery.

\* Based on ideal conditions.

### Director Mini

Capacity	Working Condition	Working Hours
7800mAh	Displaying, streaming and recording a multi-view scene consisting of HDMI, Video and WEBCAM sources	3 hours 30 minutes
2200mAh	Displaying and streaming an HDMI scene	2 hours 20 minutes

### Director One

Capacity	Working Condition	Working Hours
7270mAh	Displaying, streaming and recording a multi-view scene consisting of HDMI, Video and WEBCAM sources	2 hours 40 minutes
4400mAh	Displaying, streaming and recording a multi-view scene consisting of HDMI, Video and WEBCAM sources	2 hours

# FAQs

## General

### Notice for connecting the USB-C OUT port to the computer

1. Please connect the device with power cable or battery and power on at first, and then connect to the computer.
2. To power off the device, disconnect the USB-C OUT port from the computer at first, and then press the power button to power off.
3. When the USB-C OUT port is connected to the computer, after creating a file to the internal storage on the device, such as long-pressing the power button to take a screenshot or recording a video, the computer may not recognize the file just created or a pop-up window prompts that the device is not available, you need to reconnect the USB-C OUT port.

### How to create a show?

1. Tap  > **Create a show**.
2. Enter your show name, select the show's frame rate and choose the screen orientation.
3. Tap **Create**.

### How to create a new scene?



1. Tap  on the main screen.
2. In the **Create New Scene** window, select a source that you want to put into the new scene.
3. Edit the scene in the Scene Editor.
4. Save the changes you have made in the Scene Editor, and then the thumbnail of the new scene will be added to the end of the Scene List.

## How to edit a scene?

1. Long press a thumbnail in the scene list on the main screen.
2. Tap **Edit** to open the Scene Editor.
3. You can add more sources, resize the source, add transition effects, etc. For details, please refer to [Edit Scenes](#).

## How to configure live stream servers?

Configure the stream server on the device:

1. Tap  > Settings > Stream, and select a sever to enter the configuration page.
2. Or tap  on the main screen, tap a server not configured to enter the configuration page.

Only when you have not configured Quick Stream for any server, you can tap  to configure a server; otherwise, it will start streaming.

3. Configure the server according to the introductions on the page. For details, please refer to [Configure Streaming Server](#).

## How to start and stop live streaming?

### Manual Stream



1. Start streaming:
  - a. Tap  on the main screen.
  - b. Tap **Connect** next to a configured server in the **Live Stream** window.
  - c. (Optional) Repeat the above steps to stream to another server at the same time.

The maximum number of servers you can simultaneously connect to is four. This limit is set to ensure stream performance. When the NDI streaming is on going, you cannot stream to other server. Vice versa. If you have not configured any other server, you cannot stream to another server. During the live streaming, the Configure or Log in button of the unconfigured server is unavailable.

2. Stop streaming:
  - a. Tap  on the main screen.
  - b. In the Live Stream window, tap **Disconnect** of a working server to stop streaming to the server.
  - c. (Optional) Repeat the above steps to stop streaming to the other server.

### Quick Stream

If you have turned on **Quick Stream** when you [Configure Streaming Server](#), you can start stream automatically.

1. Tap  on the main screen to start streaming.
2. Tap  on the main screen to stop streaming.

## How to check whether a sever is enabled with Quick Stream?

Tap  > Settings > Stream, and then if you can see a server is marked with an "Quick" tag, it means this server is enabled with Quick Stream.

## How to start a stream scheduled later for YouTube

When streaming to YouTube, you may need to preview the stream at first and then goes live as scheduled. You can follow the guide below.

1. Create a channel in your YouTube studio, and set the schedule.
2. Ensure that you have **NOT** enabled Auto-start.
3. Go to **Settings** > **Stream** on the device, and start configuring YouTube.
4. When configuring **Post To**, select the channel you have created in Step 1.
5. Save your configurations.
6. On the main screen, tap  to **start streaming** to YouTube.
7. On the popup window, select **Only Preview** to preview the stream at first.
8. In Live Control Room of YouTube, wait for the stream preview to show up, and then click **Go live**.

If you select **Go Live** in step 7, it streams to YouTube and goes live at once.

Besides, when you stop streaming, usually it ends live at once. If you want to pause streaming and keeps live, you can refer the following steps.

1. Go to your YouTube studio.
2. Ensure that you have **NOT** enabled Auto-stop.
3. On the main screen, tap  to **stop streaming** to YouTube.
4. On the popup window, select **Pause Streaming** to pause stream but keeps live. You can use the **END STREAM** button in Live Control Room of YouTube to end live.

If you select **End Live**, it stop streaming to YouTube and ends live at once.

## How many sources with video signal can I add to one scene/show?

### In the same scene

You can add a maximum of three video sources, including HDMI, WEBCAM, [SRT](#) stream, [RTMP](#) stream, [RTSP](#) stream, NDI stream, Phone Camera and video clips, in which:

- Each source can be added repeatedly except the video clip.
- You can only add one video layer, which can be a single video or a video slide show.
- If a video layer is added, you cannot add a picture slide show, vice versa.

Besides, you can only add one webpage in one scene.

### In the same show

- You can create up to 3 streams, including [RTMP](#), [SRT](#), [RTSP](#) and NDI. One NDI stream cannot be use by a scene and a GFX at the same time.
- You can create up to 3 Phone Cameras.

## What kind of video files can I use?

Supported Video Formats:

- With Alpha Channel:
  - WebM (VP8/VP9)
  - MOV (PNG/ProRes 4444)
- Without Alpha Channel:
  - WebM (VP8/VP9)
  - MOV (PNG/ProRes 4444/H.264/H.265)
  - MP4 (H.264/H.265)

## How do I confirm the video inputs are successfully connected?

Add a video source into a scene. If it displays the image normally, such source is connected successfully. For a Phone Camera, after your connect the phone with device, if the image taken by the phone displays in the scene, it is connected successfully.

## Encoding Policy for Streaming, Recording and Replay

1. Recording, streaming and replay can use up to 2 different encoders at the same time.
2. Different functions can share the same encoder, and only one encoder is counted when they are used at the same time.

### Supported encoding combinations:

- 2x NDI streaming
- 1x NDI streaming + 1x non-NDI streaming, 1x record, 1x replay (using the same encoder, such as Encode 1)
- 1x non-NDI streaming, 1x record, 1x replay (using Encode 1) + 1x non-NDI streaming, 1x record, 1x replay (using Encode 2)

## How to use the keyboard to enter in Chinese?

To enter in Chinese, please connect your device with the Internet, it will download the language package automatically.



## How to import and export files?

### Use USB flash drive and SD card

The supported file system types include: FAT32 (The maximum file size is 4 GB), exFAT, and NTFS.

- To import:  
When you add a video clip or picture source to a scene, add BGM, or add GFX, you can directly select files from the USB flash driver or SD card. These files are stored into the internal storage automatically. When you delete all the scenes or shows using these files, they will also be deleted from the internal storage.
- To export:
  1. Open the album.
  2. Tap **Select**, and then select one or more items.
  3. Tap  at the bottom, and then select USB or SD Card to export the selected items.

In this way, you can only export recorded video clips and screenshots.  
Please insert only one USB flash drive for exporting files.

- An SD card can be used to store recorded video clips and screenshots directly.
  - Tap  > **Settings** > **Record** > **Save path**, and select **SD Card First**. (Default)
  - Or tap  > **Settings** > **Storage** > **Record** or **Screenshot**, and then select **SD Card First**.

### Use computer

- Set the USB-C port to **MTP mode**, and use a Type-C cable to connect the USB-C OUT port of the device and the computer. The device is recognized as Director X, such as Director Mini, which may differ with the OS. Then you can import and export files with the computer. Please refer to [How to transfer files with computer via MTP mode](#).
- If an SD card is inserted into the device, the computer can also recognize it and perform read and write operations.

Recorded video clips, replay events and screenshots are stored in "\\Internal shared storage\\Director\\Director" or "\\SD card\\Director".

## Use Web UI

1. Connect the device to the network.
2. Swipe down from the top of the screen to open the Control Center, and then you can view the connected network and its IP address.
3. Using a computer on the same network, open a browser and access the specified IP address.
4. Or, you can find the Director device in the "File Explorer > Network" on a Windows computer on the same network. Double-click the device to access Web UI.
5. Or, you can enter `directormini.local` or `directorone.local` on the web browser to access Web UI. The device and computer are in the same LAN.
6. Enter the user name Admin and password Admin to log in.
7. Upload pictures, videos, music on the "Media" page.
8. When you browse files, such as adding BGM, you can find the uploaded files in the "System Media" folder.
9. For the files added to the show on the device, you can view and download them on the "Media" page of the Web UI. For the recording files, replay events and screenshots, you can view and download them on the "Album" page of the Web UI.

## Why are my recordings split into 4.0 GB clips?

Director device applies a default logic to prevent potential damage to the whole video to protect your content by breaking the recording into 4.0 GB clips. You can import video clips to the editing software, then merge them back together without any loss of data. You can also self-define to split recording files by time or by size, which has more options. For details, please refer to [Set Recording Properties](#).

## Why can't I log in to my YouTube account?

When you try to log in to your YouTube account, your login may fail with a message indicating that your account is not enabled for live streaming. In this case, you need to go to YouTube to enable live streaming for your account.

1. Log in to [YouTube](#) on your computer.
2. At the upper right corner on the YouTube home page, click  > Go live.
3. If you haven't, follow the prompts to verify your account.  
You will be prompted to enter your country and phone number.

After your account is verified, it takes 24 hours to activate your account for live streaming.

Once live streaming is activated, you can then successfully log in to your YouTube account in Director device and stream to YouTube.

For other information such as what you can stream to YouTube, you can go to the [YouTube official website](#).

### It does not show live comments from Twitch?

The live comments from Twitch are got via SDK. Twitch's SDK does not support binding network card, that is, it does not support setting network priority.

When the device is connected with multiple networks, to use one preferred network for streaming to Twitch while view live comments at the same time, please ensure that all these networks can access the official website of Twitch.

### It does not show live comments from Facebook?

To show live comments from Facebook, you need to share your content to Public audience. You can refer to [Choose who can see your post on Facebook](#).

### How to use the USB 3.0 ports?

Director device provides two USB 3.0 ports, which can accommodate a variety of usage scenarios.

The USB 3.0 ports support video input of webcam, USB microphone or audio playback device, and file transfer with a USB flash drive. The two ports can also connect Magewell USB Capture devices, with which you can connect a wider range of audio and video devices.

Moreover, they also allow various devices to connect, such as a USB modem for network connection, and a USB keyboard for [shortcuts control](#).

Tested USB Webcams that work in Director device:

- DJI Pocket 3
- DJI Osmo Action 3
- Logitech StreamCam
- ROCWARE RC08
- Insta 360 X3
- OBSBOT Tiny2
- OBSBOT Tail Air
- OBSBOT Tail 2
- Hamedal C10
- Magewell USB Capture



### WEBCAM Frame Rate Information

The USB 3.0 ports and USB-C port support connecting WEBCAM. The supported frame rate to capture is shown as follows.

WEBCAM Connection	Frame Rate
One WEBCAM to one USB 3.0 port	Up to 60 fps
One WEBCAM to the USB-C port	Up to 60 fps
Two WEBCAMs to two USB 3.0 ports	Up to 50 fps + 30 fps
One WEBCAM to one USB 3.0 port, one WEBCAM to the USB-C port	Up to 60 fps + 60 fps

## What can the USB-C OUT port be used for?

The USB-C OUT port is a USB 3.0 Type-C port, and provides multiple functions for free usage.

- Connect to computer to transfer file  
You can go to  > **Settings** > **USB Type-C**, to [set the USB-C port to MTP mode](#) to transfer files between Director device and the computer.
- Connect to computer to output audio and video  
You can go to  > **Settings** > **USB Type-C**, to [set the USB-C port to UVC + UAC mode](#) to output audio and video to streaming software, such as Zoom and Skype.
- Connect to a [USB Hub](#) for more usage  
You can use a [USB Hub](#) to connect WEBCAM for audio and video input, or connect a USB flash drive for file transfer, or a USB modem for network connection, or a USB keyboard for [shortcuts control](#), etc.
- Output audio and video to an external screen  
The USB-C port also serves a display port to connect to an external screen, such as a monitor and HDTV, supporting 1920x1080@60hz or 1920x1080@50hz, which changes along with the show's frame rate. You can use a Type-C to HDMI / VGA / DP adapter to connect the USB-C OUT port to the external screen, and select content to display on the external screen according to the prompt. It supports displaying clear program, preview, multi-view, duplicating the device screen, looping HDMI 1 or HDMI 2.

Besides, when Director device is connected to an external touchscreen and set to "Duplicate Screen", you can use the external touchscreen to control the device, so as to enlarge your canvas for better scene editing, annotation, etc.

For Director One, to use this function, you should go to  > **Settings** > **HDMI/DP Out**, and select **DP (USB-C) Out** as the display output port.

 Notice for using the external touchscreen to control Director device:

- The external touchscreen must support HID multi-touch function (no need of driver).
- Connect the touchscreen and Director device with a Type-C to Type-C cable. If you use a Type-C adapter, please connect the Touch Function port of the touchscreen to the device. For details, please refer to your touchscreen's user manual.
- Select Duplicate Screen as the displayed content.
- The external touchscreen should keep the full screen mode and the same orientation as the Director device.

## Mapping between the show's frame rate and each output frame rate

According to different frame rate of the show, the output frame rate or frame rate options related to recording, streaming, USB-C external screen and more will also be different, and the mapping relationship between them is shown in the following table.

Show	Frame Rate (fps)			
	USB-C DP-Out	Record	Streaming	Phone Camera
60	60	60, 30, 15	60, 30, 15	60, 30
59.94	60	59.94, 29.97	59.94, 29.97	59.94, 29.97
50	50	50, 25	50, 25	50, 25
30	60	30, 15	30, 15	30
29.97	60	29.97	29.97	29.97
25	50	25	25	25
24	50	24	24	24
23.98	50	23.98	23.98	23.98

## How to optimize encoding settings

Encoding parameters directly affects your final video output. Setting encoding parameters can be a tricky job, always a balancing act, a tradeoff between quality and bandwidth.

You will want to optimize each of the encoding parameters to deliver the best possible video quality.

### Resolution

Selecting a resolution is relatively easy. 1280x720 is considered HD resolution and 1920x1080 Full HD. 1920x1080 looks sharper but also requires more processing power and bandwidth.

### Frame rates

A wide range of frame rates are available for different use cases. For example, 25fps is usually used for PAL television systems, 29.97fps applies to NTSC television systems, while 24fps is mostly used when shooting and displaying movies.

Generally a higher frame rate provides smoother motion and crisper details. Videos with a lot of motions, such as sports events, will often need a higher frame rate. On the flipside, a high frame rate can put a lot of pressure on your device and network.

A lower frame rate can result in choppy or broken movement, but it puts less stress on your device and network, so it can also be a good choice in some cases, such as when no fast moving objects are present.

High-definition video generally employs 30fps/60fps. To start out, 30fps is a safe choice to get a nice, clean, and stable video.

### **Bitrate**

A higher bitrate can carry more data and often means better video quality, but you must have the bandwidth to accommodate it. Insufficient bandwidth in this case can result in dropped video frames, which can make the video choppy. Moreover, when the bitrate is already high enough for your video, increasing it further will not make an obvious difference for your video quality.

To set the bitrate properly, you have to factor in your network upload speed, device performance, resolution, and frame rate.

If your upload speed allows, you might want to set a bitrate that accommodates both high resolution and high frame rate to make your video look as sharp and smooth as possible. But if you have a limited upload speed, you may have to balance the resolution and frame rate. You need to make your choice based on your specific use case. For example, when your video features less motion but more detail, you might want a resolution of 1920x1080 and a frame rate of 30fps under limited bandwidth. When fast motions come first, streaming at 1280x720 and 60fps makes sense.

Different platforms also have their own recommendations for bitrates. You can click [Facebook](#), [Twitch](#), or [YouTube](#) to view the corresponding official guidelines.

### **Key frame interval**

A longer key frame interval means there will be less complete pictures, which can increase compression efficiency and reduce bandwidth consumption.

However, it can also result in longer time for switchover between different bit rates at the player side. For live streaming, 2 seconds is generally recommended for the right balance of quality and performance. For action-packed streams, you may want to try the interval of 1 second.

### **Audio**

Audio format includes sampling rate, codec format and bitrate. The suggested streaming format is 48khz, [aac](#), 128kbps.

### **Profile**

Profiles are a "family" of encoding techniques targeted for specific application scenarios. The three most commonly applied H.264 profiles are:

- Baseline: it includes I- and P-frames. This profile is designed for progressive video and supports CAVLC entropy coding. It is used primarily in low-cost

applications or those needing extra fault tolerance, for instant messaging scenarios such as video call, and mobile video.

- **Main:** it includes I-, P-, and B- frames. This profile is for progressive and interlaced videos, and supports CAVLC and CABAC entropy coding. It is used in videos for mainstream consumer electronic devices, such as MP4 with relatively low decoding rate, portable video player, PSP and iPod.
- **High:** it adds 8x8 internal prediction, custom quantification, lossless video encoding and more YUV formats (e.g., 4:4:4) on the basis of main profile. High profile is used for broadcast and video disc storage (Blu-ray movies), and HDTV applications.

### Bitrate mode

Among the different bitrate modes, **CBR** is the most predictable but generally yields videos of less satisfying quality. **VBR** involves more complex processing and can be slower, but it usually produces higher quality streams at similar bitrates.

Generally, it is recommended to use **VBR** for encoding. It gives you the best balance between quality and bandwidth consumption.

### Unable to control the camera using VISCA protocol

Some PTZ cameras use the Visca over IP protocol. For such cameras, enable the "Visca UDP message header" option when [setting PTZ control](#) while editing a scene. Refer to your camera's user manual to confirm if it supports Visca over IP.

### What to do when an NDI source jitters

If the image of an NDI source jitters, try the following steps:

1. **Check Network Stability:** Ensure you're on a stable network. If unstable, switch to a reliable connection.
2. **Adjust URL Settings in Scene Editor:**
  - Increase **Buffer Duration**.
  - Change **Transport Mode** from UDP to TCP or RUDP.
  - Enable **Ignore Video PTS**.

## Audio

### What audio inputs/outputs does Director device support?

Director device supports the following audio inputs and outputs:

#### Audio Input

- Mic/line in: 1x 3.5mm jack, 2-channel, 48 KHz, 16-bit
- Audio input from HDMI 1 and HDMI 2 ports: 2-channel, 48 KHz, 16-bit
- Audio input from USB port: 2-channel, 48 KHz, 16-bit
- Audio input from Bluetooth device: 2-channel, 48 KHz, 16-bit
- Audio input from Phone Camera
- Audio from [SRT](#) streams
- Audio from [RTMP](#) streams
- Audio from NDI streams
- Audio from [RTSP](#) streams
- Audio embedded in video files
- Audio from webpages
- Background music (BGM): MP3, M4A and WAV files

#### Audio Output

- Streaming and recording output: 2-channel, 48 KHz, 16 bit, [aac](#) format, 64/96/128kbps
- USB-C OUT port: 2-channel, 48 KHz, 16 bit
- HDMI OUT port (Director One): 2-channel, 48 KHz, 16 bit
- Monitor output, selecting one of the follows as the monitor
  - Bluetooth device: 2-channel, 48 KHz, 16 bit

- Headphone output: 1x 3.5mm jack, 2-channel, 48 KHz, 16 bit
- USB port: 2-channel, 48 KHz, 16-bit/24-bit/32-bit



### How do I adjust volume?

You can adjust audio volume when editing a scene, previewing the show and even during streaming and recording.

Tap  on the main screen or in the Scene Editor, to open the audio mixer. For details, see [Volume Control](#).







### Why is there no audio from the HDMI input?

Check whether Director device is selected as the audio output device on the source computer connected to the HDMI port. Only when Director device is selected will the computer output audio to Director device. The configuration varies depending on the OS.

For example, on Windows 10, click  >  > System > Sound. In the Output section, choose **Director X (\*\*\*\*\*)** from the drop-down list box of **Choose your output device**, such as **Director Mini (Intel(R) Display Audio)**.

### Why can I not hear the audio from my phone?

Please check by the following steps.

1. Tap  on the main screen or in the Scene Editor, and then check whether the audio of Phone Camera is set to . If yes, set it to  or .
2. In the Scene Editor, select the Phone Camera source. Tap **Property** on the bottom bar, and then check whether the **Microphone** is toggled on. If not, toggle it on.
3. Tap  on the Phone Camera screen of your phone, and it will turn to , which means the microphone is on.

## Settings

### Which AP band should I choose for hotspot?

1. The advantage of 2.4GHz is that it has a wider coverage area and stronger capability to penetrate solid objects. The main advantage of 5.0GHz is that the transmission rate is faster, which is 2~3 times that of the traditional 2.4GHz. And its anti-interference ability is stronger, which can avoid the interference of various electromagnetic waves in the daily environment.
2. Since most wireless devices currently use the 2.4GHz frequency band, they are often interfered in the daily environment. The signal will not be as good as 5.0GHz, and the network speed will also be affected. At present, most devices already support 5.0GHz. It is recommended to turn on 5.0GHz, so that it is not easy to be interfered, but at the same time, the power consumption of the device will be accelerated.
3. However, if your devices are separated by a distance, it is recommended to choose 2.4GHz, so that you can receive a better signal even across obstacles.

**Note:** When the Wi-Fi connected to the Director device is 5.0GHz, the AP band can only be selected as 2.4GHz; when the Wi-Fi is 2.4GHz, the AP band can only be selected as 5.0GHz.

## What to do when firmware update fails

### Possible causes:

1. The device is powered off or rebooted during the update.
2. The network is disconnected when the device is downloading the update file for auto update.
3. The device is out of storage space when downloading the update file for auto update.
4. The update file for manual update is not the correct file.

### Troubleshooting procedure:

1. Check whether Director device is powered off. Connect Director device with a power supply or install a fully charged battery.
2. For auto update, check whether the network connection is normal.
3. For auto update, check whether the storage space of the device is sufficient, and delete some files if necessary.
4. Check whether you have downloaded the right update file of Director device. Go to (<https://www.magewell.com/downloads>) to download the update file of Director device.
5. Update the firmware again.

DO NOT power off or reboot your device during the update.

If your issue is not solved, please submit your questions in the online Ticket System: [tickets.magewell.com](https://tickets.magewell.com), or contact the Magewell Technical Support Team at [support@magewell.net](mailto:support@magewell.net).

# Support

If you have problems or questions during using Director device, you can find support and help through the following ways.

## View Help

Tap  > **Help**, to get help information, which will tell you how to use Director device and give answers to some frequently asked questions.

## Feedback

You can use the feedback feature to ask technical questions, make suggestions and complaints.



### Submit New Feedback

1. Tap  > **Feedback** > **Submit new feedback**.
2. Select an Inquiry type: Technical question for product, Suggestion for a new feature, or Complaint.
3. Enter your personal information, such as First name (required), Last name, Email (required), Phone number, and Location.
4. Describe your problem with as many details as possible.
5. Add an attachment file.

A log file can help the support team analyze your problem. For how to get the log file, please refer to [Generate Log File](#).

6. Tick to agree privacy statements.
7. Enter the verification code.
8. Tap **Submit**, and then you will see a message saying Question Submitted Successfully.

## Generate Log File

1. Tap  > **Feedback** > **Generate log file**.
2. Tap **Start**.
3. Agree the privacy policy.
4. Tap **Go to home screen** to reproduce the issue you've encountered.
5. After you have finished reproducing the issue, tap  > **Feedback** to go back to the *Generate log file* page.
6. Tap **Stop**, and then a .zip file is generated in the internal storage.
7. (Optional) Tap **Export** to export it to the SD card or USB flash drive for more use.

## Check Submitted Feedback

1. Tap  > **Feedback** > **Submitted feedback**.
2. Enter your Email and tap **Track**.
3. Then you can see the feedback list, tap one feedback to check its status.

## Get the Latest Information

If you have any problems using Magewell products or need more technical information, please visit the [official website](#) for product introduction, user manual, and more.

## Technical Support

- Go to the [Knowledge Base](#) to find answers to your problem. If you cannot find an answer, click **Contact Us** at the bottom to contact the support team.
- Submit your questions in the online Ticket System: [tickets.magewell.com](https://tickets.magewell.com), or contact the Magewell Technical Support Team at [support@magewell.net](mailto:support@magewell.net).

# Notice

Copyright ©2025 [Nanjing Magewell Electronics Co., Ltd.](#)

All rights reserved. No part of this publication may be reproduced, distributed, or transmitted in any form or by any means, including photocopying, recording, or other electronic or mechanical methods, without the prior written permission of the publisher, except in the case of brief quotations embodied in critical reviews and certain other noncommercial uses permitted by copyright law.

## Trademarks

HDMI, the HDMI logo and High-Definition Multimedia interface are trademarks or registered trademarks of HDMI Licensing LLC. Windows is trademark or registered trademark of Microsoft Corporation. OS X and macOS are trademarks or registered trademarks of Apple Inc. NDI is trademark or registered trademark of Vizrt Group. Other trademarks and company names mentioned are the properties of their respective owners.

## About this Document

- This document is for reference only. Please refer to the actual product for more details.
- The user shall undertake any losses resulting from violation of guidance in the document.
- In case that PDF document cannot be opened, please upgrade the reading tool to the latest version or use other mainstream reading tools.
- This company reserves rights to revise any information in the document anytime; and the revised contents will be added to the new version without prior announcement. Some functions of the products may be slightly different before and after revision.
- The document may include technically inaccurate contents, inconsistencies with product functions and operations, or misprint. Final explanations of the company shall prevail.
- The only warranties for Magewell products and services are set forth in the express warranty statements accompanying such products and services. Nothing herein should be construed as constituting an additional warranty. Magewell shall not be liable for technical or editorial errors or omissions contained herein.

# Glossary and Abbreviations

## AAC

AAC (Advanced Audio Coding) refers to digital audio coding standard that represent audio files based on lossy audio compression. It was launched as successor of MP3 file format keeping in view that the lateral faced issues for the implementation of new ideas in the encoding process based on the development of methods for data compression. AAC achieves better sound quality as compared to MP3 at the same bit rate.

## AES

Advanced Encryption Standard (AES) is a specification for the encryption of electronic data.

## CBR

Constant bit rate. It means that your stream will be encoded using the selected bit rate over all the time.

## FTB

Fade to black. FTB allows your show to slowly disappear into a black, usually indicating the end of a scene or show.

## RTMP

RTMP stands for "Real-Time Messaging Protocol". It is an efficient way to transmit large chunks of audio, video, and data from a server to the Internet via an encoder. Most live video streaming relies on RTMP to deliver smooth, real-time playback.

## RTSP

RTSP stands for "Real-Time Streaming Protocol". It is a communication protocol used to control servers that stream media content over the Internet. It helps in setting up and managing connections between devices for streaming audio or video. RTSP ensures that media players and servers can communicate smoothly, allowing users to play, pause, adjust volume, and perform other actions while streaming content.

## SRT

SRT stands for "Secure Reliable Transport". It is an open source video transport protocol that utilizes the UDP transport protocol. It supports packet recovery while maintaining low latency. SRT also supports encryption using AES.

## SSID

SSID stands for "Service Set Identifier". Under the IEEE 802.11 wireless networking standard, a "service set" refers to a collection of wireless networking devices with the same parameters. So, the SSID is the identifier (name) that tells you which service set (or network) to join.

## USB Hub

USB hub refers to a device that expands one Universal Serial Bus (USB) port into several and enables those ports can be used at the same time. With this device, you don't have to worry about the port is not enough anymore.

## VBR

Variable bit rate. In this mode, the encoder dynamically increases or decreases the bit rate based on the image bitrate needs. VBR is preferred to CBR when you expect better image quality.